

B E G L E C

HITMUSIC

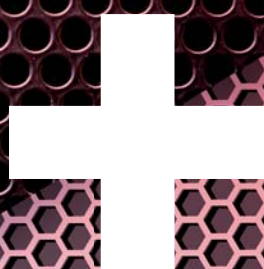

2018 EDITION

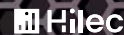

# EDITORIAL

The sum (+) of two companies is the right formula we have chosen for the coming years.

The BEGLEC HITMUSIC group combines its skills, talents, people, ranges, capacities and services to offer you more intense collaboration in the years to come.

This catalogue of the group, historic because it is the very first, illustrates perfectly the direction that we set ourselves and towards which we invite you to follow us. Together, only “+” in 2018!

**Pierre DENJEAN** – Partner BEGLEC NV – Chairman HIT MUSIC SAS

For several years we have been looking for a strategic partner to strengthen our company. With HIT MUSIC, we have found a partner who shares the same values and applies the same working methods. This is a very big step forward for both companies. It is with great energy and passion that we embark on this adventure. And dare we suggest that this is only the beginning of more things to come. The future will tell.

**Luc DE BAUW** – Partner BEGLEC NV – Director BEGLEC NV

With HIT MUSIC we have found a good partner for the future. An even greater challenge for the years to come. We can all do it together!

**Marc DE BAUW** – Partner BEGLEC NV

**ONLY**



**IN  
2018**

**4**

**BRANDS**  
BEGLEC

**2**

**BRANDS**  
HITMUSIC

**+**

**1**

**BRAND**  
ACCESSORIES

**=**

**7**

**exclusive**  
**BRANDS**

**BEGLEC**



**HITMUSIC**

**=**

**48**

**COUNTRIES**  
covered  
**IN 2017**

**10**

**TECHNICAL STAFF  
BEGLEC**



**7**

**TECHNICAL STAFF  
HITMUSIC**

**=**

**17**

**PEOPLE**

**for**

**TECHNICAL  
BACKUP &  
ENGINEERING**

**BEGLEC**

**31**

**YEARS**

**HITMUSIC**

**27**

**YEARS**



**58 YEARS**  
expertise &  
skills

**6000 M<sup>2</sup>**

BEGLEC  
IN BELGIUM



**4000 M<sup>2</sup>**

HITMUSIC  
IN FRANCE



**10 000 M<sup>2</sup>**

T O T A L  
S T O R A G E



**915**  
PRODUCTS  
BEGLEC



**1298**  
PRODUCTS  
HITMUSIC

**=**

**2213**  
PRODUCTS  
in this catalogue

## TECHNICAL DEPARTMENT

MARK AMERYCKX  
SYLVAIN TERROU

PIETER SEMPELS  
HUGO DE ROECK  
THOMAS ROMMELAERE

ERIC LAFAYE  
YOANN DELON

PATRICIA PANGRAZZI

# 17

MICHEL MOTTIER  
MARIO HEYLEN  
SABRY FREH  
THOMAS DEBOUCHE  
KOEN VAN DER AA  
JONATHAN GILLARD

RÉMY BEFFARA  
FABIEN DUPERRIN  
JACQUES DESMARIAUX

## IT & MARKETING DEPARTMENT

STEPHANE KOHN  
ARNAUD GARDERES

# 6

KRISTIN VANDIONANT  
THOMAS RIO  
MARIUS VANDEN CLOOSTER  
LOÏC GUILLIOUT

# 10

PHILIPPE BALLAND  
KEVIN BONNEFOY  
HERVÉ CAUVIN  
JACQUES LAVEYSSIERE

# = 57 SKILLED

# 3



# ASSOCIATES

LUC DE BAUW DIRECTEUR BEGLEC

PIERRE DENJEAN PRÉSIDENT HITMUSIC

MARC DE BAUW

# 14

## SALES DEPARTMENT

STEFAAN WINDEY  
JACKY MARTIN  
FILIP VERMANT

KEVIN VAN DER TAELEN  
OLIVIER PASTOR

YVES POLLET  
PETER VAN DEN ABBEELE

DANIEL NADIM  
DAVID SZYMANSKI  
DANIEL PICARD  
PHILIPPE PRENEAU  
LAURENT GAUDRY

CAROLE VINCENT  
HILDE VERSCHUERE

## LOGISTICS CENTER

PATRICE ESCUER  
STEVE GAORGIEVSKI  
OLIVIER PIETERS  
DIDIER VAN HOLME  
TOM CLEMENT  
GILLIAN JONVILLE

# 7

## ADMINISTRATION & FINANCE DEPARTMENT

FRANÇOISE FUSERO  
MARIE DO  
ISABELLE BABILLOTTE

JOCELYNE CALES  
INGE SCHELFHOUT  
FABIENNE RIVIERE  
SARAH LAGRING

# STAFF

# COMMERCIAL NETWORK

Find your commercial by sector

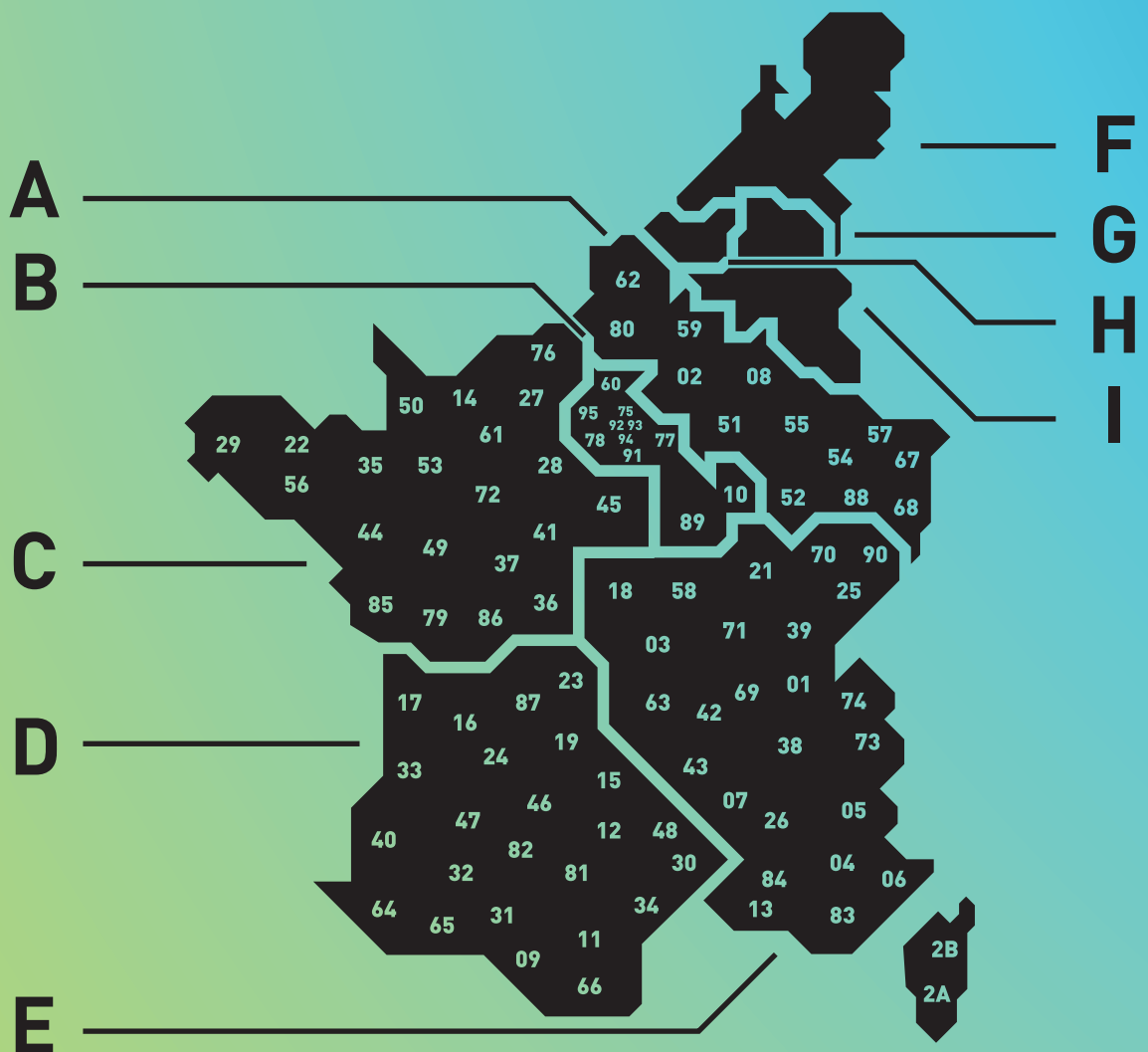

**A** NORTH-EAST FRANCE  
**David SZYMANSKI**

Tel. : +33 (0)6 74 53 93 51  
david.szymanski@hitmusic.eu

**B** PARIS  
PARIS AREA  
**Daniel NADIM**

Tel. : +33 (0)6 13 28 74 52  
daniel.nadim@hitmusic.eu

**C** NORTH-WEST FRANCE  
**Philippe PRENEAU**

Tel. : +33 (0)6 13 28 74 51  
philippe.preneau@hitmusic.eu

**D** SOUTH-WEST FRANCE  
**Laurent GAUDRY**

Tel. : +33 (0)6 13 28 74 54  
laurent.gaudry@hitmusic.eu

**E** SOUTH-EAST FRANCE  
**Daniel PICARD**

Tel. : +33 (0)6 13 28 74 53  
daniel.picard@hitmusic.eu

**F** THE NETHERLANDS

Tel. : +32 (0)2 481 70 70  
orders@beglec.com

**G** LIMBOURG / ANTWERP  
FLEMISH BRABANT  
**Filip VERMANT**

Tel. : +32 (0) 471 854 873  
vermant.filip@beglec.com

**H** EAST & WEST  
FLANDERS  
**Stefaan WINDEY**

Tel. : +32 (0) 472 325 224  
windey.stefaan@beglec.com

**I** WALLONIA / BRUSSELS  
LUXEMBURG  
**Jacky MARTIN**

Tel. : +32 (0) 473 505 779  
martin.jacky@beglec.com

 **EXPORT**

**Kevin VAN DER TAELEN**  
Tel. : +32 (0)2 481 70 70  
export@beglec.com

**Olivier PASTOR**  
Tel. : +33 (0)6 43 35 92 28  
olivier.pastor@hitmusic.eu

**HIT MUSIC SAS**

Parc d'Activités Cahors Sud  
En Teste  
46230 FONTAINES  
France  
Tel. : +33 (0)5 65 21 50 00  
contact@hitmusic.eu

**OPENING HOURS**

Monday → Friday  
9:00 to 12:00 & 13:15 to 17:15

**BEGLEC NV**

't Hofveld 2c  
Industriezone "Gosset"  
B-1702 Groot-Bijgaarden  
Belgique  
Tel. : +32 (0)2 481 70 70  
orders@beglec.com

**OPENING HOURS**

Monday → Friday  
8:30 to 12:15 & 13:00 to 17:00

# SUMMARY

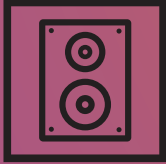

**P16**

SOUND



**P72**

PORTABLE SOUND

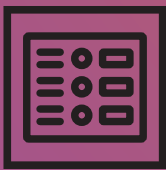

**P80**

COMMERCIAL AUDIO



**P100**

LIGHT INTEGRATION



**P126**

LIGHT



**P210**

EFFECT MACHINES



**P220**

FLIGHT-CASES



**P228**

TRUSS

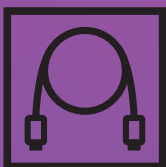

**P280**

ACCESSORIES

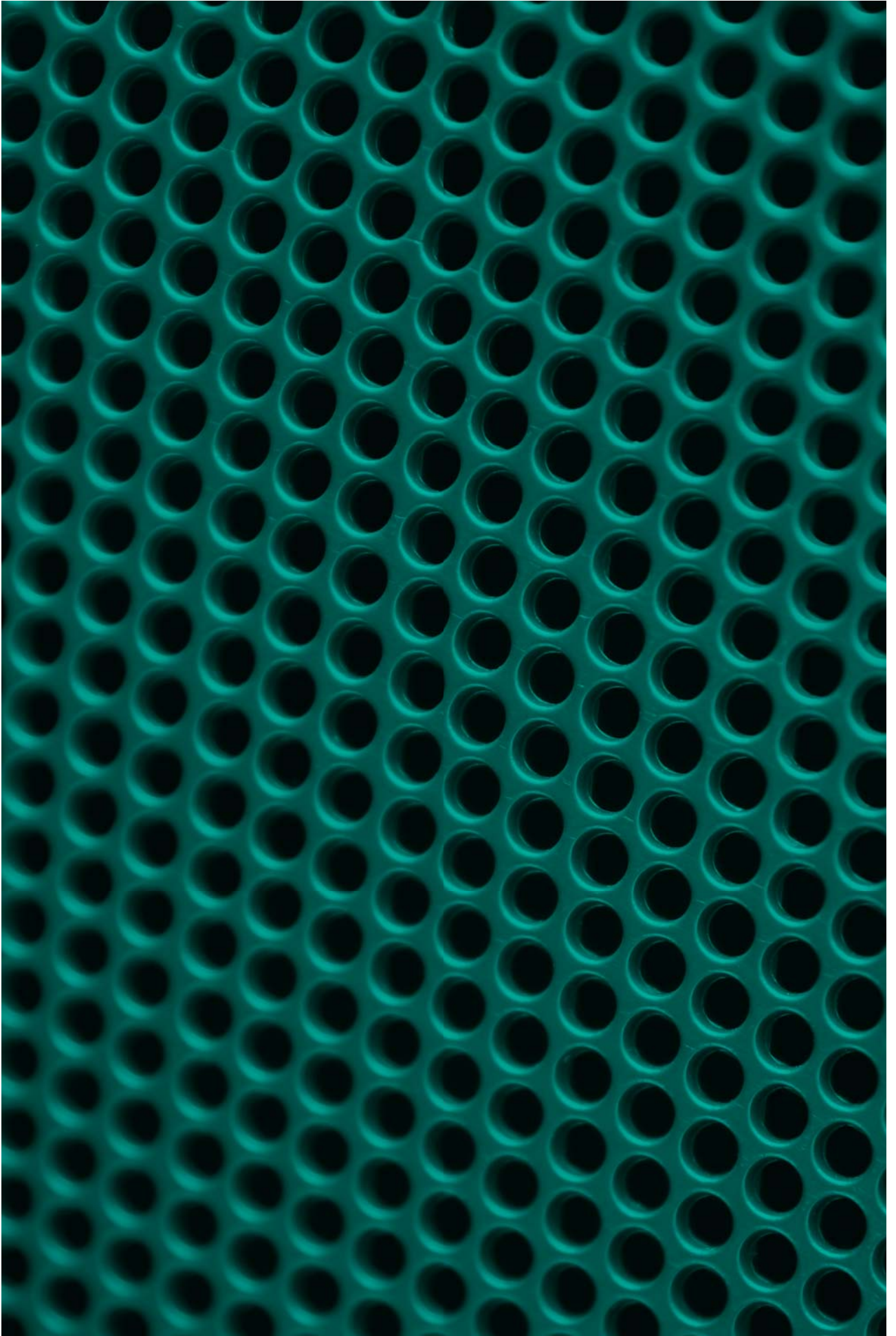



# SOUND

ACTIVE SYSTEMS  
ACTIVE SPEAKERS  
PASSIVE SPEAKERS  
SUBWOOFERS  
AMPLIFIERS  
SOUND PROCESSING  
MIXERS  
MIDI CONTROLLERS  
CD PLAYERS  
TURNTABLES  
WIRED MICROPHONES  
WIRELESS MICROPHONES  
HEADPHONES

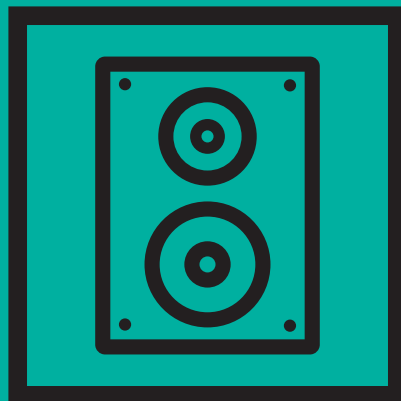

# ILINE COLUMN ARRAY

Complete iLINE COLUMN ARRAY set



## “Column Array” column systems

Aesthetically pleasing, the system comes with 2 families of columns. One for installation with columns iLINE23, iLINE43, iLINE83, and the other for stage performance with the iLiNE83B model.

They are linked and powered by an active subwoofer, the iLINEsub12A which embeds a double amplification of 700W/5 Ohms in class D for the columns and 700W/4 Ohms for the lower part because we can also add the iLINEsub12A as a reinforcement, which is the passive version of the subwoofer.

## Modulate your desires.

Whether for mobile or fixed use, the system answers all your problems.

The system offers multiple possible combinations, for example, 2 columns, 1 subwoofer or 2 subwoofers, 2 columns, etc.

Once controlled by an active subwoofer, the iLINEsub12P passive subwoofers can supply the satellites for numerous configurations.



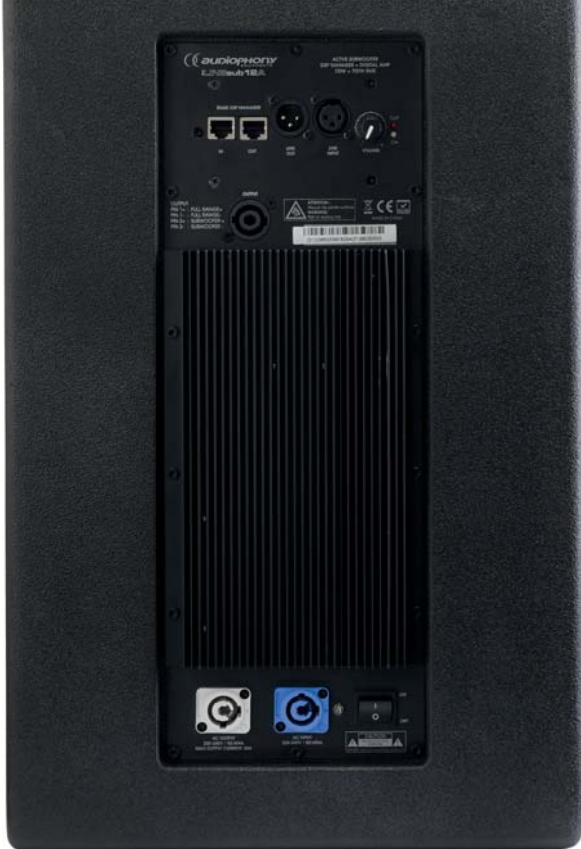

## A system that travels well.

Lightweight and robust, the subwoofers are made of a very resistant wood, Finnish birch multi-ply plywood with a protective polyurethane resin coating, which is very resistant to weather and scratches.

You can transport your entire iLINE system anywhere.

## Touch the power, that's all!

If you want to touch the system's sound settings, an "iLINEbox" USB to RJ45 converter is sold separately. This box is needed if you want to adjust the built-in DSP.

The native DSP is preset to factory settings in order to ensure optimal system behaviour.



Only compatible with Windows



# ILINE COLUMN ARRAY

Discover the different configurations available to purchase.



## iLINE

Stereo configuration 2.1 - 1020W

Code : H10879

1949 € incl. VAT



## iLINE

Mono configuration 510W

Code : H10880

979 € incl. VAT



## iLINE

Stereo configuration 2040W

Code : H10881

2999 € incl. VAT



## iLINE

Mono configuration 1020W

Code : H10882

1749 € incl. VAT



2x iLINE83 (H10756)  
2x iLINEsub12A (zH10761)  
1x iLINEbox (H10762)  
2x CAB-200 (H8245)  
2x CSP215/6 (H9841)

1x iLINE83B (H10758)  
1x iLINEspace60 (H10759)  
1x iLINEsub12A (H10761)  
1x iLINEbox (H10762)

4x iLINE83B (H10758)  
2x iLINEsub12P (H10763)  
2x iLINEsub12A (H10761)  
2x iLINEcord60 (H10764)  
1x iLINEbox (H10762)

2x iLINE83B (H10758)  
1x iLINEspace60 (H10759)  
1x iLINEbase (H10760)  
1x iLINEsub12P (H10763)  
1x iLINEsub12A (H10761)  
1x iLINEcord60 (H10764)  
1x iLINEbox (H10762)  
1x CSP215/3 (H9840)

**The RJ45 cord that connects the iLINEbox to the iLINEsub12A is not supplied.**

See the LINK-RJ cords in accessories section  
Available in multiple lengths





**iLINE**  
2680W stereo installation combination

---

Code : H10883      4499 € incl. VAT

---



8x iLINE83 (H10756)  
8x iLINE83sup (H10757)  
2x iLINEsub12P (H10763)  
2x iLINEsub12A (H10761)  
2x iLINEcord60 (H10764)  
1x iLINEbox (H10762)  
2x CSP215/3 (H9840)



**iLINE**  
940W stereo installation combination

---

Code : H10884      2099 € incl. VAT

---



4x iLINE43 (H10754)  
4x iLINE24sup (H10773)  
2x iLINEsub12A (H10761)  
1x iLINEbox (H10762)



**iLINE**  
510W mono installation combination

---

Code : H10885      1199 € incl. VAT

---



4x iLINE23 (H10752)  
4x iLINE23sup (H10753)  
1x iLINEsub12A (H10761)  
1x iLINEbox (H10762)



# ILINE COLUMN ARRAY



**iLINE83B**  
160W @ 16 Ohms column with 8 3-inch speakers - with stackable connector base

Code : H10758      249€ incl. VAT



**iLINE83**  
160W @ 16 Ohms column with 8 3-inch speakers for installation

Code : H10756      269€ incl. VAT



**iLINE83sup**  
Wall bracket for iLINE83 column

Code : H10757      39€ incl. VAT



**iLINE43**  
80W @ 8 Ohms column with 4 3-inch speakers for installation

Code : H10754      169€ incl. VAT



**iLINE43sup**  
Wall bracket for iLINE43 column

Code : H10755      35€ incl. VAT



**iLINE23**  
40W @ 16 Ohms column with 2 3-inch speakers for installation

Code : H10752      109€ incl. VAT



**iLINE23sup**  
Wall bracket for iLINE23 column

Code : H10753      29€ incl. VAT



**iLINE24sup**  
Adjustable wall bracket for iLINE23 and iLINE43

Code : H10773      69€ incl. VAT



	<b>iLINE23</b>	<b>iLINE43</b>	<b>iLINE83</b>	<b>iLINE83B</b>	<b>iLINEsub12A</b>	<b>iLINEsub12P</b>
Power	40W RMS / 80W Max	80W RMS / 160W Max	160W RMS / 320W Max	160W RMS / 320W Max	700+700 W RMS / 4Ω	400W RMS / 800W Max
Frequencies	135 Hz / 17 kHz	135 Hz / 17 kHz	135 Hz / 17 kHz	135 Hz / 17 kHz	50 Hz / 200 Hz	50 Hz / 200 Hz
Sensitivity	89 dB / 108 dB max	92 dB / 114 dB max	95 dB / 120 dB max	95 dB / 120 dB max	96 dB / 124 dB max	96 dB / 125 dB max
Impedance	16Ω	8Ω	16Ω	16Ω	8Ω	8Ω
Speakers	2x3"	4x3"	8x3"	8x3"	12"	12"
Dispersion HxV	115° / 20°	115° / 20°	115° / 20°	115° / 20°	-	-
Dimensions	110x180x148 mm	110x350x148 mm	110x690x148 mm	110x770x148 mm	350x515x490 mm	350x515x490 mm
Weight	2.2 Kg	4 Kg	7.6 Kg	7.6 Kg	23.5 Kg	22 Kg



**iLINEsub12P**  
12-inch passive subwoofer - 400W - 8 Ohms

Code : H10763      379€ incl. VAT



**iLINEsub12A**  
12-inch active subwoofer 700W + 700W with built-in DSP

Code : H10761      629€ incl. VAT



**iLINEspace60**  
Increase height by 60cm for iLINE83B with stackable connector base

Code : H10759      89€ incl. VAT



**iLINEbase**  
Floor bracket for iLINE83B and iLINESPACE60

Code : H10760      109€ incl. VAT



**iLINEcord60**  
Speakon cord/Speakon 60cm for iLINE series

Code : H10764      12€ incl. VAT



**iLINEbox**  
USB → RJ45 converter for DSP of iLINEsub12A

Code : H10762      29€ incl. VAT



**iLINEbag**  
Carrying bag for 2 iLINE 8 HP columns or 2 iLINEspace 60

Code : H10767      59€ incl. VAT



**iLINEcov**  
Protective cover for iLINE series subwoofers

Code : H10768      69€ incl. VAT



More information on  
[www.iline-series.audiophony.com](http://www.iline-series.audiophony.com)

# MINI LINE ARRAY HELIUM

## LINE-ARRAY HELIUM SERIES

A la carte system with choice of active subwoofer and passive heads.

The set can operate in mini line array and also in 2.1 on stands thanks to the optional accessories.

The Helium system is designed to meet the needs of installers who want to benefit from line array technology while maintaining ease of use and minimum space requirements.

The quality of the mid-high grain associated with the system's directivity creates a clear and precise diffusion.



### HL-10ASUB

Subwoofer for active compact line array  
2 x 10 inches - 400W RMS

Code : H10520 999€ incl. VAT



### HL-8ASUB

Subwoofer for active compact line array  
2 x 8 inches - 300W RMS

Code : H10519 899€ incl. VAT



### HL-4

Head for passive compact line array

Code : H10518 299€ incl. VAT



### HL-BUMPER

Suspension frame for hanging the complete line array

Code : H10521 109€ incl. VAT



### HL-FRAME

Support for hanging the HL-4 heads

Code : H10522 49€ incl. VAT



### HL-POLE

Base for HL-FRAME

Code : H10523 25€ incl. VAT



	HL-4	HL-8ASUB	HL-10ASUB
Power	100W RMS - 200W max	300W RMS - 600W max	Power rating: 400W RMS - 800W max
Frequency response	150 Hz - 25 KHz	80 - 200Hz	Frequency response: 50 - 200Hz
SPL max (to 1 m)	121 dB	110 dB	SPL max. (@1m) : 114 dB
Nominal impedance	16 Ω	4 Ω	Nominal impedance: 4 Ω
Woofer	2x4"	2 x 8 inches	Woofer: 2 x 10 inches
Tweeter	1x ribbon tweeter	-	
Dispersion	Pavilion waveguides (HxV) 120° x 30° to 90° depending on the cluster angle	-	
Connectors	IN/OUT speakon	-	
Dimensions	485x135x260 mm	485 x 540 x 260 mm	485 x 540 x 310 mm
Net weight	5.2 kg	19.2 kg	29.2 kg

### Amplification

Low level	-	2x 200W RMS / Class D - 8 Ω	2x 320W RMS / Class D - 4 Ω
Mid/high level	-	2x 200W RMS / class D - 8 Ω Set has a maximum of 800W	2x 200W RMS / class D - 8 Ω Set has a maximum of 1040W
Inputs	-	2x Combo XLR/Jack line level	2x Combo XLR/Jack line level
Outputs	-	2x Combo XLR/Jack line level 2x Speakon amplified for heads	2x Combo XLR/Jack line level 2x Speakon amplified for heads
Adjustments		Volume: Adjustment of the system's general level Bass: Adjustment of subwoofer level STEREO/PARALLEL selector for use in 2.1 or in Line array	



# MINI LINE ARRAY CUB



**"MODULARITY" IS THE KEY WORD FOR QUALIFYING THIS SYSTEM.**

Whether for fixed installation or mobile use, this new concept is very attractive.

The CUBsat4 speaker can of course be used alone in a classic multi-source installation but not only here, thanks to its ingenious integrated coupling and angulation system, you can make up your system very simply and thus obtain Line Array columns for up to eight speakers.



## CUBsat4

Head of 30W RMS mini line array

Code : H10663 129€ incl. VAT



## CUBsub112

12-inch passive 300W subwoofer

Code : H10664 249€ incl. VAT



## CUBsub208

300W RMS 8-inch 2 HP passive subwoofer

Code : H10665 279€ incl. VAT



## CUB-Wall1

Wall bracket for CUBsat4

Code : H10730 10€ incl. VAT



## CUB-Pole1

Foot support for CUBsat4

Code : H10731 59€ incl. VAT



## CUB-Truss1

Suspension support for CUBsat4

Code : H10732 39€ incl. VAT



	CUBsat4	CUBsub112	CUBsub208
Power	30W RMS - 90W max	300W RMS - 600W max	Power rating: 300W RMS - 600W max
Frequency response	100Hz -20KHz	45Hz -2.8KHz	Frequency response: 50Hz -800Hz
Filter	2 passive channels at 3kHz	The subwoofer is not equipped with a passive filter	Filter: the subwoofer is not equipped with a passive filter
SPL max. (@1m)	91 dB	125 dB	SPL max. (@1m) : 124 dB
Nominal impedance	8 Ω for a module with integrated impedance adapter.	8 Ω	Nominal impedance: 4 Ω
Woofer	4" to neodymium	12" to 64 mm coil	Woofer: 2 x 8" to 50 mm coil
Tweeter	3 x 0.5" soft dome	-	-
Dispersion	Pavilion waveguides (HxV) 110° x 20° for a module	-	-
Cluster orientation	0°/4°/8°/12°	-	-
Connectors	for 3x 6.35 input jack and parallel and series link	Connectors: for 2x speakon and terminal block for In/Out	
Construction	cast aluminium body and mounting bracket, pin and steel hinge. Black finish	Multi-ply subwoofer and metal grating Well for coupling bar on the top and rubber feet underneath Black finish	Well for coupling bar on the top and rubber feet underneath and wall mounting plates on the side. Black finish
Dimensions	170 x 140 x 150 mm	350 x 500 x 540 mm	250 x 510 x 540 mm
Net weight	1.450 kg	20 kg	18.5 kg

# THE MOJO RANGE

All in one active systems with mixer and Bluetooth® input



## MOJO500LINE

Active system subwoofer and column + mixer with 1 Bluetooth® input

Code : H10529

499€ incl. VAT



## COV-MOJO500LINE

Protective cover for MOJO500LINE

Code : H10867

99€ incl. VAT



Power rating: 200W for the column + 300W for subwoofer
Frequency response: 50Hz -22KHz
SPL max. (@1m) : 116 dB
Woofer: 6 x 2.75" for the column + 1x8" for the subwoofer
Dispersion : 120° x 20° (HxV)
Connectors: 2x Combo Mic/Line + 1x RCA Line et 1x 3.5 Jack Line
Bluetooth® receiver on channel 3
Adjustments: Volume by channel + general Treble/Bass
Dimensions : (80 x 80 x 830 mm) x2 for the column and support 340 x 430 x 400 mm for the subwoofer
Net weight: 3.65 kg + 10.8 kg



The set weighs less than 20 kg and takes up very little space in a car boot.

Power rating: 320W for the satellites + 700W for the subwoofer
Frequency response: 50Hz -22KHz
SPL max. (@1m) : 120 dB
Woofer: 4.75" for the satellite + 1x10" for the subwoofer
Tweeter: 1" compression
Dispersion: 90° x 45° (HxV)
Connectors: 1x Mic/Line Combo + 1x Guitar/microphone jack + 2x line Jack and 1x 3.5 Auxiliary Line Jack
Bluetooth® receiver on channel 3
Adjustments: Volume and effect by channel + general Treble/Bass + subwoofer volume
Multi-effects DSP Reverb Plate/ Plate2/Room/Room2/Hall/Hall2, Delay, Vocal doubler
Dimensions : (225 x 140 x 110 mm) x2 for the satellites 345 x 450 x 400 mm for the subwoofer
Net weight: 3.8 kg + 14.5 kg



## MOJO1000FX

Active Subwoofer and satellites system + multi-effects DSP and a Bluetooth® input

Code : H10528

729€ incl. VAT



## COV-MOJO1000FX

Travel bag + trolley for MOJO1000FX

Code : H10350

119€ incl. VAT



# CPX SYSTEM

500W compact active audio system for all types of applications.



## CPX-1510 FULL SET

500W compact active audio system

Code : B00613

729€ incl. VAT



Power: 200W for satellites column + 300W for subwoofer

Frequency response: 35Hz -20KHz

SPL max. (@1m): 128 dB

Woofer: 10" for the satellite + 15" for the subwoofer

Tweeter: 1" compression

Dispersion: 90° x 70° (HxV)

Connectors: 2x XLR/line Jack input + 2x Speakon output

Adjustments: Satellite volume + subwoofer volume

Dimensions : (435x 305 x 440 mm) x2 for the satellites  
440 x 600 x 590 mm for the subwoofer

Net weight: 19.5 kg + 42.8 kg

## CPX-1510SAT (pair)

Two 10" satellite speakers

Code : B00611

219€ incl. VAT



Power: 200W

Frequency response: 100Hz -20KHz

SPL max. (@1m): 120 dB

Woofer: 10"

Tweeter: 1" compression

Dispersion: 90° x 70° (HxV)

Connectors: 2x Speakon

Dimensions: 435x 305 x 440 mm x2

Net weight: 19.5 kg



# ATOM ACTIVE SPEAKERS



The ATOM series is equipped with a simple DSP and is easy to use. It allows you to adjust and configure your speaker to the required use with the touch of a button. The internal processor's different presets adapt your speaker to the current use (front, backstage, etc.) but also the current sound application (DJ, Live, Speech, etc.) without forgetting the ability to correct bass and treble +/- 10dB in order to compensate for a room's acoustic problems, for example.

Each ATOM speaker offers two inputs and one output, a large choice of connectivity in order to connect all kinds of sources at Micro or Line level.



The design of this new series provides usage flexibility and exceptional installation thanks to M10 attachment points, backstage position and an ingenious 35mm double position base allowing the speaker to be used on a stand in a straight or inclined position of 7.5° downwards.





**NEW**



**ATOM15A**  
15-inch active speaker with DSP

Code : H10781      449€ incl. VAT



**NEW**



**ATOM12A**  
12-inch active speaker with DSP

Code : H10780      379€ incl. VAT



**NEW**



**ATOM10A**  
10-inch active speaker with DSP

Code : H10779      359€ incl. VAT



**NEW**



**COV-ATOM15A**  
Protective cover for ATOM15A

Code : H10786      79€ incl. VAT



**NEW**



**COV-ATOM12A**  
Protective cover for ATOM12A

Code : H10785      69€ incl. VAT



**NEW**



**COV-ATOM10A**  
Protective cover for ATOM10A

Code : H10784      65€ incl. VAT



	<b>ATOM15A</b>	<b>ATOM12A</b>	<b>ATOM10A</b>
CODE	H10781	H10780	H10779
Total power	400 W RMS - 1600 W DYNAMIC	400 W RMS - 1600 W DYNAMIC	300 W RMS - 1200 W DYNAMIC
Amplification class	D + AB	D + AB	D + AB
Power supply	SMPS switched-mode	SMPS switched-mode	SMPS switched-mode
Protection	Limiter, thermal and short-circuit	Limiter, thermal and short-circuit	Limiter, thermal and short-circuit
Frequency response	45 Hz to 20 kHz	50 Hz to 20 kHz	60 Hz to 20 kHz
Dispersion H x V	90° x 60°	90° x 60°	90° x 60°
SPL pressure	124 dB max	123 dB max	121 dB max
Woofers	15" of 3" coil	12" of 3" coil	10" of 2.5" coil
Tweeter	1.35"	1.35"	1"
Pre-amplification	1 MIC/LINE input on XLR/Jack Combo 1 LINE Input on RCA and 3.5 Jack	1 MIC/LINE input on XLR/Jack Combo 1 LINE Input on RCA and 3.5 Jack	1 MIC/LINE input on XLR/Jack Combo 1 LINE Input on RCA and 3.5 Jack
	Line output on XLR		
	Volume adjustment per channel		
DSP	Equalisation presets: Normal, Live, Club and Speech Position presets: feet, feedback, wall Treble and bass graphic equaliser		
Dimensions (H x W x D)	730 x 425 x 415 mm	628 x 365 x 355 mm	531 x 310 x 300 mm
Net weight	20.6 kg	17.3 kg	11.3 kg



# SR ACTIVE SPEAKERS

The SR series speakers have been designed for multi-purpose and intensive use. The four Presets offer effective protection and settings for all kinds of uses whether at the front, backstage, DJ set or Live.





**SR15A**  
Amplified 2-channel speaker - Bass reflex  
400 Watts RMS

Code : H10159      399€ incl. VAT

**SR12A**  
Amplified 2-channel speaker - Bass reflex  
400 Watts RMS

Code : H10158      329€ incl. VAT

**SR10A**  
Amplified 2-channel speaker - Bass reflex  
300 Watts RMS

Code : H10157      279€ incl. VAT





**COV-SR15**  
Cover for SR15A speaker

Code : H10169      79€ incl. VAT





**COV-SR12**  
Cover for SR12A speaker

Code : H10168      69€ incl. VAT

**COV-SR10**  
Cover for SR10A speaker

Code : H10167      65€ incl. VAT



	SR15A	SR12A	SR10A
CODE	H10159	H10158	H10157
Total power	400 W RMS - 800 W MAX	400 W RMS - 800 W MAX	300 W RMS - 600 W MAX
Amplification class	D + AB		
Power supply	SMPS switched-mode		
Protection	Limiter, thermal and short-circuit		
Frequency response	40 Hz to 20 kHz	45 Hz to 20 KHz	55 Hz to 20 kHz
Dispersion H x V	90° x 60°	90° x 60°	90° x 60°
SPL pressure	124 dB max	123 dB max	121 dB max
Woofer	15" of 3" coil	12" of 3" coil	10" of 2.5" coil
Tweeter	1.35"	1.35"	1"
Pre-amplification	1 MIC/LINE input on XLR/Jack Combo Line output on XLR General volume adjustment Flat, Live, DJ and Vocal equalisation presets		
Dimensions (H x W x D)	410 x 450 x 710 mm	360 x 400 x 630 mm	310 x 335 x 530 mm
Net weight	21.1 kg	19.2 kg	13.4 kg

# SX ACTIVE SPEAKERS



SX speakers are professional and multi-purpose. The choice of components combined with bi-amplification brings a rich and precise sound. The input connector is linked with an optional Bluetooth module that allows easy use with a smartphone or tablet.



**NEW**



**SX15A**  
300W 15-inch 2-channel active speaker

Code : H10778      299€ incl. VAT



**NEW**



**SX12A**  
300W 12-inch 2-channel active speaker

Code : H10777      249€ incl. VAT



**NEW** Bluetooth



**SX-BT**  
Bluetooth module for SX speaker

Code : H10886      29€ incl. VAT



**NEW**



**COV-SX15A**  
Protective cover for SX15A

Code : H10855      79€ incl. VAT



**NEW**



**COV-SX12A**  
Protective cover for SX12A

Code : H10854      69€ incl. VAT



	SX15A	SX12A
CODE	H10778	H10777
Total power	300 W RMS - 600 W MAX	300 W RMS - 600 W MAX
Amplification class	D	D
Power supply	SMPS switched-mode	SMPS switched-mode
Protection	Limiter, thermal and short-circuit	Limiter, thermal and short-circuit
Frequency response	50 Hz to 20 kHz	55 Hz to 20 kHz
Dispersion H x V	90° x 60°	90° x 60°
SPL pressure	121 dB max	120 dB max
Woofers	15" of 2" coil	12" of 2" coil
Tweeter	1.35"	
Pre-amplification	1 MIC/LINE Input on Combo and RCA Line output on XLR General volume adjustment "Contour" Preset	
Optional module	Bluetooth® receiver 4.0 Pairing, Play/Pause, Skip, Vol buttons	
Dimensions (H x W x D)	630 x 390 x 370 mm	600 x 380 x 340 mm
Net weight	14.5 kg	13.2 kg

# PSA ACTIVE SPEAKERS



- Bi-Amping technology with separate amplifiers
- Active two-channel filter
- 2 balanced MIC inputs + 1 LINE input with level adjustment
- Balanced LINE output
- Adjustment buttons for treble + bass + main volume



**PSA-15**  
15" active professional speaker

Code : B00617 259€ incl. VAT



**PSA-12**  
12" active professional speaker

Code : B00616 219€ incl. VAT



**PSA-10**  
10" active professional speaker

Code : B00629 189€ incl. VAT



**PSA-08**  
8" active professional speaker

Code : B00628 169€ incl. VAT



**TOURING BAG - PS-15/PSA-15**  
Cover for PS-15/PSA-15

Code : B00597 49€ incl. VAT



**TOURING BAG - PS-12/PSA-12**  
Cover for PS-12, PSA-12, PPA-121

Code : B00596 39,90€ incl. VAT



	PSA-15	PSA-12	PSA-10	PSA-08
Code	B00617	B00616	B00629	B00628
Total RMS power	245+55 W	165+35 W	130+30 W	120 W
Frequency response	40 Hz to 20 kHz	45 Hz to 20 KHz	60 Hz to 20 KHz	70 Hz to 20 KHz
Dispersion H x V	90° x 60°	90° x 60°	90° x 60°	90° x 60°
Woofer	15"	12"	10 inch	08 inch
Tweeter	1.75"	1.35"	1.35 inch	1 inch
Pre-amplification	1 MIC Input on XLR and RCA 1 LINE Input on RCA and XLR Line Output on XLR and JACK General volume and Mic and Line volume adjustment General Treble and Bass adjustment			
Dimensions (H x W x D)	680 x 470 x 400 mm	588 x 431 x 310 mm	500 x 355 x 270 mm	402 x 294 x 220 mm
Net weight	23.3 kg	17 kg	11.6 kg	8 kg



# MONITORS



**ACUTE08/AMP**  
150W active 8" moulded speaker

Code : H8738 229€ incl. VAT



**SUP-AC08N0**  
ACUTE08 monitor hanging bracket - black

Code : H8738 39€ incl. VAT



	ACUTE08/AMP
CODE	H8738
Total power	150 W RMS - 300 W MAX
Amplification class	D
Power supply	Toroidal
Protection	Limiter, thermal and short-circuit
Frequency response	70 Hz to 18 kHz
Dispersion H x V	90° x 60°
SPL pressure	117 dB max
Woofers	8" of 2" coil
Tweeter	1"
Pre-amplification	1 MIC Input on Jack 1 Input LINE on XLR Line output on XLR Mic and Line volume adjustment
Dimensions (H x W x D)	435 x 255 x 245 mm
Net weight	9.5 kg



**AM50**  
Set of active 5" studio monitors, equipped with a 2 x 35 W RMS amp

Code : B00623 234,90€ incl. VAT



	AM50
CODE	B00623
Total power	2x35 W RMS
Frequency response	65 Hz to 20 kHz
Woofers	5" Kevlar
Tweeter	3/4" soft dome
Pre-amplification	1 LINE Input on 3.5 Jack
	Line Output on RCA Amplified left output on terminal block
	General volume adjustment
Dimensions (H x W x D)	180 x 258 x 209 mm
Net weight	6.3 kg

# SC PASSIVE SPEAKERS

- Passive speakers for “high-end” performance
- Designed, developed and manufactured in Europe
- European components assembled in Hi-end coaxial speakers
- High quality Baltic birch plywood and polyurethane with coating of “Chemline” (USA) anti-scratch paint
- Very powerful and excellent performance

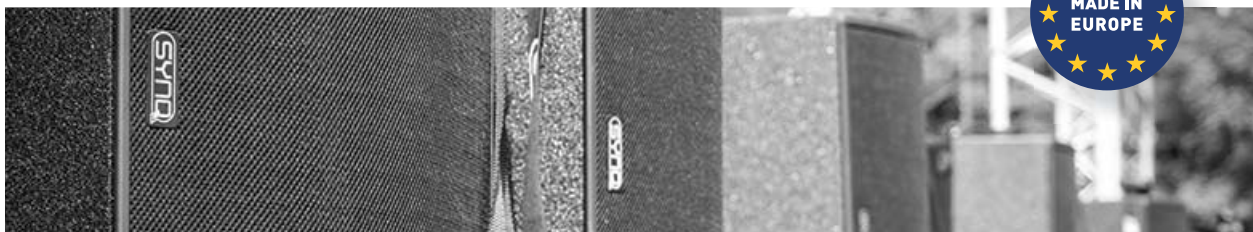

**SC-15**  
15" 2-channel 400 WRMS speaker

Code : B09183      909€ incl. VAT



**SC-12**  
12" 2-channel 400 WRMS speaker

Code : B09182      839€ incl. VAT



**SC-08**  
8" 2-channel 300 WRMS speaker

Code : B09181      689€ incl. VAT



**SC-05**  
5" 2-channel 250 WRMS speaker

Code : B09180      439€ incl. VAT



SC-15	SC-12	SC-08	SC-05
2-channel passive filter	2-channel passive filter	2-channel passive filter	2-channel passive filter
15" low frequency speaker with ferrite + 1.45" tweeter (1" coil)	12" low frequency speaker with ferrite + 1.45" tweeter (1" coil)	8" low frequency speaker with ferrite + 1.45" tweeter (1" coil)	5" low frequency speaker with ferrite + 1.75" tweeter (0.75" coil)
3 Speakons	3 Speakons	Speakon in/out 4-pin	Speakon in/out 4-pin + Euroblock 4-pin connector
Switch selection + -1 or + -2	Switch selection + -1 or + -2	Switch selection + -1 or + -2	Switch selection + -1 or + -2
Enclosure in multi-ply Finnish birch	Enclosure in multi-ply Finnish birch	Enclosure in multi-ply Finnish birch	OMEGA® fastening hook
Resistant textured black paint	Resistant textured black paint	Resistant textured black paint	Can be attached to a microphone stand using the U-bracket
Max SPL: 128dB	Max SPL: 128dB	Max SPL: 123dB	Max SPL: 119dB
Bandwidth: 54-19.000Hz (-3dB)	Bandwidth: 60-20.000Hz (-3dB)	Bandwidth: 70-20.000Hz (-3dB)	Bandwidth: 120-21.000Hz (-3dB)
Polarity: 60° x 40°	Polarity: 60° x 40°	Polarity: 90° cone	Polarity: 70° cone
Power rating: 400 W AES (recommend amplifier: 800W RMS)	Power rating: 400 W AES (recommend amplifier: 800W RMS)	Power rating: 300 W AES (recommend amplifier: 600W RMS)	Power rating: 250 W AES (recommend amplifier: 500W RMS)
Impedance: 8 Ω	Impedance: 8 Ω	Impedance: 8 Ω	Impedance: 16 Ω
Dimension : 368x580x447 mm	Size: 351x540x410 mm	Dimensions: 254x420x250 mm	Size: 165x165x165 mm
Weight: 19 kg	Weight: 16 kg	Weight: 8 kg	Weight: 4 kg

Accessories for attachments and flight cases available, see accessories section

# VIBE PASSIVE SPEAKERS



- Ideal for fixed installations in bars, clubs
- Very solid MDF enclosure
- Covered with metal grid and with acoustic foam inside
- Fibreglass pavilion

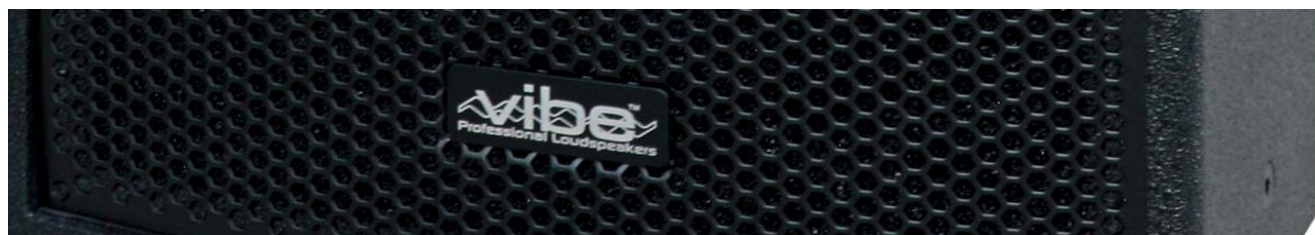

**VIBE30 MK2**  
Pro. speaker : 2x 15" - 800Wrms / 4 Ω

Code : B00693      489€ incl. VAT



**VIBE15 MK2**  
Pro. speaker : 15" - 350Wrms / 8 Ω

Code : B00692      329€ incl. VAT



**VIBE12MK2**  
Pro. speaker : 12" - 250Wrms / 8 Ω

Code : B00691      249€ incl. VAT



**VIBE10MK2**  
Pro. speaker : 8" - 150Wrms / 8 Ω

Code : B00689      189€ incl. VAT



**VIBE8 MK2**  
Pro. speaker : 2x 15" - 800Wrms / 4 Ω

Code : B00689      149€ incl. VAT



**CLS-8 II**  
8" compact high power speaker

Code : B00630      299€ incl. VAT



**TOURING BAG**      **TOURING BAG**      **TOURING BAG**  
Travel bag for Vibe 30      Travel bag for Vibe 15      Travel bag for Vibe 12

Code : B00593      82,50€ incl. VAT      Code : B00592      54,90€ incl. VAT      Code : B00591      39€ incl. VAT



VIBE30 MK2	VIBE15 MK2	VIBE12 MK2	VIBE10 MK2	VIBE8 MK2	CLS-8 II
Power rating: 800WRMS	Power rating: 350WRMS	Power rating: 250WRMS	Power rating: 200WRMS	Power rating: 150WRMS	Power rating: 200 WRMS
Impedance: 4 Ω	Impedance: 8 Ω	Impedance: 8 Ω	Impedance: 8 Ω	Impedance: 8 Ω	Impedance: 8 Ω
Max performance (dB) : 131	Max performance (dB) : 125	Max performance (dB) : 122	Max performance (dB) : 120	Max performance (dB) : 120	-
Bandwidth (Hz) : 40-20000	Bandwidth (Hz) : 45-20000	Bandwidth (Hz) : 55-20000	Bandwidth (Hz) : 65-20000	Bandwidth (Hz) : 65-20000	Bandwidth (Hz) : 70-20,000
Dimensions (cm) : 116 x 49 x 50.3	Dimensions (cm) : 76 x 47 x 43.5	Dimensions (cm) : 62 x 38.2 x 34.5	Dimensions (cm) : 33 x 51 x 30.2	Dimensions (cm) : 46.5 x 27.7 x 27	Dimensions (cm) : 46.0 x 28.6 x 27.6
Weight (kg) : 50	Weight (kg) : 29	Weight (kg) : 20	Weight (kg) : 15	Weight (kg) : 12	Weight (kg) : 13

# SR & ACUTE PASSIVE SPEAKERS





**SR15P**  
15" 300W plastic moulded passive speaker  
- GOA series

Code : H10270      299€ incl. VAT

**SR12P**  
12" 300W plastic moulded passive speaker  
- GOA series

Code : H10269      269€ incl. VAT

**SR10P**  
10" 200W plastic moulded passive speaker  
- GOA series

Code : H10268      199€ incl. VAT



**ACUTE-08NO**  
8" passive plastic speaker

Code : H9595      159€ incl. VAT



**ACUTE-08WH**  
8" passive plastic speaker white

Code : H9596      169€ incl. VAT





**SUP-AC08NO**  
ACUTE08 monitor hanging bracket - black

Code : H9598      39€ incl. VAT



**SUP-AC08WH**  
ACUTE08 monitor hanging bracket - white

Code : H9599      39€ incl. VAT



SR15P	SR12P	SR10P	ACUTE-08
Output power: 350W RMS / 700W max.	Output power: 350W RMS / 700W max.	Output power: 250W RMS / 500W max.	Output power: 150 W RMS
Frequency response: 45 Hz - 20 KHz	Frequency response: 55 Hz - 20 KHz	Frequency response: 65 Hz - 20 KHz	Frequency response: 70 Hz - 18 KHz
Impedance: 8 Ω	Impedance: 8 Ω	Impedance: 8 Ω	Impedance: 8 Ω
SPL: 96 dB max.	SPL: 96 dB max.	SPL: 94 dB max.	SPL: 94 dB max.
Dimensions: 410 x 450 x 710 mm	Dimensions: 360 x 400 x 630 mm	Dimensions: 310 x 335 x 530 mm	Dimensions: 435 x 255 x 245 mm
Net weight: 19.2 Kg	Net weight: 17.8 Kg	Net weight: 11.8 Kg	Net weight: 8 kg

# PS PASSIVE SPEAKERS



**PS-15**  
15" passive 300Wrms/8Ω speaker

---

Code : B00610      169€ incl. VAT

---





**PS-12**  
12" passive 200Wrms/8Ω speaker

---

Code : B00609      129€ incl. VAT

---





**PS-10**  
10" passive 160Wrms/8Ω speaker

---

Code : B00627      99€ incl. VAT

---





**PS-08**  
8" passive 120Wrms/8Ω speaker

---

Code : B00626      79€ incl. VAT

---



**TOURING BAG -  
PS-15/PSA-15**  
Cover for PS-15/PSA-15

---

Code : B00597      49€ incl. VAT

---



**TOURING BAG -  
PS-12/PSA-12**  
Cover for PS-12, PSA-12, PPA-121

---

Code : B00596      39,90€ incl. VAT

---



PS-15	PS-12	PS-10	PS-08
Output power: 300W RMS / 600W max.	Output power: 200W RMS / 400W max.	Output power: 160W RMS / 320W max.	Output power: 120 W RMS / 240W max.
Frequency response: 45 Hz - 20 KHz	Frequency response: 45 Hz - 20 KHz	Frequency response: 60 Hz - 20 KHz	Frequency response: 70 Hz - 20 KHz
Impedance: 8 Ω	Impedance: 8 Ω	Impedance: 8 Ω	Impedance: 8 Ω
Dimensions: 680 x 470 x 400 mm	Dimensions: 580 x 420 x 310 mm	Dimensions: 500 x 355 x 270 mm	Dimensions: 402 x 290 x 220 mm
Net weight: 19.8 Kg	Net weight: 13.2 Kg	Net weight: 10.3 Kg	Net weight: 6.6 kg

# PASSIVE SPEAKERS



## iLINE83

160W column/ 16 Ω with 4 HP 3" for installation

Code : H10756

269€ incl. VAT



## iLINE83sup

Wall bracket for iLINE83 column

Code : H10757

39€ incl. VAT



## iLINE43

80W column/ 8 Ω with 4 HP 3" for installation

Code : H10754

169€ incl. VAT



## iLINE43sup

Wall bracket for iLINE43 column

Code : H10755

35€ incl. VAT



## CUBsat4

Head of 30W RMS mini line array

Code : H10663

129€ incl. VAT



## iLINE23

40W column/ 16 Ω with 2 HP 3" for installation

Code : H10752

109€ incl. VAT



## iLINE23sup

Wall bracket for iLINE23 column

Code : H10753

29€ incl. VAT



## iLINE24sup

Adjustable wall bracket for iLINE23 and iLINE43

Code : H10773

69€ incl. VAT



## HL-4

2x4" mini line array head + TWT ribbon

Code : H10518

299€ incl. VAT



	iLINE23	iLINE43	iLINE83	CUBSAT4	HL-4
Power	40W RMS / 80W MAX	80W RMS / 160W MAX	160W RMS / 320W MAX	300W RMS - 600W max	100W RMS - 200W max
Response Response	135 HZ / 17 KHZ	135 HZ / 17 KHZ	135 HZ / 17 KHZ	50Hz - 800Hz	150 Hz - 25 KHz
Sensitivity	89 DB / 108 DB MAX	92 DB / 114 DB MAX	95 DB / 120 DB MAX	124 dB	121 dB
Impedance	16Ω	8Ω	16Ω	4 Ω	16 Ω
Speakers	2X3"	4X3"	8X3"	1X4" + 3X0.5"	2X4" + RIBBON
Dispersion HxV	115° / 20°	115° / 20°	115° / 20°	110° / 20°	120° x 30° to 90°
Dimensions	110X180X148 mm	110X350X148 mm	110X690X148 mm	250 x 510 x 540 mm	485x135x260 mm
Weight	2.2 kg	4 kg	7.6 kg	18.5 kg	5.2 kg

# S SERIES PASSIVE SPEAKERS



**S6**  
Passive 6.5P 80W RMS monitor - black

Code : H9689 159€ incl. VAT



**S6W**  
Passive 6.5P 80W RMS monitor - white

Code : H9690 159€ incl. VAT



**S8**  
Passive 8P 120W RMS monitor - black

Code : H9691 269€ incl. VAT



**S8W**  
Passive 8P 120W RMS monitor - white

Code : H9692 269€ incl. VAT



**S10**  
Passive 10P 250W RMS monitor - black

Code : H9693 349€ incl. VAT



**S10W**  
Passive 10P 250W RMS monitor - white

Code : H9694 349€ incl. VAT



**ISX-10 (pair)**  
Compact 2-channel trapezoidal speaker  
Price for the pair

Code : B00619 239€ incl. VAT



**ISX-5 (pair)**  
Compact 2-channel trapezoidal speaker  
Price for the pair

Code : B00618 209€ incl. VAT



## Hanging brackets:

SUPS6	Hanging bracket for S6 satellite - black	H9705	36€ incl. VAT
SUPS6w	Hanging bracket for S6 satellite	H9706	36€ incl. VAT
SUPS8	Hanging bracket for S8 satellite - black	H9707	39€ incl. VAT
SUPS8w	Hanging bracket for S8 satellite - white	H9708	39€ incl. VAT
SUPS10	Hanging bracket for S10 satellite - black	H9709	45€ incl. VAT
SUPS10w	Hanging bracket for S10 satellite - white	H9710	45€ incl. VAT

	S6	S8	S10	ISX-10 (UNIT)	ISX-5 (UNIT)
Power	100W RMS / 200W MAX	150W RMS / 300W MAX	250W RMS / 500W MAX	160 W RMS	80 W RMS
Frequency response	80 HZ / 20 KHZ	80 HZ / 19 KHZ	75 HZ / 19 KHZ	100 Hz - 20 Khz	120 Hz - 20 Khz
Sensitivity	93 DB / 118 DB MAX	94 DB / 121 DB MAX	96 DB / 126 DB MAX	116	110
Impedance	8Ω	8Ω	8Ω	8Ω	16Ω
Speakers	6.5"	8"	10"	2X5"	5 INCH
Dispersion HxV	90° / 60°	50-100° / 55°	50-100° / 55°	-	-
Dimensions	222 x 365 x 205 mm	280 x 420 x 233 mm	320 x 530 x 280 mm	400 X 200 X 180 mm	285 X 200 X 180 mm
Weight	6.5 kg	10 kg	14.5 kg	15.5 kg	10.5 kg

# SUBWOOFERS



**NEW**

**ATOM18ASUB**  
18-inch active subwoofers with DSP

Code : H10783      849€ incl. VAT



**NEW**

**ATOM15ASUB**  
15-inch active subwoofers with DSP

Code : H10782      749€ incl. VAT



**SRSUB18A**  
18" active 1200W subwoofer with adjustable filter

Code : H10713      899€ incl. VAT



**SRSUB15A**  
15" active 500W subwoofer with adjustable filter

Code : H10349      749€ incl. VAT



**NEW**

**COV-ATOM18ASUB**  
Protective cover for ATOM18ASUB

Code : H10788      119€ incl. VAT



**NEW**

**COV-ATOM15ASUB**  
Protective cover for ATOM15ASUB

Code : H10787      89€ incl. VAT



**COV-SRSUB18A**  
Protective cover for SRSUB18A subwoofer

Code : H10887      119€ incl. VAT



**COV-SRSUB15A**  
Protective cover for SRSUB15A subwoofer

Code : H10351      89€ incl. VAT

	ATOM18ASUB	ATOM15ASUB	SRSUB18A	SRSUB15A
CODE	H10783	H10782	H10713	H10349
Total power	600 W RMS - 2000 W DYNAMIC	600 W RMS - 2000 W DYNAMIC	600 W RMS - 1200 MAX	
Amplification class	D	D	D	D
Power supply	SMPS switched-mode	SMPS switched-mode	SMPS switched-mode	SMPS switched-mode
Protection	Limiters, thermal and short-circuit	Limiters, thermal and short-circuit	Limiters, thermal and short-circuit	Limiters, thermal and short-circuit
Frequency response	35 Hz to 150 Hz	45 Hz to 160 KHz	60 Hz to 150 KHz	60 Hz to 160 KHz
SPL pressure	127 dB max	126 dB max	127 dB max	125 dB max
Woofer	18" of 4" coil	15" of 4" coil	18" of 4" coil	15" of 4" coil
Pre-amplification	Line Inputs for XLR/Jack Combo	Line Inputs for XLR/Jack Combo	Line Inputs for XLR/Jack Combo	Line Inputs for XLR/Jack Combo
	Line Outputs on XLR	Line Outputs on XLR	Line Outputs on XLR	Line Outputs on XLR
	Volume adjustment	Volume adjustment	Volume adjustment 60 to 150 Hz adjustable filter	Volume adjustment 60 to 150 Hz adjustable filter
DSP	Equalisation presets: Normal, Enforce Position presets: Normal, Cardioid, Endfire Extension from 0 to 15 m Normal or inverted polarity Filtering: 60/80/100/120/150 Hz + high output for ATOM 10A/12A/15A		-	-
Dimensions (H x W x D)	662 x 510 x 615 mm	612 x 430 x 595 mm	770 x 680 x 560 mm	702 x 560 x 472 mm
Net weight	38 kg	30.3 kg	39 kg	34 kg





### NEW

#### ATOM-WHEELS

4-wheel kit for ATOMSUB subwoofer

Code : H10875 59€ incl. VAT



#### iLINEsub12P

12" passive subwoofer- 400W - 8 Ω

Code : H10763 379€ incl. VAT



Power rating: 400 W RMS/800 W max  
Frequency response: 50 Hz - 200 Hz  
Axial sensitivity (1W/1m) : 96 dB  
Max. SPL: 125 dB  
Nominal impedance: 8 Ω  
Speakers: 12 inch  
Dimensions: 350 x 515 x 490 mm  
Net weight: 22 Kg

Connectors:  
- Input: Speakon 4 points output  
- 1+/1- : Broadband output  
- 2+/2- : Bass output:



#### iLINEsub12A

12" active subwoofer 700W + 700W with built-in DSP

Code : H10761 629€ incl. VAT



Power rating: 700W / 4Ω + 700W / 4Ω  
Frequency response: 50 Hz - 200 Hz  
Axial sensitivity (1W/1m) : 96 dB  
Max. SPL: 124 dB  
Nominal impedance: 8 Ω  
Loudspeaker: 12 inch  
Size: 350 x 515 x 490 mm  
Net weight: 23.5 Kg

Amplification:  
- Total available power 700+700 W RMS / 4Ω :  
- Broadband outputs: 700W RMS / 4Ω .  
- Bass outputs: 350W RMS / 8Ω. + 350W RMS / 8Ω internal



#### iLINEbox

USB → RJ45 converter for DSP of iLINEsub12A

Code : H10762 29€ incl. VAT



DSP : 28/56 bit, 50 MIPS  
Setting the system via the supplied software  
Connectors:  
- RJ45  
- USB B  
Dimensions: 56 x 58 x 23 mm  
Weight: 65 g

Delivered with USB A/USB B cord



#### iLINEcov

Protective cover for iLINE series subwoofers

Code : H10768 69€ incl. VAT



#### HL-8ASUB

Subwoofer for active compact line array 2 x 8" - 300W RMS

Code : H10519 899€ incl. VAT



General features  
Power rating: 300W RMS - 600W max  
Frequency response: 80 - 200Hz  
SPL max. (@1m) : 110 dB  
Nominal impedance: 4 Ω  
Woofer: 2 x 8 inches  
Dimensions: 485 x 540 x 260 mm  
Net weight: 19.2 kg

Amplification Class D  
Low level: 2 x 200W RMS / 8 Ω  
Mid/high level 2 x 200W RMS / 8 Ω



#### HL-10ASUB

Subwoofer for active compact line array 2 x 10" - 400W RMS

Code : H10520 999€ incl. VAT



General features  
Power rating: 400W RMS - 800W max  
Frequency response: 50 - 200Hz  
SPL max. (@1m) : 114 dB  
Nominal impedance: 4 Ω  
Woofer: 2 x 10 inches  
Dimensions: 485 x 540 x 310 mm  
Net weight: 29.2 kg

Amplification Class D  
Low level: 2 x 320W RMS / 8 Ω  
Mid/high level 2 x 200W RMS / 8 Ω



#### HL-BUMPER

Suspension frame for hanging the complete line array

Code : H10521 109€ incl. VAT



Can hang a maximum of 8 heads and 2 subwoofers  
Maximum weight supported: 110 kg

# SUBWOOFERS

- Passive subwoofers for high-end performance
- Designed, developed and manufactured in Europe
- FAITAL brand components with Neodymium magnet, high quality Baltic birch plywood and coating of polyurethane "Chemline" (USA) anti-scratch paint
- 2400W AES

**SQ-218**  
2x 18" 2400W aes subwoofers

---

Code : B09189      1 999€ incl. VAT

---





**SQ-215**  
2x 15" 2400W aes subwoofers

---

Code : B09188      1 499€ incl. VAT

---





**SQ-212**  
2x 12" 2400W aes subwoofers

---

Code : B09187      1 199€ incl. VAT

---



	<b>SQ-218</b>	<b>SQ-215</b>	<b>SQ-212</b>
CODE	B09189	B09188	B09187
Total power	2400 W AES	2400 W AES	2400 W AES
Impedance	4 Ω	4 Ω	4 Ω
Bass frequency limit	25 Hz	30 Hz	35 Hz
SPL pressure	102 dB 1W/1m - 146 dB max	101 dB 1W/1m - 145 dB max	101 dB 1W/1m - 135 dB max
Woofer	2x18" Faital	2x15" Faital	2x12" Faital
Dimensions (H x W x D)	1180 x 800 x 560 mm	800 x 800 x 540 mm	600 x 600 x 400 mm
Net weight	80 kg	60 kg	38.2 kg

More information on: [www.synq-audio.com](http://www.synq-audio.com)



### MTSub12A

400W amplified subwoofer - Bass reflex

Code : H10078

529€ incl. VAT



Total power of amp: 400 W RMS / 800 W Max :  
 SMPS switched mode power supply  
 Frequency response: 50 Hz to 180 Hz  
 SPL acoustic pressure: 124 dB max  
 Woofer : 12", 4 Ω, 400 W RMS  
 1 stereo line input on XLR and RCA  
 1 stereo line output on XLR  
 Volume adjustment  
 Adjusting the low cut-off frequency of the sub: from 80 to 180 Hz  
 Low cut filter [OFF-80-125] for satellite output  
 Phase correction 0-180  
 Protections: CC, thermal and limiter  
 Dimensions: 469 x 489 x 360 mm  
 Net weight: 21.6 kg



### CPX-1510SUB

15" active subwoofer with 2x100W active output

Code : B00612

429€ incl. VAT



Power rating: 300 + 200 RMS  
 Frequency response: 35 - 20000Hz  
 SPL max. (@1m) : 128 dB  
 Woofer: 15 inch  
 Dimensions: 440 x 600 x 590 mm  
 Net weight: 42.8 kg

Amplification  
 Low level: 1x 300W RMS  
 Mid/high level: 2x 100W RMS  
 Adjustments: Satellite volume + subwoofer volume



### RS-218B

Subwoofer equipped with two 18" high power and compact speakers.

Code : B00636

949€ incl. VAT



Nominal RMS power: 2x 600W  
 Nominal PEAK power: 2x 1200W  
 Nominal impedance: 2x 8Ω  
 Parallel mode:  
 Nominal RMS power: 1x 1200W  
 Nominal PEAK power: 1x 2400W  
 Nominal impedance: 1x 4Ω  
 Frequency response: 35 - 300Hz  
 Sensitivity (1W/1m): 104dB  
 Max. SPL: 138dB  
 Dimensions (WxDxH):  
 1200 x 700 x 565 mm  
 Weight (net): 84 kg



### Ex15S

15" 600W passive subwoofer

Code : H9701

569€ incl. VAT



Power: 600 W RMS / 1200 W peak  
 Frequency response [-3 dB] :  
 50 Hz - 200 Hz  
 Impedance: 8 Ω  
 Sensitivity 1 W/1 m : 99 dB / 132 dB SPL  
 Woofer : 15" aluminium frame with 100 mm coil  
 Connectors: Speakon x 2 (1+1- full range)  
 Dimensions (H x W x D) :  
 450 x 560 x 635  
 Net weight: 31 kg



### VIBE18-SUB Mk2

Pro subwoofer: 18" - 600Wrms / 8Ω

Code : B00695

469€ incl. VAT



Power rating: 600W RMS  
 Frequency response: 30Hz -250 Hz  
 SPL max. (@1m) : 131 dB  
 Nominal impedance: 8 Ω  
 Woofer: 18" aluminium  
 Connectors: 2 speakon  
 Dimensions: 590 x 736 x 756 mm  
 Net weight: 57 kg



### VIBE15-SUB Mk2

Pro subwoofer: 15" - 400Wrms / 8Ω

Code : B00694

349€ incl. VAT



Power rating: 400W RMS  
 Frequency response: 40Hz -300 Hz  
 SPL max. (@1m) : 124 dB  
 Nominal impedance: 8 Ω  
 Woofer: 15" aluminium  
 Connectors: 2 speakon  
 Dimensions: 440 x 595 x 605 mm  
 Net weight: 32.5 kg

# SUBWOOFERS



**TOURING BAG -  
Vibe 15 SUB**  
Travel bag for Vibe 15 SUB

Code : B00594 49,90€ incl. VAT



High-performance protective cover for Series Vibe models.



**TOURING BAG -  
Vibe 18 SUB**  
Travel bag for Vibe 18 SUB

Code : B00595 79€ incl. VAT



High-performance protective cover for Series Vibe models.



**ISX-15S**  
Subwoofer 15": 2x350Wrms / 2x 4 Ω

Code : B00620 369€ incl. VAT



Power rating: 2x 350W RMS  
Frequency response: 45Hz -250Hz  
Built-in 2-channel 150Hz filter  
SPL max. (l@1m) : 124 dB  
Nominal impedance: 2x4 Ω  
Woofer: 2x15" double coil  
Connectors: 2 x input and output terminal block  
Dimensions: 340 x 680 x 470 mm  
Net weight: 30.4 kg



**CUBsub112**  
12" 300W passive subwoofer

Code : H10664 249€ incl. VAT



Power rating: 300W RMS - 600W max  
Frequency response: 45Hz -2.8KHz  
Filter: the subwoofer is not equipped with a passive filter  
SPL max. (l@1m) : 125 dB  
Nominal impedance: 8 Ω  
Woofer: 12" to 64 mm coil  
Connectors: 2 speakon and terminal block for In/Out  
Dimensions: 350 x 500 x 540 mm  
Net weight: 20 kg



**CUBsub208**  
Passive subwoofer to 2 HP from 8" 300W RMS

Code : H10665 279€ incl. VAT



Power rating: 300W RMS - 600W max  
Frequency response: 50Hz -800Hz  
Filter: The subwoofer is not equipped with a passive filter  
SPL max. (l@1m) : 124 dB  
Nominal impedance: 4 Ω  
Woofer: 2 x 8" to 50 mm coil  
Connectors: 2 x speakon and terminal block for In/Out  
Dimensions: 250 x 510 x 540 mm  
Net weight: 18.5 kg



**CB-210**  
Subwoofer 2 x 10" - 300W

Code : H9256 369€ incl. VAT



Power handling: 300 W RMS / 600 W max.  
Frequency response (+/-3 dB) : 48 - 160 Hz  
Sensitivity (1 W/1 m) : 96 dB  
Max. SPL: 127 dB  
Loudspeaker: 2 x 26 cm - 50 mm coil  
Nominal impedance: 4 Ω  
Connectors: 2 x Speakon NL4  
1 base for coupling bar  
Dimensions (H x W x D) : 400 x 650 x 445 mm  
Weight: 32 kg



**I-SUB 210**  
SYNQ high power subwoofer 2 x 10" with very compact design.

Code : B00642 319€ incl. VAT



Power rating: 500 W RMS  
Frequency response: 50Hz -200Hz  
SPL 1w/1m : 98 dB  
Nominal impedance: 8 Ω  
Woofer: 2x10"  
Connectors: 2 x speakon  
Dimensions: 600 x 350 x 410 mm  
Net weight: 26 kg



### SQ-212 DOLLY

Customised SYNQ trolley for fast and safe SQ subwoofer transport

Code : B09190

259€ incl. VAT



### SQ-215 DOLLY

Customised SYNQ trolley for fast and safe SQ subwoofer transport

Code : B09191

319€ incl. VAT



### SQ-218 DOLLY

Customised SYNQ trolley for fast and safe SQ subwoofer transport

Code : B09192

369€ incl. VAT



### WHEELSET

SYNQ set of wheels for subwoofer Synq (RS and CLS series)

Code : B00637

44,90€ incl. VAT



Custom trolley for fast and safe transportation of SQ subwoofers. Thanks to a special robust mechanism, the trolley adapts easily to the front of the subwoofer to protect it.

Set of wheels for the subwoofers Synq (RS and CLS series)



# AMPLIFIERS

The heart of playback, performance and durability, exceptional sound quality. Professional and consumer solutions.



### DSPA-1500

2 x 440W @ 8Ω, 2 x 750W @ 4Ω,  
2 x 1200W @ 2Ω

Code : B00275

519€ incl. VAT



### DSPA-1000

2 x 300W @ 8Ω, 2 x 500W @ 4Ω,  
2 x 750W @ 2Ω

Code : B00274

419€ incl. VAT



### SMi1500

Amplifier with switched-mode power  
supply 2 x 750W @ 4Ω

Code : H9829

499€ incl. VAT



### SMi1000

Amplifier with switched-mode power  
supply 2 x 500W @ 4Ω

Code : H9828

369€ incl. VAT



### SMi600

Amplifier with switched-mode power  
supply 2 x 300W @ 4Ω

Code : H9827

309€ incl. VAT



### C3-1800

2x 450Wrms + 900Wrms subwoofer @ 4Ω

Code : B00262

709€ incl. VAT



	DSPA-1500	DSPA-1000	SMi1500	SMi1000	SMi600	C3-1800
Power	<ul style="list-style-type: none"> <li>- RMS stereo</li> <li>4Ω: 2 x 750W</li> <li>4Ω: 2 x 440 W</li> <li>2 Ω : 2 x 1200 W</li> </ul> <ul style="list-style-type: none"> <li>- Bridged mono</li> <li>8 Ω : 1 x 1500 W</li> <li>4Ω: 1 x 2400 W</li> </ul>	<ul style="list-style-type: none"> <li>- RMS stereo</li> <li>4Ω: 2 x 500 W</li> <li>8 Ω : 2 x 300 W</li> <li>2 Ω : 2 x 750W</li> </ul> <ul style="list-style-type: none"> <li>- Bridged mono</li> <li>8 Ω : 1 x 1000 W</li> <li>4Ω: 1 x 1500 W</li> </ul>	<ul style="list-style-type: none"> <li>- RMS stereo</li> <li>4Ω: 2 x 750W</li> <li>8 Ω : 2 x 450 W</li> <li>2 Ω : 2 x 1000 W</li> </ul> <ul style="list-style-type: none"> <li>- Bridged mono</li> <li>8 Ω : 1 x 1500 W</li> <li>4Ω: 1 x 2000 W</li> </ul>	<ul style="list-style-type: none"> <li>- RMS stereo</li> <li>4Ω: 2 x 500W</li> <li>8 Ω : 2 x 310 W</li> <li>2 Ω : 2 x 600 W</li> </ul> <ul style="list-style-type: none"> <li>- Bridged mono</li> <li>8 Ω : 1 x 1000 W</li> <li>4Ω: 1 x 1200 W</li> </ul>	<ul style="list-style-type: none"> <li>- RMS stereo</li> <li>4Ω: 2 x 300 W</li> <li>8 Ω : 2 x 200 W</li> <li>2 Ω : 2 x 450 W</li> </ul> <ul style="list-style-type: none"> <li>- Bridged mono</li> <li>8 Ω : 1 x 600 W</li> <li>4Ω: 1 x 900 W</li> </ul>	<ul style="list-style-type: none"> <li>- RMS stereo</li> <li>4Ω: 2 x 450W RMS</li> <li>8 Ω : 2 x 300 W RMS</li> </ul> <ul style="list-style-type: none"> <li>Subwoofer:</li> <li>4Ω: 1 x 900 W RMS</li> <li>8 Ω : 1 x 600 W RMS</li> </ul>
Type of amplification	Class D	Class D	Class 2H	Class AB	Class AB	Class AB
Damping factor	200	200	200	200	100	500
Cooling	Front-to-back regulated ventilation					
Connectors	<ul style="list-style-type: none"> <li>- Input: Balanced combo (XLR + TRS jack) connector</li> <li>- Output: Screw-on terminals + 4-pole Speakon®</li> </ul>		<ul style="list-style-type: none"> <li>- Input: XLR + Jack + RCA connectors</li> <li>- Output: Screw-on terminals + 4-pole Speakon®</li> </ul>		<ul style="list-style-type: none"> <li>- Input: XLR connectors</li> <li>- Output: 4-Pole Speakon®</li> </ul>	
Protections	<ul style="list-style-type: none"> <li>- Against short-circuits</li> <li>- Signal and current limiter</li> <li>- Against voltage deviations</li> <li>- Thermal protection</li> </ul>		<ul style="list-style-type: none"> <li>- Against short-circuits</li> <li>- Current limiter</li> <li>- Against voltage deviations</li> <li>- Immunity to radio frequencies</li> <li>- Thermal protection and regulation</li> </ul>		<ul style="list-style-type: none"> <li>- Limiter</li> <li>- Against short-circuits</li> <li>- Against overloads and DC</li> <li>- Thermal protection and regulation</li> </ul>	
DSP	HPF, LPF, PEQ, Q, Limiter, Delays, filters.					
Dimensions (L x W x H)	19" x 2U (482 x 88 x 280mm)		19" x 2 U: 483 x 89 x 395mm		19" x 2 U: 483 x 89 x 473 mm	
Weight	5.2kg	4.9 kg	9.2 kg	6.9 kg	6 kg	24 kg



**DIGIT 3K6**  
2 x 1,800Wrms / 4Ω, class D

Code : B00267      689€ incl. VAT

**DIGIT 2K2**  
2 x 1,100Wrms / 4Ω, class D

Code : B00266      599€ incl. VAT

**DIGIT 1K0**  
2 x 540Wrms / 4Ω, class D

Code : B00268      309€ incl. VAT

	DIGIT 3K6	DIGIT 2K2	DIGIT 1K0
Power	<ul style="list-style-type: none"> <li>- RMS stereo 4Ω : 2 x 1800 W 8 Ω : 2 x 1050 W</li> <li>- Bridged mono 8 Ω : 1 x 3600W</li> </ul>	<ul style="list-style-type: none"> <li>- RMS stereo 4Ω : 2 x 1100 W 8 Ω : 2 x 650 W</li> <li>- Bridged mono 8 Ω : 1 x 2200W</li> </ul>	<ul style="list-style-type: none"> <li>- RMS stereo 4Ω : 2 x 540 W 8 Ω : 2 x 300 W</li> <li>- Bridged mono 8 Ω : 1 x 1080W</li> </ul>
Type of amplification	Class D	Class D	Class D
Damping factor	300	300	280
Cooling	Front-to-back regulated ventilation		
Connectors	<ul style="list-style-type: none"> <li>- Input: XLR/Jack combo connectors</li> <li>- Output: 4-Pole Speakon®</li> </ul>		
Protections	<ul style="list-style-type: none"> <li>- Against short-circuits</li> <li>- Signal + current limiter</li> <li>- Against overloads</li> <li>- Thermal protection</li> <li>- AC, VHF protection</li> </ul>		
Dimensions [L x W x H]	19" x 1 U: 483 x 44 x 301 mm		19" x 1 U: 483 x 44 x 301 mm
Weight	5.6 kg	5.5 kg	3.3 kg

# AMPLIFIERS

			
<b>AMP 400.2</b> 2 x 400Wrms / 4Ω	<b>AMP 200.2</b> 2 x 200Wrms / 4Ω	<b>AMP 100.2</b> 2 x 100Wrms / 4Ω	<b>AMP 150.4</b> 4 x 150W @ 4Ω
Code : B00272      359€ incl. VAT	Code : B00271      229€ incl. VAT	Code : B00270      209€ incl. VAT	Code : B00273      359€ incl. VAT
			

		
<b>Ti500</b> Class D Amplifier 1 unit 2 x 250W @ 4Ω or 1 x 500W @ 8Ω	<b>Ti300</b> Class D Amplifier 1 unit 2 x 150W @ 4Ω or 1 x 300W @ 8Ω	<b>Ti154</b> Class D Amplifier 1 unit 4 x 150W @ 4Ω or 2 x 300W @ 8Ω
Code : H9673      289€ incl. VAT	Code : H9672      229€ incl. VAT	Code : H10412      359€ incl. VAT
		

	AMP 400.2	AMP 200.2	AMP 100.2	AMP 150.4	Ti500	Ti300	Ti154
Power	- RMS stereo 4Ω: 2 x 400 W 8 Ω : 2 x 250 W  - Bridged mono 8 Ω : 1 x 800W	- RMS stereo 4Ω: 2 x 200 W 8 Ω : 2 x 130 W  - Bridged mono 8 Ω : 1 x 400W	- RMS stereo 4Ω: 2 x 100 W 8 Ω : 2 x 70 W  - Bridged mono 8 Ω : 1 x 200W	4Ω: 4 x 150 W RMS 8 Ω : 4 x 80 W RMS	- RMS stereo 4Ω: 2 x 250 W 8 Ω : 2 x 130 W  - Bridged mono 8 Ω : 1 x 500W	- RMS stereo 4Ω: 2 x 150 W 8 Ω : 2 x 80 W  - Bridged mono 8 Ω : 1 x 300W	4Ω: 4 x 150 W RMS 8 Ω : 4 x 80 W RMS
Type of amplification	Class D						
Cooling	Front-to-back regulated ventilation						
Connectors	- Input: XLR connectors - Output: 4-Pole Speakon®	- Input: XLR+jack connectors  - Output: 4-Pole Speakon®	- Input: XLR/Jack combo connectors - Output: 4-pole Speakon® + terminal blocks				
Protections	- Against short-circuits - Signal + current limiter - Against overloads - Thermal protection						
Dimensions (L x W x H)	19" x 1U 483 x 44 x 310 mm	19 inches x 1U: 483 x 44 x 225 mm	19 inches x 1U: 483 x 44 x 225 mm	19 inches x 1U: 483 x 44 x 330 mm	19 inches x 1U: 483 x 44 x 330 mm	19 inches x 1U: 483 x 44 x 330 mm	19 inches x 1U: 483 x 44 x 330 mm
Weight	5.8 kg	3.7 kg	3.7 kg	5.2kg	4.7 kg	4.3 kg	4.5 kg





			
<b>PE-2400</b> 2 x 1,200Wrms / 4Ω, class H <hr/> Code : B00265      729€ incl. VAT	<b>PE-900</b> 2 x 450Wrms / 4Ω, class H <hr/> Code : B00263      489€ incl. VAT	<b>Wi1800</b> 2 x 900W RMS amplifier @ 4Ω 2 x 600W @ 8Ω - Bridgeable @ 4Ω <hr/> Code : H9565      649€ incl. VAT	<b>Wi1500</b> 2 x 750W RMS amplifier @ 4Ω 2 x 500W @ 8Ω - Bridgeable @ 4Ω <hr/> Code : H9564      599€ incl. VAT
			
			
<b>Wi1200</b> 2 x 600W RMS amplifier @ 4Ω 2 x 400W @ 8Ω - Bridgeable @ 4Ω <hr/> Code : H9563      529€ incl. VAT	<b>Wi900</b> 2 x 450W RMS amplifier @ 4Ω 2 x 300W @ 8Ω - Bridgeable @ 4Ω <hr/> Code : H9562      449€ incl. VAT	<b>Wi640</b> 2 x 320W RMS amplifier @ 4Ω 2 x 210W @ 8Ω - Bridgeable @ 4Ω <hr/> Code : H9561      349€ incl. VAT	<b>WA-4X3</b> 4 channel amplifier 4 x 300W RMS @ 4Ω <hr/> Code : H9066      699€ incl. VAT
			

	PE-2400	PE-900	Wi1800	Wi1500	Wi1200	WA-4X3
Power	- RMS stereo 4Ω: 2 x 1200 W 8 Ω : 2 x 800 W 2 Ω : 2 x 1440 W  - Bridged mono 8 Ω : 1 x 2,400W 4Ω: 1 x 2800 W	- RMS stereo 4Ω: 2 x 450 W 8 Ω : 2 x 800 W 2 Ω : 2 x 1440 W  - Bridged mono 8 Ω : 1 x 2,400W 4Ω: 1 x 2800 W	- RMS stereo 4Ω: 2 x 900 W 8 Ω : 2 x 600 W 2 Ω : 2 x 1400 W  - Bridged mono 8 Ω : 1 x 1800 W 4Ω: 1 x 2800 W	- RMS stereo 4Ω: 2 x 750W 8 Ω : 2 x 500 W 2 Ω : 2 x 1200 W  - Bridged mono 8 Ω : 1 x 1400 W 4Ω: 1 x 2400 W	- RMS stereo 4Ω: 2 x 600 W 8 Ω : 2 x 400 W 2 Ω : 2 x 900 W  - Bridged mono 8 Ω : 1 x 1200 W 4Ω: 1 x 1800 W	- RMS stereo 4Ω: 4 x 300 W 8 Ω : 4 x 200 W  - Bridged stereo 8 Ω : 2 x 600 W - 2.1 stereo 8 Ω : 2 x 200 W + 1 x 600W bridged
Type of amplification	Class H	Class H	Class H	Class H	Class AB	Class AB
Damping factor	450	450	350	350	250	200
Cooling	Front-to-back regulated ventilation					
Connectors	- Input: XLR/Jack combo connectors - Output: 4-Pole Speakon®	- Input: XLR/Jack combo connectors - Output: Screw-on terminals + 4-pole Speakon®			- Input: XLR + jack + RCA connectors - Output: Screw-on terminals + 4-pole Speakon®	
Protections	- Against short-circuits and overloads - Automatic current limiter - Against DC current - High-temperature protection		- Against short-circuits - Current limiter - Against voltage deviations - Immunity to radio frequencies - Thermal protection and regulation			
Dimensions [L x W x H]	19" x 2 U: 483 x 89 x 440 mm		19" x 2 U: 483 x 89 x 420 mm			19" x 2 U: 483 x 89 x 375 mm
Weight	25 kg	25 kg	21.2 kg	19.5 kg	19.2 kg	16 kg

# AMPLIFIERS



## VX700 II

Professional amplifier 2 x 350Wrms / 4Ω.

Code : B00295 314,90€ incl. VAT



## VX400 II

Professional amplifier 2 x 200Wrms / 4Ω.

Code : B00294 229€ incl. VAT



## VX200 II

Professional amplifier 2 x 110Wrms / 4Ω.

Code : B00293 219€ incl. VAT



## AS-620

2 x 300W RMS amplifier

Code : H7593 229€ incl. VAT



## AS-420

2 x 200W RMS amplifier

Code : H7578 179€ incl. VAT



## AS-220

2 x 120W RMS amplifier

Code : H7577 159€ incl. VAT



	VX700 II	VX400 II	VX200 II	AS-620	AS-420	AS-220
Power	- RMS stereo 4Ω: 2 x 350 W 8 Ω : 2 x 200 W  - Bridged mono 8 Ω : 1 x 700 W	- RMS stereo 4Ω: 2 x 200 W 8 Ω : 2 x 135 W	- RMS stereo 4Ω: 2 x 110 W 8 Ω : 2 x 65 W  - Bridged mono 8 Ω : 1 x 220 W	- RMS stereo 4Ω: 2 x 300 W 8 Ω : 2 x 220 W	- RMS stereo 4Ω: 2 x 200 W 8 Ω : 2 x 100 W	- RMS stereo 4Ω: 2 x 120 W 8 Ω : 2 x 75 W
Type of amplification	Class D	Class D	Class D	Class D	Class D	Class D
Damping factor	200	150	150			
Cooling	Front-to-back regulated ventilation					
Connectors	- Input: XLR + jack connectors - Output: Screw-on terminals + 4-pole Speakon®			- Input: Jack connectors - Output: Speakon®		
Protections	- Against short-circuits - Current limiter - Thermal protection and regulation			- Against short-circuits - Against overloads - Thermal protection		
Dimensions (L x W x H)	19" x 2 U: 483 x 89 x 260 mm		19" x 1U 483 x 44 x 320 mm			19" x 2 U: 483 x 89 x 210 mm
Weight	13 kg	9 kg	9.5 kg	14 kg	10 kg	8 kg



**AVM-3**  
Class D amplifier module for VIBE18-SUB Mk2.

---

Code : B00242      329€ incl. VAT

---



**AVM-2**  
Class D amplifier module for VIBE15 Mk2, VIBE30 Mk2 and VIBE15-SUB Mk2.

---

Code : B00241      319€ incl. VAT

---



**AVM-1**  
Class D amplifier module for VIBE8 Mk2, VIBE10 Mk2 & VIBE12 Mk2

---

Code : B00240      219€ incl. VAT

---



	AVM-3	AVM-2	AVM-1
Power	4Ω: 1200W RMS 8 Ω : 800 W RMS	4Ω: 800 W RMS 8 Ω : 500 W RMS	4Ω: 500 W RMS 8 Ω : 300 W RMS
Type of amplification	Class D		
Damping factor	500		
Cooling	Regulated ventilation		
Connectors	- Input: XLR+jack+RCA connectors - Output: Speakon® 1+/1-		
Protections	- Against short-circuits - Signal + current limiter - Against overloads - Thermal protection		
Dimensions (L x W x H)	320 x 160 x 87 mm	320 x 160 x 87 mm	275 x 145 x 72 mm
Weight	3.4 kg	3.4 kg	2 kg

More information on: [www.jb-systems.eu](http://www.jb-systems.eu)

# SOUND PROCESSING

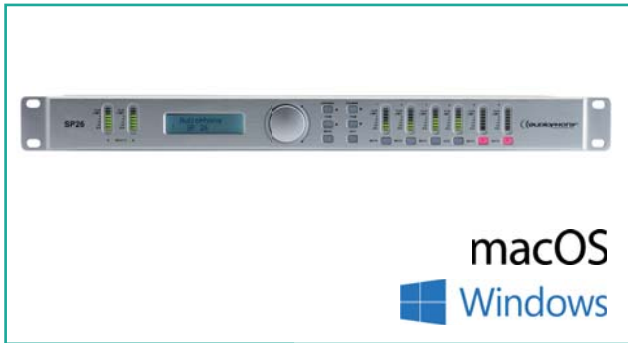

## SP26

2IN6OUT sound processor with software

Code : H10712

469€ incl. VAT



Inputs: 2 balanced inputs  
Outputs: 6 balanced outputs  
Sampling rate: 96kHz, 24-bit depth  
Crossover / EQ Operational frequency range: 20Hz – 20kHz  
Crossover filtering: Bessel, Butterworth (6, 12, 24 and 48dB/octave), Linkwitz-Riley (12 and 24dB/octave)  
10-band equaliser: Bell, Notch, All Pass, Band Pass, Low/High Pass, Low/High Shelf  
Equaliser gain : adjustable from -12dB to +12dB  
Equaliser Q: Adjustable from 0.2 to 25  
Phase inversion  
Limiter attack time from 10 to 100  
Limiter threshold from -48dB to 9dB  
Password protection  
50 presets available  
Dimensions (mm): 483 x 127 x 45 (1U)  
Weight: 3kg



## Q215

2x15-band equaliser +/- 12dB - 1U

Code : H9670

139€ incl. VAT



Stereo equaliser, 2/3 octaves from 31.5Hz to 16kHz  
Adjustable output level: +12/-12 dB  
20mm faders  
Low-cut filter per channel (60Hz -3dB)  
Balanced inputs: XLR, 6.35 TRS jack  
Unbalanced inputs: RCA  
Balanced outputs: XLR, 6.35 TRS jack  
Unbalanced outputs: RCA  
Recording output (REC OUT) on unbalanced RCA (output level -6 dB)  
Signal level indicator: -10dB, 0dB, +10dB, +17dB  
Low-cut and bypass indicator  
Dimensions: 483 x 44 x 190 mm  
Weight: 2.4kg



## BEQ-15

2x15-band stereo equaliser.

Code : B00288

114,90€ incl. VAT



2 x 15-band stereo equaliser 2/3 octaves from 25Hz to 16kHz  
Adjustable output level: +/-6dB or +/- 12dB  
20mm faders  
Balanced inputs: XLR, 6.35 TRS jack  
Unbalanced inputs: RCA  
Balanced outputs: XLR, 6.35 TRS jack  
Unbalanced outputs: RCA  
Level switch: 6dB/12dB  
Equaliser bypass switch  
Subsonic filter switch  
< 20Hz  
Dimensions: 483 x 44 x 165 mm  
Weight: 2.5 Kg



## X312

2-way stereo or 3-way mono active filter

Code : H9669

139€ incl. VAT



Inputs / outputs on balanced XLR + 4dB  
Stereo (2-way + subwoofer) or mono (3-way + subwoofer) operation  
LOW SUM mode to sum low frequencies from both inputs and output to mono  
Lows, mids and highs phase reversal possible  
In stereo mode:  
- Adjustment of cut-off frequency between highs and lows for each side (45 to 960Hz)  
In mono mode:  
- Adjustment of cut-off frequency between highs, mids and lows (45 to 960Hz and 450 to 9,600Hz)  
- Optional use of SUB output with adjustable level and cut-off frequency (20 to 200Hz)  
Dimensions: 483 x 175 x 44mm  
Weight: 2kg



## XO 2.4

Active filter: 2-way stereo or 3-way mono.

Code : B00287

109€ incl. VAT



Balanced XLR inputs and outputs  
Stereo or mono operation  
Phase reversal switch  
40Hz subsonic filter (with on/off switch)  
In stereo mode:  
- Adjustment of cut-off frequency between highs and lows for each side (45 to 960Hz)  
In mono mode:  
- Adjustment of cut-off frequency between highs, mids and lows (45 to 960Hz and 450 to 9,600Hz)  
Dimensions: 483 x 136 x 44mm  
Weight: 2kg



## ENH 2.3

Professional multi-band sound enhancer

Code : B00286

115€ incl. VAT



Adds harmonics to sound, increasing definition, presence and transparency. Considerably enhances low frequencies (more punch)  
Balanced XLR inputs and outputs  
Separate subwoofer output with adjustable output level and cut-off frequency from 100 to 250Hz.  
Low Mix adjustment for lows HPF from 1 to 8kHz for cut-off frequency  
High Mix adjustment for high-mids  
Phase reversal switch  
CLIP indicator  
Level indicator -40/-20/-6/-2dB  
Dimensions: 483 x 154 x 44mm  
Weight: 1 kg



### SDI-1

Stereo DI-box. Converts unbalanced audio signals into balanced signals

Code : B00279 59€ incl. VAT



This stereo DI-box is the perfect solution for various applications!  
It allows conversion of unbalanced audio signals into balanced signals for transport through long cables.  
The "ground lift" switch allows separation of the inputs/outputs to avoid ground loops.  
Solid anodised aluminium black housing  
1 RCA and XLR/6.35 jack combo input  
1 XLR output  
Max. input level: +21dBu  
Dimensions: 105 x 110 x 44 mm  
Weight: 0.440 Kg



### BDA-100

Active direct box

Code : H7678 55€ incl. VAT



1 unbalanced 6.35 jack input  
1 balanced XLR input  
1 XLR output  
Max. input level: 0/+20/+40dB  
Dimensions: 135 x 55 x 130 mm  
Weight: 0.700 Kg  
9V battery not included



### AD-BOX

Analogue/digital converter  
USB - Unbalanced 1IN/1OUT

Code : H9268 59€ incl. VAT



Works on PC or Mac without specific drivers  
16-bit/48KHz AD-DA converter  
1 input / 1 output  
Combo connector input  
RCA connector output  
Powered by USB port



### CONVERTER

USB/LINE converter and PHONO with Soft

Code : H9077 39€ incl. VAT



Provided with Audacity, the French audio processing software  
Comprehensive and efficient tools to optimise the quality of your recording  
Simple user interface, allowing to record vinyl records at high speed.  
Plug-and-play and driverless operation with most audio software on the market.  
2 RCA inputs (L and R), line/phono switch  
- 2 RCA outputs (L and R), line level  
Cable length: 1.5m



### BT10ER

Bluetooth transmitter-receiver

Code : H10015 59€ incl. VAT



Bluetooth® : 3.0  
Supported Bluetooth®profiles: apt-X, A2DP and AVRCP  
Apt-x® decoder Low Latency 32ms  
Operating distance:  
10 metres on average - Class 2  
Battery life 9 to 10 hours on average  
Battery: Lithium-polymer 270mAh  
Weight: 48.5g  
Dimensions: 50 x 37 x 13 mm



### BT2xE

Double stereo audio

Bluetooth®transmitter

Code : H10413 59€ incl. VAT



Bluetooth® 4.1  
Bluetooth®profile: A2DP  
Audio codecs: aptX-L, aptX, SBS, FastStream  
Operating range: Class 2, 10 meters  
Allows for concurrently pairing two devices  
Operating battery life:  
Up to 8 hours  
Battery: Rechargeable, Li-Po, 250mAh  
Weight: Housing: 23g / Base: 7g  
Dimensions: 48 x 48 x 15 mm



### BT-20R

Bluetooth® receiver HD  
3.5 jack output + USB charger

Code : H10305 39€ incl. VAT



Bluetooth® 4.2  
Supported Bluetooth®profiles: apt-X, A2DP and AVRCP  
Apt-x® decoder Low Latency 32ms  
Operating distance:  
10 metres on average - Class 2  
Power supply: AC100-240V 50/60Hz  
USB output current: 5V / 1A / 5W  
3.5mm jack and RCA cable included

# MIXERS

A mix of genres. This range of mixers offers a solution for each use: Ultra-compact mixers for DJs, multiple-input and output consoles, and live consoles with perfectly transparent preamps for optimal playback for optimal sound quality.



**SMP 16.42**  
16-channel PA mixer with very low background noise architecture

Code : B00152      519€ incl. VAT



16-channel mixer with 4 sub-groups and 2 standalone sub-masters .  
DSP 24-bit effects processor with 100 presets  
Digital audio input/output through USB type B

**Inputs:**  
12 channels with balanced inputs, 8 mono 4 stereo:  
Input gain  
Mono channel inserts  
Peak indicator @ -5dB  
High-pass filter @ 75Hz  
3-band equaliser with parametric adjustment for mids  
1 AUX send pre (monitoring)  
1 AUX send with pre/post switch  
EFX send for effects selection (post)  
PAN / BAL control  
Mute button for each channel  
PFL inverter  
LEVEL with 60mm control fader  
G/D selection and sub-groups 1-2 3-4  
48-volt phantom power

**Outputs:**  
G/D general control, sub-groups, headphones and control room

Footswitch with 6.35 stereo jack (DSP activation)  
2 x 10 sections LED VU-meters  
7-band equaliser for master mix  
19-inch rack brackets included  
Power supply: External  
Net weight: 7.3 Kg  
Dimensions: 436 x 90 x 420 mm



**SMP 12.22**  
12-channel PA mixer with very low background noise architecture.

Code : B00151      349€ incl. VAT



12-channel mixer with 2 sub groups and 2 ALT 3-4 outputs  
DSP 24-bit effects processor with 100 presets  
Digital audio input/output through USB type B

**Inputs:**  
8 balanced input channels, 4 mono 4 stereo:  
Input gain  
Mono channel inserts  
Peak indicator @ -5dB  
High-pass filter @ 75Hz  
3-band equaliser (12kHz/2.5kHz/80Hz)  
AUX send with pre/post switch  
EFX send for effects selection (post)  
PAN / BAL control  
Mute button for channels ALT 3-4  
LEVEL with 60mm control fader  
48-volt phantom power

**Outputs:**  
G/D general control, headphones and control room

Footswitch with 6.35 stereo jack (DSP activation)  
2 x 10 sections LED VU-meters  
19-inch rack brackets included  
Power supply: External  
Net weight: 6.4 Kg  
Dimensions: 328 x 90 x 420 mm



**SMP 8.2**  
8-channel PA mixer with very low background noise architecture.

Code : B00150      239€ incl. VAT



8-channel mixer  
DSP 24-bit effects processor with 100 presets  
Digital audio input/output through USB type B

**Inputs:**  
4 balanced mic input channels, 2 line mono 3 line stereo:  
Input gain  
Mono channel inserts  
Peak indicator @ -5dB  
High-pass filter @ 75Hz  
3-band equaliser  
1 AUX send  
EFX send for effects selection (post)  
PAN / BAL control  
PFL inverter  
Output level adjustment

**Outputs:**  
G/D general control, headphones and control room

Footswitch with 6.35 stereo jack (DSP activation)  
2 x 10 sections LED VU-meters  
Power supply: External  
Net weight: 3.3 Kg  
Dimensions: 249 x 75 x 295 mm



### MX1624

Live Mixer 10 microphones + 2 line + 24-bit DSP 10 FX with USB port

Code : H9560

419€ incl. VAT



8 mono / 4 stereo / 10 mic input mixer  
24-bit DSP effects processor with  
10 presets  
Digital audio input/output through USB  
type B

#### Input adjustments:

Gain / 3-band equaliser / AUX with Pre/  
Post switch/ Effects / Balance / Mute /  
PFL / High-pass filter 75Hz

#### Output adjustments:

Master level / ALT 3/4 / AUX send, AUX  
return and EFX return / Headphones and  
Control Room  
Phantom power  
Effect selector with level adjustment

#### Outputs

Master through 2x XLR and 2x 6.35 stereo  
jacks  
ALT 3/4 through 2x 6.35 stereo jacks  
AUX outputs, Control Room and  
headphones through 6.35 stereo jacks  
Record output through RCA

Footswitch with 6.35 stereo jack (DSP  
activation)

19-inch rack brackets included  
Power supply: External  
Net weight: 5.6 Kg  
Dimensions: 436 x 420 x 65 mm



### MX1224

Live Mixer 6 microphones + 2 line + 24-bit DSP 10 FX with USB port

Code : H9559

329€ incl. VAT



4 mono / 2 mono/stereo and 2-way  
stereo mixer  
24-bit DSP effects processor with  
10 presets  
Digital audio input/output through USB  
type B

#### Input adjustments:

Gain / 3-band equaliser / AUX with Pre/  
Post switch/ Effects / Balance / Mute /  
PFL / High-pass filter 75Hz

#### Output adjustments:

Master level / ALT 3/4 / AUX send, AUX  
return and EFX return / Headphones and  
Control Room  
Phantom power  
Effect selector with level adjustment

#### Outputs:

Master through 2x XLR and 2x 6.35 stereo  
jacks  
ALT 3/4 through 2x 6.35 stereo jacks  
AUX outputs, Control Room and  
headphones through 6.35 stereo jacks  
Record output through RCA

Footswitch with 6.35 stereo jack (DSP  
activation)

2 x 10 sections LED VU-meters  
19-inch rack brackets included  
Power supply: External  
Net weight: 3.4 Kg  
Dimensions: 328 x 420 x 65 mm



### MX822

Live Mixer 4 microphones + 1 line + 24-bit DSP 10 FX with USB port

Code : H9558

219€ incl. VAT



2 mono / 2 mono/stereo and 1-way  
stereo mixer  
24-bit DSP effects processor with  
10 presets  
Digital audio input/output through USB  
type B

#### Input adjustments:

Gain / 3-band equaliser / AUX / Effects /  
Balance / High-pass filter 75Hz

#### Output adjustments:

Master level / AUX return and EFX /  
Headphone  
Phantom power  
Effect selector with level adjustment

#### Outputs:

Master through 6.35 stereo jack  
AUX outputs and headphones through  
6.35 stereo jack  
Record output through RCA

Footswitch with 6.35 stereo jack (DSP  
activation)

2 x 10 sections LED VU-meters  
Power supply: External  
Net weight: 2.8 Kg  
Dimensions: 247 x 290 x 65 mm



# MIXERS



## MIX 5.2

Mixer with 5 channels and 2 independent zones.

Code : B00119

209€ incl. VAT



## MIX6usb

A compact and robust 19" mixer with stylish black design (white and blue LEDs).

Code : B00122

259€ incl. VAT



## SMI-84

An ideal mixer for any pub, bar, hotel, restaurant, etc.

Code : B00123

419€ incl. VAT



## MYA8C

4-channel console + 3 mic + 2 USB

Code : H9880

329€ incl. VAT



### Inputs

1 microphone with Talkover on front panel  
5 microphones on back  
4 line  
2 phono

### Adjustments

3-band equaliser on each output  
3-band equaliser on microphone channel 1  
Gain adjustment for each channel  
Talkover level adjustment  
Choice of zone A or B per channel

### Outputs

Master A balanced and unbalanced  
Master B balanced and unbalanced  
Separate records A and B

LED VU-meters with 10 sections  
Power supply: AC 230V ~ 50Hz  
Dimensions: 483 x 134 x 130 mm  
Weight: 2 Kg

### Inputs

1 USB port on channel 1 for playing and recording audio files  
2 microphones with Talkover  
5 lines,  
2 phono or 2 line,  
1 USB  
Aux on front panel

### Adjustments

3-band equaliser on each channel  
Gain adjustment for each channel  
Talkover level adjustment

### Outputs

Balanced Master  
Separate Booth and Record  
1 USB port

LED VU-meters with 10 sections  
Power supply: AC 230V ~ 50Hz  
Dimensions: 483 x 179 x 104 mm  
Weight: 5.1 Kg

### Mixing console with 4 zones

- 2 USB ports  
- 6 lines through RCA  
- 2 phono  
- 2 microphones with Talkover  
- 1 Aux on front panel

### Level adjustment on front panel

Microphone equaliser on front panel  
Output equaliser on back

### Outputs

Zone A, B, C through XLR mono  
Stereo Master through XLR and RCA  
All outputs are also Euroblock connectors  
Mute key on Euroblock  
Priority input on Euroblock  
2 USB ports allowing playback and recording via a computer

Power supply: AC 230V ~ 50Hz  
Dimensions: 483 x 134 x 184 mm  
Weight: 4.2 Kg

### Inputs

- 1 USB port on channel 6 allowing playback and recording through a computer  
- 2 phono through RCA  
- 7 lines through RCA  
- 2 microphones through combo connector on front panel  
- 1 microphone through jack connector on back  
- 1 mini-jack auxiliary input on front panel

### Adjustments

- 3-band equaliser on stereo channels  
- 3-band equaliser on microphone channels  
- Gain adjustment for each channel

### Outputs

- Master A balanced and unbalanced output  
- Master B unbalanced output  
- Record output  
- Pre-listen output on 6.35 stereo jack  
- 1 USB audio port to connect to a computer

LED VU-meter for Master output and on each phono/line-level channel  
Talkover on all microphone channels  
Power supply: AC 230V ~ 50Hz  
Dimensions: 483 x 264 x 104mm (85mm-deep flush-mounting)  
Weight: 4.5 Kg







### MYA5D

4-channel mixers phono/line/microphone and 1 USB port

Code : H9879

269€ incl. VAT



#### Inputs

- 1 USB port on channel 4 allowing playback and recording through a computer
- 2 phono through RCA
- 4 lines through RCA
- 1 microphone through combo connector on front panel
- 1 microphone through jack connector on back

#### Adjustments

- 3-band equaliser on stereo channels
- 3-band equaliser on microphone channels
- Gain adjustment for each channel

#### Outputs

- Master A balanced and unbalanced output
- Master B unbalanced output
- Record output
- Pre-listen output on 6.35 stereo jack
- 1 USB audio port to connect to a computer

LED VU-meters on each channel and Master

Power supply: AC 230V ~ 50Hz  
Dimensions: 254 x 295 x 104mm  
[85mm-deep flush-mounting]  
Weight: 3.4 Kg



### BATTLE4-usb

DJ Mixer, 9 inputs on 4 channels [3 line inputs, 2 phono, 2 microphones, 2 USB]

Code : B00126

179€ incl. VAT



#### Inputs

- 2 USB ports on channels 2 and 3 allowing playback and recording of audio files
- 3 line inputs
- 2 phono
- 2 microphones

#### Adjustments

- 3-band equaliser on each channel
- 2-band equaliser on microphone channel
- Gain adjustment for each channel

#### Outputs

- Balanced Master
- Separate Booth and Record
- 2 USB ports

Master LED VU-meters per channel  
Power supply: AC 230V ~ 50Hz  
Dimensions: 237 x 315 x 105 mm  
Weight: 3.3 Kg



### DIGITAL-3

3-channel mixer with 1 microphone and 2 USB

Code : H9254

179€ incl. VAT



#### Inputs

- 2 USB ports on channels 1 and 3 allowing playback and recording of audio files
- 3 phono through RCA
- 3 line through RCA
- 1 microphone through jack with Talkover

#### Adjustments

- 3-band equaliser on each channel
- 2-band equaliser on microphone channel
- Gain adjustment for each channel

#### Outputs

- Master output, high level
- 2 USB ports

On/off switch  
LED VU-meter for Master  
External power supply  
Dimensions: 254 x 308 x 82.5 mm  
Weight: 3.4 kg



### DIGITAL-2

2-channel DJ Mixer with 1 microphone and 2 USB

Code : H8682

149€ incl. VAT



#### Inputs

- 2 USB ports allowing playback and recording of audio files
- 2 PHONO inputs with switchable RCA connectors
- 2 LINE inputs with switchable RCA connectors
- 1 DJ mic input with jack connector and TALKOVER

#### Adjustments

- Low/mid correction -12/+12 dB through DJmic channel
- Gain and lows/mids/highs correction -15/+15 on stereo channels

#### Outputs

- Unbalanced Master output through RCA
- Headphone output
- 2 USB ports

General LED VU-meter with 10 sections  
External power supply  
Dimensions: 178 x 270 x 85 mm  
Weight: 1.9 Kg



### CLUB7-usb

DJ Mixer, 13 inputs over 7 channels [3 microphones, 5 line, 2 phono or 2 USB, 1 auxiliary]

Code : B00125

299€ incl. VAT



#### Inputs

- 2 USB ports on channels 2 and 3 allowing playback and recording of audio files
- 3 microphones with Talkover
- 5 lines,
- 2 phono or 2 USB,
- 1 auxiliary or Player

Integrated USB/SD reader for mp3, WAV or WMA files

#### Adjustments

- 3-band equaliser on each channel
- Gain adjustment for each channel
- Talkover level adjustment

#### Outputs

- Balanced Master
- Separate Booth and Record
- 2 USB ports

LED VU-meters for channels 1-4  
Power supply: AC 230V ~ 50Hz  
Dimensions: 483 x 222 x 78 mm  
Weight: 4.5 Kg



### KM 4.1

Echo unit combined with a small mixer, perfect for karaoke.

Code : B00289

109€ incl. VAT



#### Inputs

- 2 mic with Talkover on back
- 2 line

#### Adjustments

- General 3-band equaliser
- Level adjustment for each input
- General level adjustment
- Echo chamber adjustment (delay, repeat, echo)

#### Output

- Unbalanced mix output

Power supply: AC 230V ~ 50Hz  
Dimensions: 483 x 44 x 180 mm  
Weight: 2 Kg

# MIDI CONTROLLERS

## TAKE CONTROL:

Hard drives and USB drives, DJ software, external CD or vinyl player.

The DJinn Pro is placed at the centre of your sound booth and of your sound booth and removes the boundaries of mixing. Without a computer, it is a USB hard drive reader with synchronised effects, advanced looping system and HotCue, offering total control over your music files. Once connected, the MIDI controller function is added, compatible with most software on the market, and provided with Virtual DJ LE. Forward-thinking and well thought-out, you can even plug your analogue sources and benefit from a full mixing desk.



### DJinnPro

Mixer / USB player/ Professional MIDI controller provided with Virtual DJ LE

Code : H9932

469€ incl. VAT



Windows  
macOS

**Reader**  
2 USB readers  
4 effects that can be synchronised with the tempo, 4 Hot Cue presets  
Advanced looping system  
Total control with touch-sensitive rotary plates  
Variable pitch with Master Tone

**Controller**  
MIDI-compatible DJ software controller (MacOS and Windows)  
All keys compatible with MIDI (readers and mixer)  
Low-latency USB MIDI/Audio system  
Latest version of VirtualDJ LE included

**Mixer**  
Complete digital/analogue mixing desk  
ASIO multitrack sound card with balanced output  
2-channel mixer with source selection

(PC, Line or Phono)  
Two mic inputs with MIC OVER  
Two outputs with separate levels (Master and Booth)  
Headphone output with volume and Cue  
Mix adjustment  
Double LED VU-meter with Cue or Master function  
Large screen with VFD display  
Mp3 file search system in tree structure

Power supply: AC 100-240V-60/50Hz  
Dimensions: 420 x 298.8 x 89 mm  
19-inch rack [EQ-DJinn bracket optional]  
Weight: 4.42 Kg

Can be used on up-to-date computer with Windows® XP/Vista/7/8/10 or Mac® OS X

## ADD DJAZZ TO YOUR MIX

DJazz Pro is a complete DJ controller allowing you to mix music on your Mac or PC by playing loops, samples, effects, etc. Versatile, easy to use and with unlimited possibilities, DJazz offers the best in DJ controllers, whether you are a beginner or professional.

Compatible with all the major software, its universal consumer or professional connectivity, its complete and fully-integrated software deliver a tool software make it a tool really focused on the pleasure of playing music.



### DJazz Pro

Professional DJ MIDI control surface with multi-channel ASIO sound card

Code : H9923

259€ incl. VAT



Windows  
macOS

DJ software controller compatible with MIDI (Mac OS X and Windows)  
- Native MIDI compatibility (driverless)  
- Standard MIDI USB input/output

Complete digital audio interface  
- Compatible with Windows (WDM) without driver  
- Compatible with Windows via ASIO driver (multitrack)  
- Compatible with MacOSX (Core Audio) without driver  
- Dedicated ASIO driver included  
- 1 line/phono stereo input through RCA compatible with CD/Vinyl Timecode  
- 1 line/phono stereo input through RCA with input gain management and Thru mode, compatible with CD/Vinyl Timecode  
- 1 aux stereo input through mini-jack with input gain management and Thru mode

- 1 mic input through 6.35 jack  
- Headphone with Cue/Mix  
- Balanced output through 6.35 jack  
- Unbalanced output through RCA  
- REC output through USB port

- A/D Conversion: 24-bit – 96kHz  
- Sampling rate: 16-bit 44.1/48kHz

Other specifications  
- Power supply: USB 5V 500mA  
- Optional external power supply: 6V 2.0A  
- Dimensions: 410 x 297 x 65 mm  
- Weight: 2.9 kg

Provided with Virtual DJ LE, ASIO driver, and mapping for Virtual DJ Pro and Traktor Pro  
Can be used on up-to-date computer with Windows® XP/Vista/7/8/10 or Mac® OS X



### DJ-KONTROL 4

Professional 4-channel MIDI controller for DJ

Code : B00385

299€ incl. VAT



Windows  
macOS



**Controller**  
MIDI-compatible DJ software controller (MacOS and Windows)  
Thanks to the MIDI communication protocol, this controller can be used with any other MIDI DJ software.  
8 large touch-sensitive buttons for cues, loops, samples, slices and effect adjustment.  
Scratching jog wheel with coloured backlight.  
Latest version of VirtualDJ LE included

**Mixer:**  
3-band equaliser with additional filter adjustment button.  
Microphone input.  
Headphone output with PFL/MIX  
XLR and RCA master outputs  
RCA monitor output  
RCA record output  
2 stereo RCA line inputs

A/D Conversion: 24-bit

LED VU-meter  
Power supply: USB 5V 500mA or 5V 1A external power supply  
Dimensions: 533 x 280 x 70 mm  
Weight: 2 kg

Can be used on up-to-date computer with Windows® XP/Vista/7/8/10 or Mac® OSX



### DJ-KONTROL 3S

Professional MIDI controller for DJs (travelling DJ, clubs, studios, etc.).

Code : B00384

219€ incl. VAT



Windows  
macOS



**Controller**  
MIDI-compatible DJ software controller (MacOS and Windows)  
Thanks to the MIDI communication protocol, this controller can be used with any MIDI software for DJs.  
Most buttons are backlit: easy to use in the dark.  
Touch-sensitive scratching jog wheels with blue backlight

Provided with the latest version of VirtualDJ LE  
**Mixer:**  
3-band equaliser with push-kill button  
DJ mic input  
PFL headphone output  
Crossfader curve adjustment. XLR and RCA master outputs

Integrated 24-bit/192kHz sound card

LED VU-meter  
Power supply: USB 5V 500mA  
Dimensions: 320 x 240 x 65 mm  
Weight: 1.4 kg

Can be used on up-to-date computer with Windows® XP/Vista/7/8/10 or Mac® OSX



### EQ-DJinn

19" brackets for DJinn and DJinnPro

Code : H9856

17€ incl. VAT



### Brackets for DJ-KONTROL 3

19" brackets for DJ-KONTROL 3 and 3S.

Code : B00392

9,90€ incl. VAT



Material: steel  
Finish: black lacquer

19" brackets for DJ-KONTROL 3 and 3S.

# CD PLAYERS



Adjustable automatic and manual loops, effects synchronised to tempo, HotCue, Samples and and Scratch are just some examples of its capacity.

Capable of reading mp3 CDs, and USB supports (keys or hard drives), it transforms into a controller that can be used with most DJ software, and allows you to play using all supports.

**CDX6**  
CD/USB mass storage player and MIDI controller

Code : H9574      349€ incl. VAT

Windows  
macOS

CD MP3 slot in reader  
USB reader on two ports for keys or external hard drive.  
MIDI controller via USB on back

DSP with Echo, Flanger, Filter, Reverse and Scratch effects.  
Touch sensitive panel with illuminated ring for control  
3 Jog modes: Vinyl, BEND and A.Cue scratch

Adjustable pitch with Master Tempo  
4 HOT CUE points  
4 samples in memory  
Synchronisation of effects with tempo  
Adjustable smart loop  
Auto or manual BPM



Next track reserve to choose next track to be played  
USB link to connect two players to a shared hard drive

Large screen with VFD display  
ID3Tag visualisation of artists, titles and genres  
Tree structure mp3 file search system.

Xstart for cue start with crossfader on equipped mixers

Dimensions: 296 x 218 x 104 mm  
Weight: 2.4kg

Can be used on up-to-date computer with Windows® XP/Vista/7/8/10 or Mac® OSX

**CDX4**  
USB and CD mp3 player with effects and SMART LOOP

Code : H9812      239€ incl. VAT

CD MP3 slot in reader  
USB mass storage player for USB drive or hard drive

DSP with Scratch, Flanger, Filter, Echo, Reverse effects with adjustable level and settings.  
Multifunction touch-sensitive rotary table

Adjustable pitch with Master Tone  
SMART LOOP: Loop with adjustable length according to tempo  
Auto loop with adjustable length according to tempo  
AVM: Anti Vibration Memory  
Auto-Cue and track order programming

Highly readable blue LCD display  
ID3Tag visualisation of artists, titles and genres  
Tree structure mp3 file search system.

Analogue and digital output  
Xstart and Relay connections

Dimensions: 220 x 315 x 100 mm  
Weight: 2.5 kg





CD/USB/SD players. Rack-mountable CD, USB or SD players for live applications in sound booth, with DJ, theatre, or entertainment-oriented functions, you will certainly find a model that suits your needs among our players.



**USB 2.2 Mk2**  
Double CD player with two USB ports

---

Code : B00363      449€ incl. VAT

---



Double CD player, Mp3, Wave and CDA USB player with double USB mass-storage input (on front and back)

Jog wheel with two modes: Vinyl and pitch bend  
Advanced random playback functions  
Adjustable pitch with Master Tempo  
Auto and manual BPM, perfect loop (IN/OUT/RELOOP)  
AVM: Anti Vibration Memory  
Auto CUE

Alphanumerical LCD screen allows reading ID3V2 tags (track title, artist and sampling rate).  
Tree structure mp3 file search system.

Xstart for cue start with crossfader on equipped mixers

Player dimensions 482 x 89 x 267mm  
Remote dimensions 482 x 89 x 94 mm  
Weight: 4.6kg (player) 1.7kg (remote)



**USB 1.1 REC**  
CD/USB player + recorder

---

Code : B00365      339€ incl. VAT

---



CD Mp3, Wave and CDA player USB player with double USB mass-storage input (on front and back)

Lossless recording from an external source in WAV or MP3 files (bitrate: 64, 128, 192, 256 and 320kbit/s), even during playback of CD tracks or USB devices.  
Auto or manual recording processor: for a simple recording process without distortion

Variable pitch with Master Tone  
Auto and manual BPM, perfect loop (IN/OUT/RELOOP)  
AVM: Anti Vibration Memory  
Auto CUE

Large screen with VFD display  
ID3Tag visualisation of artists, titles and genres  
Tree structure mp3 file search system.

Infrared remote control included for playback, recording, looping, search, pitch, and volume functions.

Right/left output through XLR and RCA

Dimensions: 482 x 89 x 270 mm  
Weight: 4.35 kg



**MPu320**  
Double CD player with two USB mass-storage ports and touch-sensitive jog wheels

---

Code : H9681      449€ incl. VAT

---



Double CD player, Mp3, Wave and CDA USB player with double USB mass-storage input (on front and back)

Jog wheel with two modes: Jog scratch and pitch bend  
Variable pitch with Master Tone  
Auto and manual BPM, perfect loop (IN/OUT/RELOOP)  
AVM: Anti Vibration Memory  
Auto CUE

Large screen with VFD display  
ID3Tag visualisation of artists, titles and genres  
Tree structure mp3 file search system.

Xstart for cue start with crossfader on equipped mixers, Relay for continuous playback

Player dimensions 482 x 89 x 263 mm  
Remote dimensions 482 x 91 x 94 mm  
Weight: 5.1kg (player) 1.9kg (remote)



**MPu310**  
Mp3-compatible CD/USB player with infrared remote and XLR/RCA output

---

Code : H9680      319€ incl. VAT

---



CD Mp3, Wave and CDA player USB player with double USB mass-storage input (on front and back)

Variable pitch with Master Tone  
Auto and manual BPM, perfect loop (IN/OUT/RELOOP)  
AVM: Anti Vibration Memory  
Auto CUE

Large screen with VFD display  
ID3Tag visualisation of artists, titles and genres  
Tree structure mp3 file search system.

Infrared remote control included for playback, recording, looping, search, pitch, and volume functions.

Right/left output through XLR and RCA

Dimensions: 482 x 89 x 270 mm  
Weight: 5.1 kg

# VINYL TURNTABLES

Back to the source. Listen to your favourite albums on high-quality vinyl, protect your collection with easy-to-use solutions offering unmatched sound quality thanks to our vinyl-dedicated range of products.



## XTRM-1

Direct Super High torque motor + line out

Code : B00322 399€ incl. VAT



Direct Drive 3-phase Super High Torque motor with extreme torque of 4.5kg/cm  
Adjustable start and stop time from 0.2 to 6 seconds  
3 speeds: 33, 45, 78 rpm with quartz lock and optical sensors  
Pitch at  $\pm 10\%$   $\pm 20\%$   
Standard or reverse playback  
2 Start/Stop buttons  
White LED lighting on cartridge  
Phono or Line output on back  
High-quality S-shaped metal tonearm with adjustable height.  
Special anti-resonant frame  
Tall adjustable support legs  
Dimensions: 450 x 353 x 86 mm  
Weight: 12 kg  
Comes with cartridge holder, felt mat and 45 rpm adapter



## Q3usb

USB direct motor + line output

Code : B00353 269€ incl. VAT



Direct Drive 3-phase High Torque motor with torque higher than 1.6kg/cm  
Quick start/stop  
3 speeds: 33, 45, 78 rpm with quartz lock  
Pitch at  $\pm 10\%$   $\pm 20\%$   
Standard or reverse playback  
White lighting on cartridge  
Phono or Line output on back  
High-quality S-shaped metal tonearm with adjustable height.  
Adjustable support legs to level the turntable  
Dimensions: 450 x 352 x 157 mm  
Weight: 10.5 kg

USB output for direct recording onto any computer using Audacity software, which can be downloaded for free, so as to:  
change the speed and key, reduce noise, equalise, import and export files, etc.

Comes with dust cover, Audio Technica cartridge, USB cable, felt mat, 45 rpm adapter



## Q1usb

Belt drive  
USB + line output

Code : B00352 219€ incl. VAT



Belt-drive motor Quick start/stop  
2 speeds: 33, 45 rpm  
Pitch at  $\pm 10\%$   
Phono or Line output on back  
Retractable white lighting on cartridge  
S-shaped metal tonearm assembled with:  
- Counterweight- Anti-skating control - Arm lever  
Adjustable support legs to level the turntable  
Dimensions: 450 x 350 x 150 mm  
Weight: 9.0 kg

USB output for direct recording onto any computer using Audacity software, which can be downloaded for free, so as to:  
change the speed and key, reduce noise, equalise, import and export files, etc.

Comes with dust cover, Audio Technica cartridge, USB cable, felt mat, 45 rpm adapter



## S-15

AUDIOTECNICA cartridge complete with needle

Code : H4369 24€ incl. VAT



Spherical type  
Frequency: 20 to 20,000Hz  
3 to 4g tracking force



## STYLUS-15

Replacement needle for S-15

Code : H4371 16€ incl. VAT



Spherical type  
Frequency: 20 to 20,000Hz  
3 to 4g tracking force



## HEADSHELL-NO

Black metal cartridge holder

Code : H4373 6,50€ incl. VAT



Fits all turntables and most cartridges on the market.



## TT-CASE

High-quality modern flight-case for DJ turntables (T2, T3, X-TRM1, SL1200, etc.).

Code : B03206 59€ incl. VAT

High-quality modern flight-case for DJ turntables (T2, T3, X-TRM1, SL1200, ...).  
2 butterfly latches, solid handle, interior finish in shock-absorbing foam rubber

**NEW**

**ATN3600L**  
Audio Technica AT3600 & AT3600L replacement needle  
Code: B08200 17€ incl. VAT

**AT91/BL**  
Hi-Fi Audio Technica AT91BL cartridge  
Code: B08201 27€ incl. VAT

**AT91**  
Audio-Technica ATN91 replacement needle  
Code: B08202 18€ incl. VAT

# MICROPHONES



Hear the difference with the range of microphones and HF systems from Audiophony® and JBsystems®. These models are amongst the greatest references of the audio world, constantly striving for better performance and ergonomics in the service of sound professionals.



**RP1**  
Dynamic cardioid microphone for voice

---

Code : H9654      38,90€ incl. VAT

---



Use: Vocals  
Type: Dynamic cardioid  
Finish: Moulded aluminium body, reinforced anti-shock grill and pop filter  
Connection: XLR  
Impedance: 600Ω +/-30% @ 1KHz  
Frequency response: 70Hz - 16kHz  
Sensitivity: -53dB +/-3dB  
Weight: 360 g  
Dimensions: 180 x 53mm



**RS1**  
Dynamic microphone for voice

---

Code : H9653      27,90€ incl. VAT

---



Use: Vocals  
Type: Dynamic cardioid  
Finish: Moulded aluminium body, reinforced anti-shock grill and pop filter  
Connection: XLR  
Impedance: 600Ω +/-30% @ 1KHz  
Frequency response: 40Hz - 16kHz  
Sensitivity: -52dB +/-3dB  
Weight: 355 g  
Dimensions: 185 x 50 mm



**JB27**  
Professional microphone

---

Code : B00410      45,90€ incl. VAT

---



Use: Vocals  
Type: Dynamic cardioid  
Finish: Moulded aluminium body, reinforced anti-shock grill and pop filter with ON/OFF  
Connection: XLR  
Impedance: 250Ω  
Frequency response: 50Hz - 18kHz  
Sensitivity: -72dB  
Comes with case, clamp and 6m XLR to mono jack cable



**JB10**  
Professional dynamic microphone

---

Code : B00402      36,90€ incl. VAT

---



Use: Dynamic microphone for entertainment and speech  
Type: Dynamic cardioid  
Finish: Metal body and solid build with ON/OFF button  
Connection: XLR  
Impedance: 500 Ω  
Frequency response: 70Hz - 14kHz  
Sensitivity: -75dB  
Comes with case, clamp and 6m XLR to mono jack cable



**DMC62**  
Dynamic microphone for entertainment and speech

---

Code : H9652      23,90€ incl. VAT

---



Use: Dynamic microphone for entertainment and speech  
Type: Dynamic cardioid  
Finish: Metal body and solid build with ON/OFF button  
Connection: XLR  
Impedance: 500 Ω  
Frequency response: 80Hz - 15kHz  
Sensitivity: -54dB  
Comes with case, clamp and 6m XLR to mono jack cable



**JB5**  
Semi-professional dynamic microphone for DJ, voice or music

---

Code : B00408      17,90€ incl. VAT

---



Use: Dynamic microphone for entertainment and speech  
Type: Dynamic cardioid  
Finish: Metal body and solid build with ON/OFF button  
Connection: moulded cable with jack connector  
Impedance: 600 Ω  
Frequency response: 100Hz - 12kHz  
Sensitivity: -74dB  
Comes with 2m mono jack cable



**JB30**  
Gooseneck microphone

---

Code : B00411      49€ incl. VAT

---



Use: Dynamic gooseneck microphone for speech  
Type: Unidirectional microphone  
Finish: 30cm metal gooseneck with ON/OFF button  
Connection: XLR  
Impedance: 500 Ω  
Frequency response: 80Hz - 14kHz  
Sensitivity: -74dB



**JB33**  
Suitable for conferences, etc.

---

Code : B00406      39€ incl. VAT

---



Use: Conference gooseneck microphone  
Type: Condenser Electret 1.5V  
Finish: 23cm metal gooseneck with ON/Standby/OFF button  
Connection: 3.5 and 6.35 jack  
Impedance: 1000 Ω  
Frequency response: 70Hz - 16kHz  
Sensitivity: -66dB

# MICROPHONES



## PACK-UHF410-Head

Code : H10283 299€ incl. VAT



Pack including:  
 1 UHF410-Base receiver  
 1 UHF410-Body waistband transmitter  
 1 UHF410-Head headset microphone  
 1 carrying case



## PACK-UHF410-Lava

Code : H10284 299€ incl. VAT



Pack including:  
 1 UHF410-Base receiver  
 1 UHF410-Body waistband transmitter  
 1 UHF410-Lava lavalier microphone  
 1 carrying case



## PACK-UHF410-Hand

Code : H10282 269€ incl. VAT



Pack including:  
 1 UHF410-Base receiver  
 1 UHF410-Hand handheld microphone  
 1 carrying case



## UHF410-Base

UHF true diversity receiver with auto scan and sync function

Code : H10271 199€ incl. VAT



True Diversity receiver  
**New frequency ranges UHF 823 ~ 832 and 863 ~ 865 MHz, 4G compatible**  
 Programmed frequencies with auto-scan function  
 Presets for 4 groups, 4 channels  
 LCD display: frequency, group, channel, RF & AF  
 Balanced and unbalanced audio output through XLR and 6.35 mono jack  
 Line or Mic level  
 Volume level adjusted through rotary switch on front  
 Detachable BNC antennae, multiple accessories available  
 Power supply: 12V DC (adapter provided)  
 Dimensions: 200 x 42 x 183mm (rack-mountable 19 inch by two)



## UHF410-Hand

Condenser handheld microphone transmitter

Code : H10272 79€ incl. VAT



Handheld electret condenser microphone  
 True Diversity transmitter  
**New frequency ranges UHF 823 ~ 832 and 863 ~ 865 MHz, 4G compatible**  
 Output power: 10mW (max.)  
 40 programmed frequencies with SYNC function  
 LCD display: channel, battery level  
 Power supply: 2 AA 1.5V batteries (not included)  
 Average battery life: 10 hours  
 Dimensions: 260 x 54mm diameter



## UHF410-Body

UHF diversity waistband transmitters

Code : H10273 79€ incl. VAT



True Diversity Transmitter  
**New frequency ranges UHF 823 ~ 832 and 863 ~ 865 MHz, 4G compatible**  
 Output power: 10mW (max.)  
 40 channels with auto-scan function  
 LCD display: channel, battery level  
 Mic input through mini XLR  
 Gain level -10/0/+10dB  
 Power supply: 2x AA type 1.5V batteries (not included)  
 Battery life: 10 hours on average  
 Dimensions: 98 x 65 x 25mm (+ 75mm for antenna)



## UHF410-Head

Sweatproof headset microphone

Code : H10274 29€ incl. VAT



Sweatproof headset electret condenser microphone, ideal for sport clubs  
 Sensitivity: -47 ±4dB  
 Polarity: Unidirectional cardioid  
 Frequency response: 100Hz - 10KHz  
 Operating voltage: 1.5V  
 Power consumption: 0.5mA max.  
 Signal to noise ratio: Higher than 60dB  
 Accessories included: Windscreen  
 Connectivity: Mini XLR



## UHF410-Lava

Discrete lavalier condenser microphone

Code : H10275 25€ incl. VAT



Miniature lavalier electret condenser microphone  
 Sensitivity: -47 ±4dB  
 Polarity: Omnidirectional cardioid  
 Frequency response: 50Hz - 10KHz  
 Operating voltage: 1.5V  
 Power consumption: 0.5mA max.  
 Signal to noise ratio: Higher than 58dB  
 Accessories included: Windscreen and fastening pin  
 Connectivity: Mini XLR  
 Dimensions: 37 x 5.5mm diameter





**UHF-410-Boost**  
Booster antenna with BNC connector

Code : H10276 35€ incl. VAT



Gain from 9 dB +/-1dB  
Frequency range: 550-950MHz  
Operating voltage: 8V  
Impedance 50Ω



**UHF410-Hold**  
Antenna support with BNC connector

Code : H10277 16€ incl. VAT



5/8" threading for microphone stand and male/male BNC connector



**UHF410-Split**  
2-in-1 Splitter IN/OUT with BNC connector

Code : H10278 65€ incl. VAT



Frequency range: 400 ~ 1000MHz  
Stationary wave report (VSWR): < 2  
Input impedance: 50 Ω  
Isolation: 18dB  
Loss: < 3dB  
Connectors: BNC  
Dimensions: 77 x 64 x 26 mm



**UHF410-Ant**  
Long range directional antenna with BNC connector

Code : H10279 299€ incl. VAT



Frequency range: 500 ~ 950 MHz  
Beam width:  
80° E-plane, 140° H-plane  
Impedance: 50 Ω  
Connector: BNC  
Dimensions: 295 x 210 x 31 mm



**UHF410-Rall1m**  
BNC/BNC 1 metre antenna extension cable

Code : H10280 17€ incl. VAT



**UHF410-Rall10m**  
BNC/BNC 10 metre antenna extension cable

Code : H10281 69€ incl. VAT



**UHF410-BNC2**  
BNC/BNC connector for bracket

Code : H10639 4€ incl. VAT



**UHF410-Rack**  
Long bracket for receiver

Code : H10640 7€ incl. VAT



**UHF410-BNC1**  
BNC/BNC connector for extension

Code : H10641 4€ incl. VAT



The UHF410 range benefits from the latest technological developments for an optimal transmission quality.

This range meets European requirements and uses the frequency ranges 823 ~ 832 and 863 ~ 865 MHz, that are compatible with 4G.



# MICROPHONES



## GO-Lava pack

Code : H10000 169€ incl. VAT



Pack including:  
1 GO-MONO receiver  
1 GO-MONO waist transmitter  
1 GO-Lava lavalier mic



## GO-Head pack

Code : H10001 169€ incl. VAT



Pack including:  
1 GO-MONO receiver  
1 GO-Body waist transmitter  
1 GO-Head headset microphone



## GO-Hand pack

Code : H9999 159€ incl. VAT



Pack including:  
1 GO-MONO receiver  
1 GO-Hand handheld microphone



## GO-Mono

UHF diversity receiver, 16 frequencies for 1 transmitter

Code : H9988 99€ incl. VAT



UHF 16-frequency receiver  
**New frequency ranges UHF 823 ~ 832 and 863 ~ 865 MHz, 4G compatible**  
Diversity system for reception free of micro-cuts.  
Adjustable squelch for parasite absorption  
Simultaneous operation of 4 receivers (4 mics)  
Adjustable antennae on front  
Average range 70m in ideal conditions  
Balanced XLR and unbalanced jack outputs  
Rack-mountable by two via FREE-RACK (optional)  
Dimensions: 130 x 36 x 92 mm

The UHF GO range benefits from the latest technological developments for an optimal transmission quality.

Equipped with entirely redesigned electronics, the transmitters and receivers now allow using 4 microphones simultaneously with an optimal reception quality.

Easy to use, the GO Mono transmitter allows receiving from a Diversity transmitter, with a choice of 16 frequencies.

- Compatible with the new TNT and 4G frequencies
- Up to 4 mics simultaneously
- Balanced and unbalanced output
- Implies the use of 4 transmitters and 4 receivers in the GO range





### GOHand

UHF transmitter handheld condenser microphone

Code : H9989

69€ incl. VAT



Handheld microphone only  
Must be paired with a GO-MONO receiver  
**New frequency ranges UHF 823 – 832 and 863 – 865 MHz, 4G compatible**  
High-end Electret condenser capsule  
Distortion rate lower than 1% @ 1kHz  
Works with AA-type 1.5V batteries  
Dimensions: 237 x 58 mm



### GOBody

Waist transmitter housing for lavalier or headset microphone

Code : H9990

49€ incl. VAT



Pocket UHF transmitter 16 frequencies  
**New frequency ranges UHF 823 – 832 and 863 – 865 MHz, 4G compatible**  
Mini XLR connector  
Adjustable impedance on either Line or Mic position  
Works with AA-type 1.5V batteries  
Dimensions: 65 x 100 x 27 mm



### GOHead

Mini XLR condenser headset microphone

Code : H9991

27€ incl. VAT



Headset microphone only  
Must be paired with a GO-BODY transmitter and a GO-MONO receiver.  
Mini XLR connector  
Comes with windscreen and adjustable headband  
Unidirectional condenser capsule  
Frequency response: 100Hz to 16kHz  
S/N: > 60dB  
Impedance: 2.2 kOhms



### GOLava

Mini XLR condenser lavalier microphone

Code : H9992

24€ incl. VAT



Lavalier microphone only  
Must be paired with a GO-BODY transmitter and a GO-MONO receiver.  
Mini XLR connector  
Comes with windscreen and clamp  
Unidirectional condenser capsule  
Frequency response: 100Hz to 16kHz  
S/N: > 60dB  
Impedance: 2.2 kOhms



### BODYPOCKET

Neoprene waistband for UHF-BODY transmitter

Code : H10484

15€ incl. VAT



Compatible with most transmitters on the market  
Ideal for sports clubs



### MICRO CASE 3U

Rack 19" 3U 230mm/300mm

Code : B03221

99€ incl. VAT



Flight case for 19-inch HF microphone receiver.  
Depth 230mm (300mm with cover)



### FREE-RACK

19 inch rack bracket for 2 GO receivers

Code : H9374

39€ incl. VAT



Material: Steel  
Finish: Black paint

# MICROPHONES



## WMS-10

UHF wireless microphone system comprising WMIC-10 handheld microphone and receiver.

Code : B00438 169€ incl. VAT



UHF wireless microphone system comprising WMIC-10 handheld microphone and 16-frequency UHF receiver.  
 Frequency range: 863 – 865 MHz  
 Diversity system for reception free of micro-cuts.  
 Adjustable squelch for parasite absorption  
 Simultaneous operation of 4 receivers (4 mics)  
 Adjustable antennae on front  
 Balanced XLR and unbalanced jack outputs  
 Rack-mountable by two via RP-WMIC 19" (optional)  
 UHF handheld microphone with 16 frequencies  
 Dynamic unidirectional capsule  
 Distortion rate lower than 1% @ 1kHz  
 Works with AA-type 1.5V batteries



## WBS-20

UHF wireless microphone system comprising WBP-20 waistband housing, lavalier microphone and receiver.

Code : B00439 169€ incl. VAT



UHF wireless microphone system comprising WBP-20 waistband housing, lavalier microphone and 16-frequency UHF receiver.  
 Frequency range: 863 – 865 MHz  
 Diversity system for reception free of micro-cuts.  
 Adjustable squelch for parasite absorption  
 Simultaneous operation of 4 receivers (4 mics)  
 Adjustable antennae on front  
 Balanced XLR and unbalanced jack outputs  
 Rack-mountable by two via RP-WMIC 19" (optional)  
 UHF waistband housing with 16 frequencies  
 Mini XLR connector  
 Adjustable impedance on either Line or Mic position  
 Works with AA-type 1.5V batteries  
 Distortion rate lower than 1% @ 1kHz  
 Unidirectional Electret capsule lavalier microphone



## WBP-20

Optional waistband housing.

Code : B00441 89€ incl. VAT



UHF waistband housing with 16 frequencies  
 Mini XLR connector  
 Adjustable impedance on either Line or Mic position  
 Works with AA-type 1.5V batteries  
 Distortion rate lower than 1% @ 1kHz



## WMIC-10

UHF receiver handheld microphone

Code : B00440 89€ incl. VAT



UHF handheld microphone with 16 frequencies  
 Dynamic unidirectional capsule  
 Distortion rate lower than 1% @ 1kHz  
 Works with AA-type 1.5V batteries



## WHS-20

Mini XLR condenser headset microphone

Code : B00442 35,90€ incl. VAT



Headset microphone for musicians, teachers and fitness clubs  
 Must be paired with a WBP-20 transmitter  
 Mini XLR connector  
 Comes with windscreen and adjustable headband  
 Unidirectional condenser capsule  
 Frequency response: 100Hz to 16kHz  
 S/N: > 60dB  
 Impedance: 2.2 kOhms



## RP-WMIC

19" adapter for 1 or 2 receivers (WMS-1 or WBS-2 set).

Code : B00437 39€ incl. VAT



19" adapter for 1 or 2 receivers (WMS-1 or WBS-2 set).



The Wave was designed to provide high-fidelity vocal reproduction. Ideal for events and presentations, you can count on its battery life and long range for a VHF microphone. Its dynamic capsule perfectly preserves the timbre and intonation of your voice.

VHF receiver with handheld microphone. 2 available frequencies: VHF 177.5MHz and 185.3MHz for simultaneous use of two microphones.

- **Compatible with TNT and 4G frequencies**
- **Battery life of almost 8 hours**
- **Dynamic handheld microphone**
- **Range up to 50m**



**WAVE-F1**  
VHF receiver with handheld microphone.

---

Code : H9549      57,90€<sup>incl. VAT</sup>

---



Carrier frequency:  
- 177.5MHz for WAVE-F1

- Receiver:
- Output level adjustment to avoid signal saturation.
  - Unbalanced 6.35 jack output (jack/ jack cord provided)
  - AC adapter power supply included: DC 9V 300mA

- Transmitter microphone:
- Dynamic cardioid capsule handheld microphone.
  - Plastic body and reinforced metal grill.
  - OFF/Mute/ON switch
  - Pop filter.
  - Frequency response: 40 to 13kHz
  - Signal to noise ratio: 80 dB
  - Range: up to 50m on average with no dead zone
  - 9V (6LR-61) battery powered (included)



**WAVE-F2**  
VHF receiver with handheld microphone.

---

Code : H9550      57,90€<sup>incl. VAT</sup>

---



Carrier frequency:  
- 185.3MHz

Other features identical to WAVE-F1

# AUDIO HEADPHONES



## YC100

Closed wired headphones Comfortable on all levels

Code : H10129 39€ incl. VAT



Transducer type: Dynamic  
 Driver diameter: 50mm  
 Impedance: 60 Ω  
 Sensitivity: 100dB +/-3dB  
 Power handling: 1000mW  
 Frequency response: 10Hz - 20kHz  
 Cable: 4mm x 2.2m  
 Connectivity: 3.5mm with 6.35mm adapter included  
 Weight: 310 g



## HPS-2

Professional DJ headphones

Code : B00508 59€ incl. VAT



Transducer type: Dynamic  
 Driver diameter: 50mm  
 Impedance: 29 Ω  
 Sensitivity: 101 dB +/-3 dB  
 Power handling: 1000mW  
 Frequency response: 15 Hz - 22 kHz  
 Cable: 3m coiled cable and smartphone cable with integrated microphone  
 Connectivity: 3.5mm with 6.35mm adapter included  
 Weight: 280 g



## DJ-950

Closed dynamic headphones with directional earpieces and bass boost. Special for DJ.

Code : H8222 29,90€ incl. VAT



Driver diameter: 57 mm  
 Impedance: 64 Ω  
 Sensitivity: 113 dB  
 Maximum power: 3.5W  
 Frequency response: 5 - 30kHz  
 Cable: 4m with 3.5/6.35 jack adapter and right-angled 6.35  
 Carrying case and replacement ear pads included



## HP2000 PRO

Professional high-performance earphones for DJ.

Code : B00505 32,90€ incl. VAT



Driver diameter: 57 mm  
 Impedance: 64 Ω  
 Sensitivity: 107 dB  
 Maximum power: 3500 mW  
 Frequency response: 5 - 30kHz  
 Cable: 3m coiled cable with 3.5/6.35 jack adapter and right-angled 6.35  
 Carrying case and replacement ear pads included  
 Weight: 290 g



## HP1500 PRO

Stereo DJ earphones.

Code : B00507 22,90€ incl. VAT



Driver diameter: 57 mm  
 Impedance: 32 Ω  
 Sensitivity: 108 dB  
 Maximum power: 3500 mW  
 Frequency response: 20 - 20 kHz  
 Cable: 3m coiled cable with 3.5/6.35 right-angled jack adapter  
 Carrying case  
 Weight: 160 g



## DJ-930

Dynamic semi-closed headphones with directional earpieces

Code : H8223 21,90€ incl. VAT



Driver diameter: 57 mm  
 Impedance: 64 Ω  
 Sensitivity: 107 dB  
 Maximum power: 3.5W  
 Frequency response: 30 - 18 kHz  
 Cable: 4m with 3.5/6.35 jack adapter  
 Carrying case included



### HeadZ Fuchsia

The best of light earphones + mic with outstanding sound quality for your smartphone, tablet, laptop, etc.

Code : B00512      22,90€ incl. VAT



### HeadZ White

The best of light earphones + mic with outstanding sound quality for your smartphone, tablet, laptop, etc.

Code : B00513      22,90€ incl. VAT



### YBT-100G

High-fidelity Bluetooth stereo headphones  
Comes with carrying case

Code : H10303      35€ incl. VAT

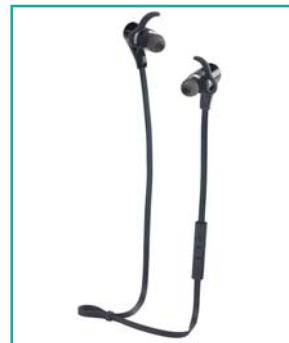

### YBT-100S

High-fidelity Bluetooth stereo headphones  
Comes with carrying case

Code : H10304      35€ incl. VAT



Headphones for smartphone, tablet or laptop  
Driver diameter: 38 mm  
Impedance: 64 Ω  
Sensitivity: 98 dB  
Frequency response: 10 - 20 kHz  
Cable: with integrated microphone and computer adapter  
Weight: 160 g

Fuschia pink colour

Headphones for smartphone, tablet or laptop  
Driver diameter: 38 mm  
Impedance: 64 Ω  
Sensitivity: 98 dB  
Frequency response: 10 - 20 kHz  
Cable: with integrated microphone and computer adapter  
Weight: 160 g

White colour

Compatible with all Bluetooth® devices  
Bluetooth® 4.0 Class 2  
Supported Bluetooth protocols: V4.0 CSR HFP, A2DP, AVRCP, vocal aids  
Communication distance: Up to 10 meters -  
Average battery life: 8 hours music playback  
IPX5 (sweat and rain resistant)  
Battery: Lithium 85mAh  
Output level: 100dB max.  
Frequency response: 20Hz-20KHz  
Signal to noise ratio: >70dB  
Distortion: <0.1%  
Weight: 14 g

Comes with protection box, charging cable, ear-fit silicon tips

## ALWAYS BY YOUR SIDE

Our range of headphones covers all areas: Street, Studio, DJing or Audiophile. Whether you choose Bluetooth® or other headphones, sound excellence, fit and design remain the main focus of our creations. Our models are amongst the greatest references of the audio world, serving individuals and professionals alike.







# PORTABLE SOUND SYSTEMS

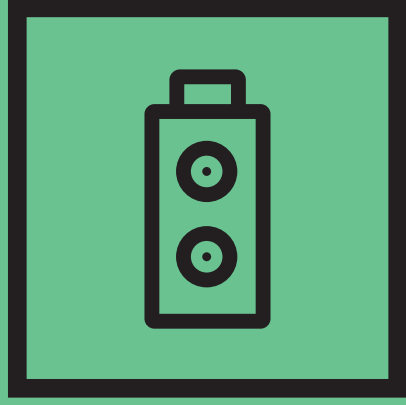

# PORTABLE SOUND SYSTEMS

Ultra mobility à la carte. Get out and about, and take your sound system with you wherever you go. From ultra-portable to ultra-powerful, from basic units to comprehensive sound systems, our extensive range covers all uses.

**NEW**



**CR25A-COMBO**  
Battery-powered portable sound system, 250 W RMS with BT, USB reader and two UHF microphones

Code : H10789      999€ incl. VAT



**CR12A-COMBO**  
Battery-powered portable sound system, 120 W RMS with BT, USB reader and two UHF microphones

Code : H10209      699€ incl. VAT



**CR120A-U1**  
Portable sound system, 120 W with BT, USB reader and one UHF microphone; supplied without battery

Code : H10285      599€ incl. VAT



**CR80A-COMBO**  
Battery-powered portable sound system, 80 W with BT, USB reader and one UHF microphone

Code : H10313      399€ incl. VAT



Power rating: 250 W [2 channels]  
Loudspeaker: 12" loudspeaker + 1.35" driver  
Microphones supplied : Two hand-held UHF microphones, 16 selectable frequencies  
**New 4G-compatible frequency ranges: UHF 823 to 832 MHz and 863 to 865 MHz**  
Free UHF microphone slot: No  
Source: USB/SD reader + Bluetooth®  
Free music player slot: No  
Inputs: Two LINE inputs on 3.5 mm stereo jack or RCA, two MIC/LINE inputs on combined XLR/Jack  
Echo chamber with adjustable delay  
Outputs: One LINE level on 6.35 mm TRS jack  
Battery: 2 x 18 V / 7 Ah NP  
Battery life: 5 hours (average)  
Weight: 24.5 kg  
Dimensions: 615 x 350 x 395mm  
Accessories supplied: Built-in trolley, infrared remote control

Options:  
COV-CR25A (protective cover)  
CR12A-HEADSET (pocket UHF transmitter and headset microphone)

Power rating: 120 W [2 channels]  
Loudspeaker: 10" loudspeaker + 1" driver  
Microphones supplied : Two hand-held UHF microphones, 16 selectable frequencies  
**New 4G-compatible frequency ranges: UHF 823 to 832 MHz and 863 to 865 MHz**  
Free UHF microphone slot: No  
Source: USB/SD reader + Bluetooth®  
Free music player slot: No  
Inputs: Two LINE inputs on 3.5 mm stereo jack or RCA, two MIC/LINE inputs on combined XLR/Jack  
Outputs: One LINE level on 6.35 mm TRS jack  
Battery: 2 x 12 V / 5 Ah NP  
Battery life: 6 hours (average)  
Weight: 17.3 kg  
Dimensions: 550 x 340 x 300 mm  
Accessories supplied: Built-in trolley, infrared remote control

Options:  
COV-CR12A (protective cover)  
CR12A-HEADSET (pocket UHF transmitter and headset microphone)

Power rating: 120 W [2 channels]  
Loudspeaker: 10" loudspeaker + 1" driver  
Microphone supplied: One hand-held UHF microphone, 16 selectable frequencies  
**New 4G-compatible frequency ranges: UHF 823 to 832 MHz and 863 to 865 MHz**  
Free UHF microphone slot: No  
Source: USB/SD reader + Bluetooth®  
Free music player slot: No  
Inputs: Two LINE inputs on 3.5 mm stereo jack or RCA, two MIC/LINE inputs on combined XLR/Jack  
Outputs: One LINE level on 6.35 mm TRS jack  
Battery: 2 x 12 V / 5 Ah NP (optional)  
Battery life: 6 hours (average)  
Weight: 16 kg without battery  
Dimensions: 550 x 340 x 300 mm  
Accessories supplied: Built-in trolley, infrared remote control

Options:  
COV-CR12A (protective cover)  
CR12A-HEADSET (pocket UHF transmitter and headset microphone)  
BATTERIES [Z08118 x 2]

Power rating: 80 W [2 channels]  
Loudspeaker: 6.5" loudspeaker + 1" driver  
Microphone supplied: 1 hand-held UHF microphone  
Fixed frequency: UHF range (863-865 MHz) - 10 mW  
Free UHF microphone slot: No  
Source: USB/SD reader + Bluetooth®  
Free music player slot: No  
Inputs: Two LINE inputs on 3.5 mm stereo jack or RCA, two MIC/LINE inputs on combined XLR/Jack  
Outputs: One LINE level on 6.35 mm TRS jack  
Battery: 2x DC 12 V 1.5 Ah Li-ion  
Battery life: 5 hours (average)  
Weight: 5.9 kg  
Dimensions: 375 x 240 x 210 mm  
Accessories supplied: Infrared remote control

Options:  
COV-CR80A (protective cover)

**NEW**



**COV-CR25A**  
Protective cover for CR25A-COMBO

Code : H10791      109€ incl. VAT



**COV-CR12A**  
Case for CR12A-COMBO loudspeaker

Code : H10208      99€ incl. VAT



**COV-CR80A**  
Case for CR80A-COMBO loudspeaker

Code : H10431      69€ incl. VAT



Rear view of CR12A-COMBO loudspeaker



### SPRINTER-One-V122

Battery-powered portable sound system, 120 W, without built-in sources

Code : H9977 729€ incl. VAT



### SPRINTER122

Battery-powered portable sound system, 120 W with BT, MP3 CD/USB/SD reader and one UHF microphone

Code : H9837 1099€ incl. VAT



### CROSSER180

Battery-powered portable sound system, 180 W with BT, MP3 CD/USB/SD reader and one UHF microphone

Code : H9895 1699€ incl. VAT



### CROSSER-One-V180

Battery-powered portable sound system, 120 W, without built-in sources

Code : H9978 1299€ incl. VAT



Power rating: 120 W (2 channels)  
Loudspeaker: 10" loudspeaker + 1" driver  
Free UHF microphone slot: 2  
Free music player slot: One CD-RUN or USB-RUN slot, one RUN-K7 slot  
Inputs: Two LINE in, two MIC in  
Outputs: One MIX out, one speaker out  
Battery: 2x 12 V / 4,5 Ah NP  
Battery life: 6 hours (average)  
Weight: 14 kg  
Dimensions: 500 x 320 x 290 mm  
Accessories supplied: Transport cover, built-in trolley, battery charger

Options: CD/USB/SD/MP3 reader + Bluetooth® + pitch and remote control, USB MP3 reader  
Additional microphone receiver, additional hand-held UHF microphone, additional headset UHF microphone, cassette module

Recommended passive loudspeaker: PASSSPRINT

Power rating: 120 W (2 channels)  
Loudspeaker: 10" loudspeaker + 1" driver  
Microphone supplied: One hand-held UHF microphone, 16 selectable frequencies  
**New 4G-compatible frequency ranges: UHF 823 to 832 MHz and 863 to 865 MHz**  
Free UHF microphone slot: 1  
Source: CD/USB/SD/MP3 reader + pitch + Bluetooth®  
Free music player slot: No  
Inputs: Two LINE in, two MIC in  
Outputs: One MIX out, one speaker out  
Battery: 2x 12 V / 4,5 Ah NP  
Battery life: 6 hours (average)  
Weight: 15 kg  
Dimensions: 500 x 320 x 290 mm  
Accessories supplied: Transport cover, built-in trolley, battery charger, infrared remote control

Options: Additional UHF receiver, additional hand-held UHF microphone, additional headset UHF microphone, cassette module

Recommended passive loudspeaker: PASSSPRINT

Power rating: 180 W (2 channels)  
Loudspeaker: 10" loudspeaker + 1.5" driver  
Microphone supplied: One hand-held UHF microphone, 16 selectable frequencies  
**New 4G-compatible frequency ranges: UHF 823 to 832 MHz and 863 to 865 MHz**  
Free UHF microphone slot: 1  
Source: CD/USB/SD/MP3 reader + pitch + Bluetooth®  
Free music player slot: No  
Inputs: Two LINE in, two MIC in  
Outputs: One MIX out, one speaker out  
Battery: 2 x 12 V / 5 Ah NP  
Battery life: 7 hours (average)  
Weight: 17 kg  
Dimensions: 500 x 320 x 360 mm  
Accessories supplied: Transport cover, built-in trolley, battery charger, infrared remote control

Options: Additional UHF receiver, additional hand-held UHF microphone, additional headset UHF microphone

Recommended passive loudspeaker: PASSCROSS

Power rating: 180 W (2 channels)  
Loudspeaker: 10" loudspeaker + 1.5" driver  
Free UHF microphone slot: 2  
Free music player slot: One CD-RUN or USB-RUN slot  
Inputs: Two LINE in, two MIC in  
Outputs: One MIX out, one speaker out  
Battery: 2 x 12 V / 5 Ah NP  
Battery life: 7 hours (average)  
Weight: 16 kg  
Dimensions: 500 x 320 x 360 mm  
Accessories supplied: Transport cover, built-in trolley, battery charger

Options: CD/USB/SD/MP3 reader + Bluetooth® + pitch and infrared remote control  
Additional microphone receiver, additional hand-held UHF microphone, headset UHF microphone

Recommended passive loudspeaker: PASSCROSS



### CR80-HEADSET

Transmitter + headset microphone for CR80A-COMBO

Code : H10534 69€ incl. VAT



### CR-12AHEADset

Transmitter + headset microphone for CR12A-COMBO

Code : H10210 99€ incl. VAT



### COV-CROSS

Transport cover for CROSSER loudspeakers

Code : H9985 39€ incl. VAT



### COV-SPRINT

Transport cover for SPRINTER loudspeakers

Code : H9986 35€ incl. VAT



Compatible with the CR80A-COMBO portable sound system  
Fixed frequency: UHF range (863-865 MHz) - 10 mW  
Type: Cardioid condenser microphone  
Frequency response: 70 - 18 kHz

Compatible with the CR12A-COMBO portable sound system  
16 selectable frequencies (823-832 and 863-865 MHz) - 10 mW  
Type: Cardioid condenser microphone  
Frequency response: 70 - 18 kHz

# PORTABLE SOUND SYSTEMS



## JOGGER60

Battery-powered portable sound system, 60 W, with USB/SD reader, one UHF microphone and one wired microphone

Code : H9894

549€ incl. VAT



## JOGGER50

Battery-powered portable sound system, 50 W, with USB reader, one hand-held UHF microphone and carrying bag

Code : H9587

449€ incl. VAT



## LTPOW

External charger for 260 mA lithium batteries, for JOGGER systems

Code : H9591

79€ incl. VAT



## LT2600

260 mA lithium battery for JOGGER systems

Code : H9592

79€ incl. VAT



Power rating: 60 W (2-way)  
Loudspeaker: 5" loudspeaker + 1" driver  
Microphones supplied: One wired microphone and one hand-held UHF microphone, 16 selectable frequencies  
**New 4G-compatible frequency ranges: UHF 823 to 832 MHz and 863 to 865 MHz**  
Source: USB/SD/MP3 reader  
Inputs: One LINE input on 3.5 mm stereo jack, one MIC input on 6.35 mm jack  
Outputs: One Mix output, LINE level, on 3.5 mm jack  
Battery: 1x Lithium 14.4 V 2.6 Ah  
Battery life: 4 hours (average)  
Weight: 2.9 kg  
Dimensions: 290 x 160 x 210 mm  
Accessories supplied: carrying bag, lithium battery, mains adapter, infrared remote control

Options: Additional battery, external battery charger

Power rating: 50 W  
Loudspeaker: 5" speaker  
Microphones supplied: One wired microphone and one hand-held UHF microphone, 16 selectable frequencies  
**New 4G-compatible frequency ranges: UHF 823 to 832 MHz and 863 to 865 MHz**  
Source: USB/MP3 reader  
Inputs: One LINE input on 3.5 mm stereo jack, one MIC input on 6.35 mm jack  
Outputs: One Mix output, LINE level, on 3.5 mm jack  
Battery: 1x Lithium 14.4 V 2.6 Ah  
Battery life: 4 hours (average)  
Weight: 2.2 kg  
Dimensions: 290 x 160 x 210 mm  
Accessories supplied: carrying bag, lithium battery, mains adapter

Options: Additional battery, external battery charger



JOGGER60 in carrying bag supplied, with remote control and hand-held microphone included



## PASSPRINT

120 W passive loudspeaker The ideal match for the SPRINTER

Code : H9983

329€ incl. VAT



## PASSCROSS

180 W passive loudspeaker The ideal match for the CROSSER

Code : H9984

449€ incl. VAT



Power rating: 120 W (2-way)  
Loudspeaker: 10" loudspeaker + 1" driver  
Supplied with a protective cover

Power rating: 180 W (2-way)  
Loudspeaker: 10" loudspeaker + 1.5" driver  
Supplied with a protective cover



### RECEPT-MOD16

Slot-in UHF receiver module

Code : H9979 109€ incl. VAT



Slot-in UHF receiver in for EMEA-HAND and EMEA-HEAD  
16 selectable frequencies (823-832 and 863-865 MHz) - 10 mW  
Compatible with RUNNER, SPRINTER and CROSSER



### EMET-HAND

Hand-held microphone UHF transmitter

Code : H9980 119€ incl. VAT



Dynamic hand-held UHF microphone  
16 selectable frequencies (823-832 and 863-865 MHz) - 10 mW  
Uses two 1.5 V AA batteries (not supplied)  
Compatible with RUNNER, SPRINTER, CROSSER and JOGGER



### EMET-HEAD

Headset microphone with Pocket UHF transmitter

Code : H9981 139€ incl. VAT



Unidirectional headset condenser microphone + pocket UHF transmitter  
16 selectable frequencies (823-832 and 863-865 MHz) - 10 mW  
Uses two 1.5 V AA batteries (not supplied)  
Compatible with RUNNER, SPRINTER, CROSSER and JOGGER



### USB-RUN

USB reader for double slot

Code : H9982 69€ incl. VAT



Reads MP3 and WMA files  
Compatible with RUNNER, SPRINTER and CROSSER



### CD-RUN BT

CD/USB/SD and Bluetooth module

Code : H10184 279€ incl. VAT



CD, USB flash drive and SD card reader  
Bluetooth® V2.0 AVRCP  
Reads MP3 and WMA files  
Infrared remote control  
Compatible with RUNNER, SPRINTER and CROSSER



### RUN-K7

Cassette player/recorder module for SPRINTER only

Code : H8206 129€ incl. VAT



Player with logic controls  
Autoreverse play and recording  
Adjustable pitch  
Digital counter for locating recordings

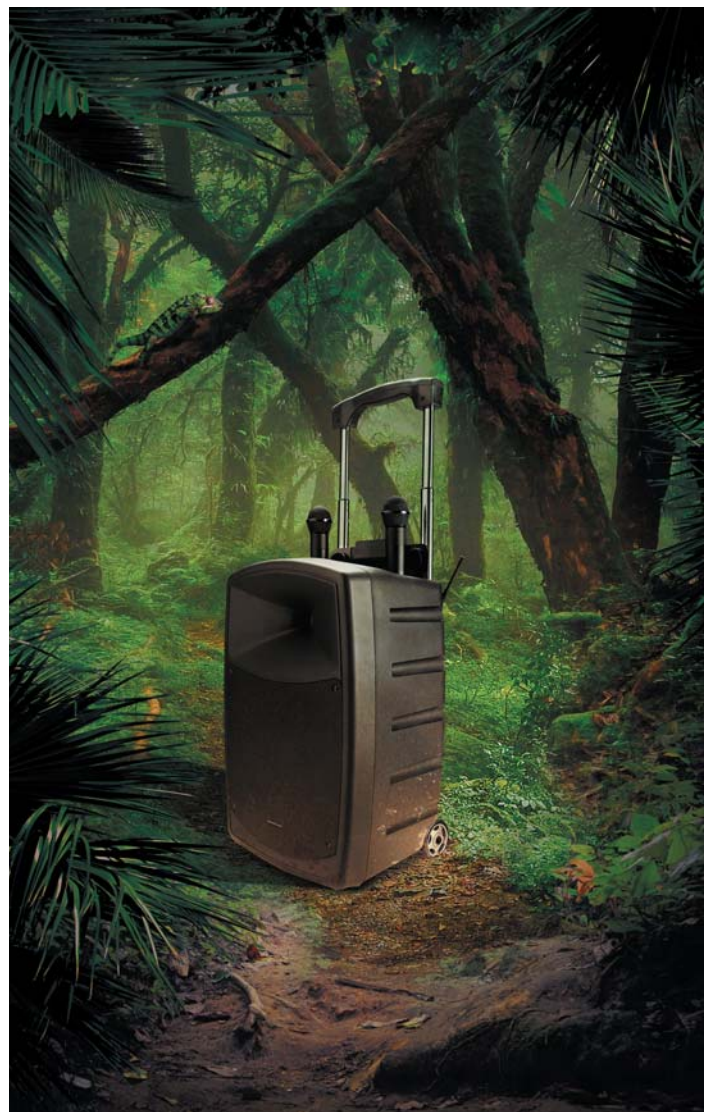

# PORTABLE SOUND SYSTEMS



## PPA-101

Portable sound system, 50 W, with BT, FM, USB/SD reader and two UHF microphones; supplied without battery

Code : B00195 409€ incl. VAT



## Hand-held UHF microphone for PPA-101 (863.35 MHz)

Code : B00197 54,90€ incl. VAT



## Battery for PPA-101

12 V, 7 Ah lead-acid battery

Code : B00198 32,90€ incl. VAT



Power rating: 50 W (2-way)  
Loudspeaker: 10" loudspeaker + 1" driver  
Microphone supplied: One hand-held UHF microphone (863.35 MHz) + one headset microphone with Pocket UHF transmitter (864.80MHz)  
Source: USB/SD reader + Bluetooth® + FM tuner  
Inputs: One LINE input on 3.5 mm stereo jack, RCA or XLR, one MIC input on combined XLR/jack  
Outputs: 1 LINE level on XLR  
Battery: 1x 12 V 7 Ah (optional - code B00198)  
Battery life: 6 hours (average)  
Weight: 15.5 kg without battery  
Dimensions: 550 x 325 x 280 mm  
Accessories supplied: Built-in trolley, 12V car power cable

Options:  
TOURING BAG-PPA-101 (protective cover)



## TOURING BAG - PPA-101

Protective bag for PPA-101

Code : B00598 39€ incl. VAT



## PPA-121

Powerful professional portable speaker with USB/SD reader, FM, one LINE and two MIC inputs

Code : B00191 239€ incl. VAT



Power rating: 250 W (2-way)  
Loudspeaker: 12" loudspeaker + 1.35" driver  
Microphone supplied: No  
Source: USB/SDHC reader + FM tuner  
Inputs: One LINE input on RCA/XLR, two MIC inputs on XLR/jack  
Outputs: 1 LINE level on XL  
Battery: No  
Weight: 15 kg  
Dimensions: 580 x 372 x 315 mm  
Accessories included: Infrared remote control



### BOOMBOX

60 W battery-powered BT speaker with FM, IPX4

Code : H10483

209€ incl. VAT



### COV-BOOMBOX

Transport cover for BOOMBOX

Code : H10488

49€ incl. VAT



### Brick120

Bluetooth HiFi speaker, IPX5

Code : H10216

99€ incl. VAT



### Bora Bora

60 W portable outdoor speaker, IPX5

Code : H10174

249€ incl. VAT



Power rating: 60 W (2-way)  
 Loudspeaker: 6.5" speaker + 1.5" tweeter  
 Microphone supplied: No  
 Source: Bluetooth/FM tuner/USB  
 Inputs: One LINE input on 3.5 mm stereo jack, one MIC input on 6.35 mm jack, one MIC/guitar input on 6.35 mm jack  
 Outputs: USB 5 V 1 A for smartphone charging  
 Battery: 1x 4000 mAh lithium battery  
 Battery life: 10 hours (average)  
 Weight: 6 kg  
 Dimensions: 340 x 230 x 460 mm  
 Ingress protection: IPX4 (humidity-resistant)

Accessories included: Built-in trolley

Options:

**COV-BOOMBOX** (Carrying bag)

Power rating: 20 W (2-way)  
 Bluetooth V4.0 AVRCP, CSR compression, APT-X, NFC pairing  
 Average operating range 10 metres - Bluetooth Class 2  
 Controls on top: ON/OFF, BT volume, play-pause, skip and search, battery level display  
 Input: One LINE input on 3.5 mm stereo jack  
 Battery life approx. 10 hours  
 Weight: 650 g  
 Battery: Lithium  
 Dimensions: 180 x 80 x 80 mm  
 Ingress protection: IPX5 (weather-resistant)  
 Accessory supplied: mains battery charger

Power rating: 60 W (2-way)  
 Loudspeaker: One 5.25" speaker + four 2" speakers  
 Bluetooth V4.0 AVRCP, CSR compression, APT-X, NFC pairing  
 Inputs: One LINE input on 3.5 mm stereo jack  
 Controls on top: Standby, Volume + and -, battery level display  
 Battery: 1x Lithium 14.8 V 2600 mA  
 Battery life: 8 hours (average)  
 Weight: 2.9 kg  
 Dimensions: Diameter 195 / Height 370 mm  
 Ingress protection: IPX5 (weather-resistant)  
 Accessories supplied: mains battery charger, 3.5 mm jack/3.5 mm jack stereo lead



Compatible with smartphones, tablets or other Bluetooth® transmitters, the BoraBora speaker is very easy to connect and offers large freedom of movement. It is NFC-compatible: simply bring up your device to pair. It features an AUX input for broadcasting sound from non-Bluetooth® sources.

#### 8 HOURS WITH NO WORRIES

BoraBora can run for 8 hours on battery power, for a charging time of only 2 hours, and can of course be used on mains power via the supplied adapter.

#### ENJOY THE OPEN AIR

Weather-resistant, with sufficient power for outdoor use, the BoraBora speaker features 360° playback to ensure that it is always at the centre of your activities.







# COMMERCIAL AUDIO

BROADCASTING  
AMPLIFIERS  
MULTI SOURCE PLAYERS  
HEARING LOOP SYSTEMS

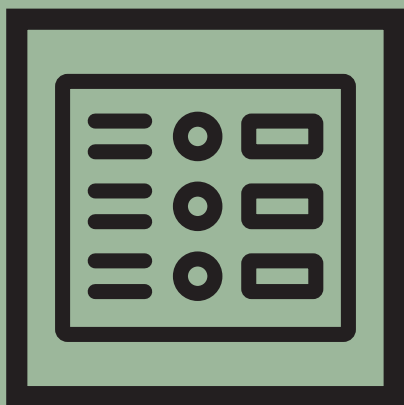

# BROADCASTING

## The time of the austere public address is over.

The name "Commercial Audio" is becoming more important for AUDIOPHONY PA.

Nowadays, these ranges are installed for their sound quality in chic and trendy places, but also in domestic settings. Their faithful reproduction of sound is one of the most important points, combined with aesthetics and simplicity.

## AUDIOPHONY PA Commercial Audio, of course.

With the "Commercial Audio" range, you have a commercial broadcasting medium in shops, bars, public areas, etc.

Good sound quality is a distinct advantage. This is without mentioning our know-how in professional and institutional areas, with a range of easy-to-use products, capable of easing all your indoor, as well as outdoor, constraints.



**NEW**



**SpeakUP**  
Active lectern 40 W + MP3 / record + HF microphone

Code : H10830      749€ incl. VAT



Amplified column lectern with VHF mic.  
Built-in amplifier 40 W RMS.  
Comes with 1 gooseneck microphone and 1 VHF hand-held microphone with in-built receiver.  
1 MP3 reader/recorder module:  
USB/SD/MMC  
1 XLR microphone input.  
1 RCA auxiliary input.  
3 full-range loudspeakers.  
Frequency response: 100 Hz – 16 kHz  
1 recording output or 0dB line (6.35 mm jack).  
Power: 240 V 50/60 Hz  
Dimensions: 1140 x 580 x 420 mm  
Weight: 17.2 kg



**Borneo660b**  
Tropicalised installation speaker 60 Watts  
2-way - 8 Ohms/100 V - Black

Code : H9920      229€ incl. VAT



Power rating: 60 W RMS  
Available power:  
60 W/20 W/15 W/10 W/5 W  
8 Ohms/100 V  
Tweeter: 1 inch  
Woofers: 6.5 inch  
Frequency response: 45 Hz – 20 kHz  
Sensitivity (1 W @ 1 m): 89 dB  
Attachment: swivel bracket  
Humidity-resistant tropicalised speaker.  
Dimensions: 340 x 220 x 200 mm  
Net weight: 3.8 kg  
Unit price – Sold by 2pcs



**Borneo660w**  
Tropicalised installation speaker 60 Watts  
2-way - 8 Ohms/100 V - White

Code : H9911      229€ incl. VAT



Power rating: 60 W RMS  
Available power:  
60 W/20 W/15 W/10 W/5 W  
8 Ohms/100 V  
Tweeter: 1 inch  
Woofers: 6.5 inch  
Frequency response: 45 Hz – 20 kHz  
Sensitivity (1 W @ 1 m): 89 dB  
Attachment: swivel bracket  
Humidity-resistant tropicalised speaker.  
Dimensions: 340 x 220 x 200 mm  
Net weight: 3.8 kg  
Unit price – Sold by 2pcs



### EHP880B

Installation speaker 80 Watts  
2-way - 8 Ohms/70 V/100 V - Black

Code : H10212 139€ incl. VAT



### EHP880W

Installation speaker 80 Watts  
2-way - 8 Ohms/70 V/100 V - White

Code : H10213 139€ incl. VAT



### EHP520b

Installation speaker 40 Watts  
2-way - 8 Ohms/70 V/100 V - Black

Code : H9763 79€ incl. VAT



### EHP520w

Installation speaker 40 Watts  
2-way - 8 Ohms/70 V/100 V - White

Code : H9762 79€ incl. VAT



Power rating: 80 W RMS  
Available power: 80 W/40 W/20 W at 100 V - 40 W/20 W/10 W at 70 V  
80 W at 8 Ohms  
Tweeter: 1 inch  
Woofer: 8 inch  
Frequency response: 70 Hz - 18 kHz  
Sensitivity (1 W @ 1 m): 92 dB  
Attachment: swivel bracket  
Dimensions: 410 x 290 x 240 mm  
Net weight: 8 kg  
Unit price - Sold by 2pcs

Power rating: 80 W RMS  
Available power: 80 W/40 W/20 W at 100 V - 40 W/20 W/10 W at 70 V  
80 W at 8 Ohms  
Tweeter: 1 inch  
Woofer: 8 inch  
Frequency response: 70 Hz - 18 kHz  
Sensitivity (1 W @ 1 m): 92 dB  
Attachment: swivel bracket  
Dimensions: 410 x 290 x 240 mm  
Net weight: 8 kg  
Unit price - Sold by 2pcs

Power rating: 40 W RMS  
Available power: 40 W/20 W/10 W at 100 V - 20 W/10 W/5 W at 70 V  
40 W at 8 Ohms  
Tweeter: 1 inch  
Woofer: 5 inch  
Frequency response: 80 Hz - 18 kHz  
Sensitivity (1 W @ 1 m): 89 dB  
Attachment: swivel bracket  
Dimensions: 270 x 187 x 165 mm  
Net weight: 3.4 kg  
Unit price - Sold by 2pcs

Power rating: 40 W RMS  
Available power: 40 W/20 W/10 W at 100 V - 20 W/10 W/5 W at 70 V  
40 W at 8 Ohms  
Tweeter: 1 inch  
Woofer: 5 inch  
Frequency response: 80 Hz - 18 kHz  
Sensitivity (1 W @ 1 m): 89 dB  
Attachment: swivel bracket  
Dimensions: 270 x 187 x 165 mm  
Net weight: 3.4 kg  
Unit price - Sold by 2pcs



### EHP410b

Installation speaker 20 Watts  
2-way - 8 Ohms/70V/100V - Black

Code : H9761 69€ incl. VAT



### EHP410w

Installation speaker 20 Watts  
2-way - 8 Ohms/70 V/100 V - White

Code : H9760 69€ incl. VAT



### ROT45b

Black swivel ball mount for speakers  
EHP410b and EHP520b - 1 piece

Code : H9824 12€ incl. VAT



### ROT45w

White swivel ball mount for speakers  
EHP410w and EHP520w - 1 piece

Code : H9825 12€ incl. VAT



Power rating: 20 W RMS  
Available power: 20 W/10 W/5 W at 100 V - 10 W/5 W/2.5 W at 70 V  
20 W at 8 Ohms  
Tweeter: 1 inch  
Woofer: 4 inch  
Frequency response: 80 Hz - 18 kHz  
Sensitivity (1 W @ 1 m): 89 dB  
Attachment: swivel bracket  
Dimensions: 240 x 170 x 160 mm  
Net weight: 1.45 kg  
Unit price - Sold by 2pcs

Power rating: 20 W RMS  
Available power: 20 W/10 W/5 W at 100 V - 10 W/5 W/2.5 W at 70 V  
20 W at 8 Ohms  
Tweeter: 1 inch  
Woofer: 4 inch  
Frequency response: 80 Hz - 18 kHz  
Sensitivity (1 W @ 1 m): 89 dB  
Attachment: swivel bracket  
Dimensions: 240 x 170 x 160 mm  
Net weight: 1.45 kg  
Unit price - Sold by 2pcs

# BROADCASTING



**K-50/Black (pair)**  
Installation speaker 50 Watts  
2-way - 8 Ohms - Black

---

Code : B00668      84,90€ incl. VAT

---



Power rating: 50 W RMS  
Available power:  
50 W at 8 Ohms  
Tweeter: 1 inch  
Woofer: 5.25 inch  
Frequency response: 55 Hz - 20 kHz  
Attachment: swivel bracket  
Dimensions: 238 x 180 x 150 mm  
Net weight: 5 kg  
Price for the pair



**K-50/White (pair)**  
Installation speaker 50 Watts  
2-way - 8 Ohms - White

---

Code : B00669      84,90€ incl. VAT

---



Power rating: 50 W RMS  
Available power:  
50 W at 8 Ohms  
Tweeter: 1 inch  
Woofer: 5.25 inch  
Frequency response: 55 Hz - 20 kHz  
Attachment: swivel bracket  
Dimensions: 238 x 180 x 150 mm  
Net weight: 5 kg  
Price for the pair



**K-30/Black (pair)**  
Installation speaker 40 Watts  
2-way - 8 Ohms - Black

---

Code : B00672      49€ incl. VAT

---



Power rating: 40 W RMS  
Available power:  
40 W at 8 Ohms  
Tweeter: 1 inch  
Woofer: 3.5 inch  
Frequency response: 65 Hz - 20 kHz  
Attachment: swivel bracket  
Dimensions: 170 x 130 x 105 mm  
Net weight: 2.5 kg  
Price for the pair



**K-30/White (pair)**  
Installation speaker 40 Watts  
2-way - 8 Ohms - White

---

Code : B00673      49€ incl. VAT

---



Power rating: 40 W RMS  
Available power:  
40 W at 8 Ohms  
Tweeter: 1 inch  
Woofer: 3.5 inch  
Frequency response: 65 Hz - 20 kHz  
Attachment: swivel bracket  
Dimensions: 170 x 130 x 105 mm  
Net weight: 2.5 kg  
Price for the pair



**K-80/Black (pair)**  
Installation speaker 85 Watts  
2-way - 8 Ohms - Black

---

Code : B00670      169€ incl. VAT

---



Power rating: 85 W RMS  
Available power:  
85 W at 8 Ohms  
Tweeter: 1 inch  
Woofer: 8 inch  
Frequency response: 35 Hz - 20 kHz  
Attachment: swivel bracket  
Dimensions: 335 x 270 x 210 mm  
Net weight: 12.8 kg  
Price for the pair



**K-80/White (pair)**  
Installation speaker 85 Watts  
2-way - 8 Ohms - White

---

Code : B00671      169€ incl. VAT

---



Power rating: 85 W RMS  
Available power:  
85 W at 8 Ohms  
Tweeter: 1 inch  
Woofer: 8 inch  
Frequency response: 35 Hz - 20 kHz  
Attachment: swivel bracket  
Dimensions: 335 x 270 x 210 mm  
Net weight: 12.8 kg  
Price for the pair



**OHO-350b (pair)**  
Spherical satellite speaker 50 W RMS  
2-way - Black

---

Code : H10125      199€ incl. VAT

---



Power rating: 50 W RMS  
Frequency response: 100 Hz - 25 KHz  
Sensitivity (1 W @ 1 m): 89 dB  
Nominal impedance: 8 Ohms  
Tweeter: 1 inch  
Woofer: 3 inch  
Connector: Terminal block integrated in the magneticbracke  
Dimensions: 99 mm diameter  
Weight: 0.7 kg  
Price for the pair



**OHO-350w (pair)**  
Spherical satellite speaker 50 W RMS  
2-way - White

---

Code : H10124      199€ incl. VAT

---



Power rating: 50 W RMS  
Frequency response: 100 Hz - 25 KHz  
Sensitivity (1 W @ 1 m): 89 dB  
Nominal impedance: 8 Ohms  
Tweeter: 1 inch  
Woofer: 3 inch  
Connector: Terminal block integrated in the magneticbracke  
Dimensions: 99 mm diameter  
Weight: 0.7 kg  
Price for the pair



**MIO-Sat440b (pair)**

Wall speaker on adjustable mount  
2-way - 8 Ohms - 40 W

Code : H10154 189€ incl. VAT



Power rating: 40 W RMS  
Frequency response: 120 Hz - 16 KHz  
Maximum SPL (@ 1 m): 116 dB  
Nominal impedance: 8 Ohms  
Tweeter: 1 inch  
Woofer: 4 inch  
Connector: Terminal block at rear  
Dimensions: 225 x 150 x 170 mm  
Weight: 2.6 kg  
Price for the pair



**MIO-Sat225b (pair)**

Wall speaker on adjustable mount, Hi-Fi  
speaker - 8 Ohms - 25 W

Code : H10150 69€ incl. VAT



Power rating: 25 W RMS  
Frequency response: 200 Hz - 15 KHz  
Maximum SPL (@ 1 m): 110 dB  
Nominal impedance: 8 Ohms  
Speaker: 2 x 2.75 inches  
Connector: Terminal block integrated  
in bracket  
Dimensions: 90 x 136 x 180 mm  
Weight: 0.950 kg  
Price for the pair



**MIO-Sub8150b**

Active sub with active satellite output  
150 W + 2 x 40 W

Code : H10153 349€ incl. VAT



ACTIVE SUB:  
Power rating: 150 W  
Frequency response: 52 - 200 Hz  
Maximum SPL (@ 1 m): 120 dB  
Woofer: 8 inch  
Dimensions: 360 x 250 x 250 mm  
Weight: 10.3 kg  
AMPLIFICATION:  
Low level: 1 x 150 W  
Mid/high level: 2 x 40 W RMS / 4 Ohms  
Sub phase switch 0/180  
Sub and Master adjustable levels.  
Connectors: 2 x XLR/Jack Combo and  
2 x RCA line input  
Terminal block for satellites



**MIO-Sub6100b**

Active sub with active satellite output  
100 W + 2 x 25 W

Code : H10149 199€ incl. VAT



ACTIVE SUB:  
Power rating: 100 W  
Frequency response: 50 - 200 Hz  
Maximum SPL (@ 1 m): 112 dB  
Woofer: 6.5 inch  
Dimensions: 320 x 240 x 200 mm  
Weight: 8.5 kg  
AMPLIFICATION:  
Low level: 1 x 100 W  
Mid/high level: 2 x 25 W RMS / 4 Ohms  
Sub phase switch 0/180  
Sub and Master adjustable levels.  
Connectors: 2 x XLR/Jack Combo and  
2 x RCA line input  
Terminal block for satellites



**OH0-Systema1b**

Amplified triphonic system 150 W lows -  
2 x 40 W highs

Code : H10156 499€ incl. VAT



This amplified triphonic system is  
consists of:  
1 x MIO-Sub8150b  
2 x OH0-350b



**MIO-Systema2b**

Amplified triphonic system 150 W lows -  
2 x 40 W highs

Code : H10152 529€ incl. VAT



This amplified triphonic system is  
consists of:  
1 x MIO-Sub8150b  
2 x MIO-Sat440b



**MIO-Systema1b**

Amplified triphonic system 100 W lows -  
2 x 25 W highs

Code : H10148 259€ incl. VAT



This amplified triphonic system is  
consists of:  
1 x MIO-Sub6100b  
2 x MIO-Sat225b



Rear view of MIO-Sub8150b



# BROADCASTING



## CHF860

Hi-Fi ceiling recessed speaker 60 Watts  
2-way - 8 Ohms

Code : H9909 139€ incl. VAT



2-way speaker  
Power rating: 60 W RMS  
Available power: 60 W at 8 Ohms  
Impedance: 8 Ohms  
Tweeter: 1 inch  
Woofer: 6.5 inch  
Frequency response: 40 Hz - 20 kHz  
Sensitivity >90dB  
External dimensions (diameter and depth):  
280 x 180 mm  
Drilling diameter: 247 mm  
Net weight: 2.48 kg



## CHP660

Ceiling recessed speaker  
2-way - 60 W / 8 Ohms - 10 W / 100 V

Code : H9910 119€ incl. VAT



Power rating: 60 W RMS  
Available power:  
60 W at 8 Ohms  
10 W / 5 W / 2.5 W / 1.25 W at 100 V  
Tweeter: 1 inch  
Woofer: 6.5 inch  
Frequency response: 56 Hz - 20 kHz  
Sensitivity (1 W @ 1 m): 90 dB  
External dimensions (diameter and depth):  
240 x 140 mm  
Drilling diameter: 208 mm  
Net weight: 1.75 kg



## CHP620

Ceiling recessed speaker  
2-way 20 W / 100 V

Code : H9757 59€ incl. VAT



Power rating: 20 W RMS  
Available power:  
20 W / 10 W at 100 V  
Tweeter: 1.5 inch  
Woofer: 6.5 inch  
Frequency response: 85 Hz - 18 kHz  
Sensitivity (1 W @ 1 m): 98 dB  
External dimensions (diameter and depth):  
233 x 118 mm  
Drilling diameter: 200 mm  
Net weight: 1.7 kg



## CHP610

Ceiling recessed speaker  
2-way 10 W / 100 V

Code : H9756 49€ incl. VAT



Power rating: 10 W RMS  
Available power:  
10 W / 5 W / 2.5 W at 100 V  
Tweeter: 1.5 inch  
Woofer: 6.5 inch  
Frequency response: 56 Hz - 20 kHz  
Sensitivity (1 W @ 1 m): 93 dB  
External dimensions (diameter and depth):  
230 x 90 mm  
Drilling diameter: 200 mm  
Net weight: 1.4 kg



## CHP606

Ceiling recessed double cone speaker  
6 W / 100 V

Code : H9755 25€ incl. VAT



Power rating: 6 W RMS  
Available power:  
6 W / 3 W at 100 V  
Speaker: double cone 6.5 inches  
Frequency response: 110 Hz - 13 kHz  
Sensitivity (1 W @ 1 m): 90 dB  
External dimensions (diameter and depth):  
230 x 90 mm  
Drilling diameter: 200 mm  
Net weight: 0.9 kg



## CHPsub

Ceiling recessed subwoofer  
60 W / 8 Ohms - 60 W / 100 V

Code : H10533 219€ incl. VAT



Power rating: 60 W RMS  
Available power:  
60 W at 8 Ohms  
60 W / 40 W / 20 W at 100 V  
Frequency response: 80 Hz - 200 Hz  
Woofer: 8 inch  
Sensitivity (1 W @ 1 m): 95 dB  
Enclosed metal box  
Integrated passive filter  
External dimensions (diameter and depth):  
295 x 215 mm  
Drilling diameter: 265 mm  
Net weight: 5 kg



The two-way coaxial system fitted to the CHP620 and CHP610 ceiling speakers makes it possible to reproduce any type of music with great clarity, even at a low volume.

The presence of the tweeter is a guarantee of voice reproduction quality, and of its perfect intelligibility.



### SHP510

Suspended aluminium speaker IP55  
10 W / 100 V

Code : H9758 69€ incl. VAT



Power rating: 10 W RMS  
Available power:  
10 W / 5 W / 2.5 W at 100 V  
Frequency response: 150 Hz – 15 kHz  
Speaker: 5 inch  
Sensitivity (1 W @ 1 m): 90 dB  
White aluminium body,  
Ingress protection: IP55 (weather-resistant)  
Dimensions (Ø x D): 138 x 205 mm  
Weight: 2.2 kg



### PHP510

Aluminium sound projector IP55  
10 W / 100 V

Code : H9759 69€ incl. VAT



Power rating: 10 W RMS  
Available power:  
10 W / 5 W / 2.5 W at 100 V  
Frequency response: 150 Hz – 14 kHz  
Speaker: 5 inch  
Sensitivity (1 W @ 1 m): 90 dB  
White aluminium body,  
Ingress protection: IP55 (weather-resistant)  
Dimensions (Ø x D): 138 x 205 mm  
Weight: 2.1 kg



### PHP650

Sound projector IP55  
50 W / 100 V

Code : H10211 219€ incl. VAT



Power rating: 50 W RMS  
Available power:  
50 W/25/12.5/9/4.5/2.6 at 100 V  
Frequency response: 90 Hz – 20 kHz  
Speaker: 6.5 inches and 1-inch  
compression  
Sensitivity (1 W @ 1 m): 99 dB  
ABS body,  
Ingress protection: IP55 (weather-resistant)  
Dimensions: 363 x 253 x 310 mm  
Weight: 3.9 kg



### CLS220

2-speakers column  
100 V - 10/20 W

Code : H10514 69€ incl. VAT



Power rating: 20 W RMS  
Available power:  
20 W / 10 W at 100 V  
Speaker: 2 x 2.5 inches  
Frequency response: 250 Hz -15 KHz  
Sensitivity (1 W @ 1 m): 94 dB  
Aluminium body and grill,  
Ingress protection: IP44 (weather-resistant)  
Dimensions: 104 x 73 x 262 mm  
Weight: 1.4 kg



### CLS440

4-speakers column  
100 V - 20/40 W

Code : H10515 79€ incl. VAT



Power rating: 40 W RMS  
Available power:  
40 W / 20 W at 100 V  
Speaker: 4 x 2.5 inches  
Frequency response: 250 Hz -15 KHz  
Sensitivity (1 W @ 1 m): 95 dB  
Aluminium body and grill,  
Ingress protection: IP44 (weather-resistant)  
Dimensions: 104 x 73 x 402 mm  
Weight: 1.94 kg



### CLS660

6-speakers column  
100 V - 30/60 W

Code : H10516 99€ incl. VAT



Power rating: 60 W RMS  
Available power:  
60 W / 30 W at 100 V  
Speaker: 6 x 2.5 inches  
Frequency response: 250 Hz -15 KHz  
Sensitivity (1 W @ 1 m): 96 dB  
Aluminium body and grill,  
Ingress protection: IP44 (weather-resistant)  
Dimensions: 104 x 73 x 550 mm  
Weight: 2.6 kg

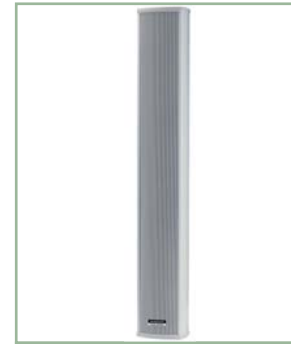

### CLS880

8-speakers column  
100 V - 40/80 W

Code : H10517 119€ incl. VAT



Power rating: 80 W RMS  
Available power:  
80 W / 40 W at 100 V  
Speaker: 8 x 2.5 inches  
Frequency response: 250 Hz -15 KHz  
Sensitivity (1 W @ 1 m): 97 dB  
Aluminium body and grill,  
Ingress protection: IP44 (weather-resistant)  
Dimensions: 104 x 73 x 690 mm  
Weight: 3.34 kg

# AMPLIFIERS



**WALLAMP60**  
Built-in stereo Hi-Fi amplifier 2 x 30 W  
2 line inputs

Code : H9908 159€ incl. VAT



Class-D amplifier  
2 x 30 W stereo at 8 Ohms  
A and B line inputs accessible at the front via 3.5 mm stereo jack  
A and B line inputs accessible at the back via terminal  
Input sensitivity: 280 mV  
Frequency response: 30 Hz – 20 kHz  
Power supply: DC24V included  
Casing box included  
Dimensions: 140 x 70 x 61 mm  
Net weight: 0.7 Kg



**WALLAMP-USB**  
Built-in stereo Hi-Fi amplifier 2 x 30 W  
2 line inputs, USB reader and IR remote control

Code : H10660 149€ incl. VAT



Class-D amplifier  
2 x 30 W stereo at 4 Ohms  
USB reader for MP3/WMA/WAV files  
Infrared remote control  
3-mode equaliser: speech, hall, music  
A and B line inputs accessible at the front via 3.5 mm stereo jack  
A and B line inputs accessible at the back via terminal  
Input sensitivity: 300 mV  
Frequency response: 20 Hz-20 kHz  
Power supply: DC19V included  
Dimensions: 50 x 50 x 29 mm  
Net weight: 0.11 Kg  
Compatible with PILOTBOX (H10637)  
casing box



**WALLAMP-USB PACK**  
Built-in Hi-Fi amplifier set

Code : H10659 279€ incl. VAT



Set composed of:  
1 x WALLAMP-USB  
Class-D amplifier  
2 x 30 W stereo at 4 Ohms  
USB reader + IR remote control  
2 line inputs  
  
2 x 2-way speakers with white finish  
Power rating: 50 W RMS  
Impedance: 4 Ohms  
Tweeter: 0.75 inch  
Woofer: 4 inch  
Frequency response: 80 Hz to 20 kHz  
Sensitivity (1 W @ 1 m): 88 dB  
ABS box, metal grill  
Swivel hook attachment  
Dimensions: 245 x 160 x 160 mm  
Net weight: 1.6 kg unit



Box casing  
**PILOTBOX**  
(code H10637)

Compatible with  
**WALLAMP-USB**



**AMP480**  
1-way public address amplifier  
1 x 480 W at 100 V

Code : H10512 549€ incl. VAT



1 mono input via Phoenix plug  
1 100V output via Phoenix plug  
1 line level link output via Phoenix plug  
Channel volume adjustment  
Flat/HPF channel switch  
Output level display via 4 LED VU meters  
Access to installer settings (via screwdriver)  
Power supply: 230 V 50/60 Hz  
Frequency response: 50 Hz - 15 kHz  
T.H.D (1 kHz nominal power): 0.1%  
Dimensions: 380 x 088 x 482 mm  
19-inch rackable, Height: 2 units  
Weight: 6.6 kg



- Very high power 480 W at 100 V
- Switched-mode power supply
- Settings accessible only at the back

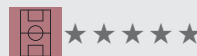





### AMP4120

4-way public address amplifier  
4 x 120 W at 100 V

Code : H10511 649€ incl. VAT



4 mono inputs via Phoenix plug  
4 100 V outputs via Phoenix plug  
4 line level link outputs via Phoenix plug  
Volume adjustment for each channel,  
Flat/HPF switch for each channel  
Output level display for each channel via  
4 LED VU meters  
Access to installer settings  
Power supply: 230 V 50/60 Hz  
Frequency response: 50 Hz - 15 kHz  
T.H.D (1 kHz nominal power): 0.1%  
Dimensions: 380 x 088 x 482 mm  
19-inch rackable, Height: 2 units  
Weight: 7.2kg

### AMP4240

4-way public address amplifier  
4 x 240 W at 100 V

Code : H10506 729€ incl. VAT



4 mono inputs via Phoenix plug  
4 100 V outputs via Phoenix plug  
4 line level link outputs via Phoenix plug  
Volume adjustment for each channel,  
Flat/HPF switch for each channel  
Output level display for each channel via  
4 LED VU meters  
Access to installer settings  
Power supply: 230 V 50/60 Hz  
Frequency response: 50 Hz - 15 kHz  
T.H.D (1 kHz nominal power): 0.1%  
Dimensions: 380 x 088 x 482 mm  
19-inch rackable, Height: 2 units  
Weight: 7.5 kg



### AMP120

Public address amplifier 120W -  
8 Ohms/70/100 V

Code : H9903 349€ incl. VAT



RMS power: 120 W  
Output levels / Impedance:  
- 100 V [83 Ohms]  
- 70 V [42 Ohms]  
- 4 Ohms [21.9 V]  
Balanced XLR input/output  
Power output on Phoenix plug  
Frequency response: 70 Hz - 18 KHz  
T.H.D (1 KHz): <1%  
400 Hz High-pass filter  
Power supply: 230 V 50/60 Hz  
- DC24V (safe power)  
Dimensions: 482 x 88 x 330 mm  
19-inch rackable, Height: 2 units  
Net weight: 11.6 Kg

### AMP240

Public address amplifier 240 W -  
8 Ohms/70/100 V

Code : H9904 449€ incl. VAT



RMS power: 240 W  
Output levels / Impedance:  
- 100 V [42 Ohms]  
- 70 V [21 Ohms]  
- 4 Ohms [31 V]  
Balanced XLR input/output  
Power output on Phoenix plug  
Frequency response: 70 Hz - 18 KHz  
T.H.D (1 KHz): <1%  
400 Hz High-pass filter  
Power supply: 230 V 50/60 Hz  
- DC24V (safe power)  
Dimensions: 482 x 88 x 330 mm  
19-inch rackable, Height: 2 units  
Net weight: 13.8 Kg



### MIC-DESK

Announcement microphone fitted with  
'push to talk' system

Code : H9748 69€ incl. VAT



Dynamic capsule  
Frequency response: 40 Hz to 16 kHz  
Sensitivity: -43 dB  
Impedance: 200 Ohms  
Comes with:  
1 XLR 5-pin female / DIN 5-pin male  
5 m cable.  
1 XLR 5-pin female / 6.35 mm mono  
Jack male 3 m cable.  
Dimensions: 430 x 200 x 75 mm  
Weight: 1.05 kg



### REG60

Remote volume adjuster in wall box - 60 W

Code : H9753 25€ incl. VAT



Power: 60 W / 100 V  
24 V Priority input  
Settings: Off/-17 dB/-11 dB/-4.5 dB/0 dB  
Frequency response: 20 Hz - 20 kHz  
White ABS body  
Fixing: REG-BOX (optional)  
Connection: 6-pin connector  
(IN+ IN- / OUT+ OUT- / 0 V 24 V)  
Dimensions: 86 x 86 x 70 mm  
Weight: 0.250 kg.



### REG-BOX

Recessed box for wall adjuster REG60

Code : H9754 2€ incl. VAT



# AMPLIFIERS



## COMBO240

Multi-zone combined mixer amplifier line  
100V combo 5 zones 6 inputs - 240W

Code : H9751

469€ incl. VAT



All-in-one 240W system with multimedia option  
6-input mixer  
5 independent simultaneous zones  
7-band graphic equalizer  
Paging, siren and chime control  
Priority mode and Phantom power on channels 1 and 2  
5-pin DIN input microphone 1  
XLR line or microphone input on channels 2 to 5  
RCA input on channel 6  
Paging input on Phoenix plug  
AMP IN and PRE-AMP OUT connections  
LINK IN and LINK OUT connections  
100 V / 8 to 4 Ohms outputs on the terminal block  
Dimensions: 420 x 320 x 88 mm  
19-inch rackable  
Weight: 10.8 kg

Optional:

### MOD1

USB/SD reader module and AM/FM  
Tuner receiver for COMBO240



- All-in-one system with multimedia option
- 6-input mixer
- 5 Switchable zones
- 7-band graphic equaliser
- Paging and chime control
- 19-inch rackable
- Removable brackets



★★★★★



★★★★★



## COMBO130

Multimedia combined mixer/amplifier/  
reader line 200V 130W Tuner and USB  
reader

Code : H9750

359€ incl. VAT



130W all-in-one system  
5-input mixer:  
3-way microphone - Aux1/MP3/TUNER  
-Aux2  
Low and high settings  
Mp3 and Tuner player controls  
Chime activation  
Output level VU meter  
6.35 input jack for microphones 1 and 2  
RCA input for AUX1 and AUX2  
OUT output on RCA  
Connections for FM and AM antennas  
100 V / 16 to 4 Ohms outputs on the  
terminal block  
Tuner receiver: AM / FM  
Autoscan, Manual scan  
FM frequencies: 87.5 MHz - 108 MHz  
AM frequencies: 522 kHz - 1620 kHz  
USB reader: mp3 files  
Functions: read, search, programming  
time setting  
Power: 220 V 50-60 Hz  
Consumption: 175 W  
Dimensions: 483 x 89 x 366 mm  
Net weight: 11.36 kg



- All-in-one system
- 5-input mixer
- Push-button chimer
- 19-inch rackable
- 70 V/100 V amplified output or low impedance
- 1 front-panel microphone input



★★★★★



★★★★★



**COMBO60**

Multimedia combined mixer/amplifier/reader  
line 100V 60W Tuner and USB reader

Code : H9749

299€ incl. VAT



60W compact all-in-one system  
3-input mixer:  
2-way microphone - Aux1/MP3/TUNER  
Low, mid and high settings  
Mp3 and Tuner player controls  
Output level VU meter  
6.35 input jack for microphones  
AUX input and CD on RCA  
Waiting music input on Phoenix plug  
Paging input on Phoenix plug  
Connections for FM and AM antennas  
100 V / 16 / 8 / 4 Ohms outputs on the terminal block  
Tuner receiver: AM / FM  
Autoscan, Manual scan  
FM frequencies: 87,5 MHz - 108 MHz  
AM frequencies: 522 kHz - 1620 kHz  
USB reader: mp3 files  
Functions: read, search, programming  
time setting  
Power: 220 V 50-60 Hz  
Consumption: 175 W  
Dimensions: 90 x 270 x 260 mm  
Net weight: 5 kg



- Compact all-in-one system
- Integrated USB reader and tuner
- Microphone input and 2 line inputs
- Paging and waiting music compatible
- Priority safety output
- 3-band equalizer



**MOD1**

USB/SD reader module and AM/FM Tuner  
receiver for COMBO240

Code : H9752

189€ incl. VAT



Tuner receiver: AM / FM  
Autoscan, Manual scan  
FM frequencies: 87,5 MHz - 108 MHz  
AM frequencies: 522 kHz - 1620 kHz  
USB reader: mp3 files  
Functions: read, search, programming  
Recognition of more than 2000 files and  
200 folders.  
Equalisation: Classic / Pop / Jazz / Rock  
with the LOUD function  
Technical characteristics:  
Signal-to-noise ratio: Less than 70 dB  
Frequency response: 20 Hz - 20 kHz  
THD: Less than 0.1%  
Maximum consumption: 500 mA

# AMPLIFIERS



## ZONEAMP4120

8 channels and 4 120W outputs at 100V  
Amplified mixer

Code : H10513

829€ incl. VAT



4 Mic/Line inputs on XLR/6.35 Jack (TRS)  
4 stereo inputs on RCA or 6.35 Mono Jack  
4 link out outputs per zone on Phoenix plug  
4 120W at 100V outputs on Phoenix plug  
Microphone priority on input 1  
Phantom power on inputs 1 to 4  
Gain and tone control (3 bands) on channels 1 to 4  
Gain control on all inputs  
Tone control (2 bands) per zone  
5 RJ45 connectors to connect 1x WP-1 per zone and to connect 1 x MIC-DESK4  
General Mute key  
Zone allocation 1 to 4 on each input  
Signal / Peak display on each input  
5 LED VU meters per zone  
AFL / PFL front panel HP monitoring  
Power supply: 230 V 50/60 Hz  
Frequency response: 20 Hz - 20 kHz  
Dimensions: 320 x 088 x 482 mm  
19-inch rackable, Height: 2 units  
Weight: 9 kg



★★★★★



★★★★★



## WP-1

Wall-mounted controller for ZONEAMP4120 or PREZONE444

Code : H10508

39€ incl. VAT



1 front panel XLR microphone input  
1 front panel RCA line input  
1 back panel RJ45 connection  
Front panel volume control  
ON/OFF Switch  
Source display shown by LED  
DC15V power by RJ45 cable from the ZONEAMP4120 or the PREZONE444  
Dimensions: 80 x 80 x 50 mm  
Weight: 0.2kg



## MIC-DESK4

Microphone base for ZONEAMP4120 or PREZONE444

Code : H10509

149€ incl. VAT



1 front panel XLR microphone input  
1 rear RJ45 output  
Talk switch on front panel to enable microphone  
Chime switch to launch chime  
Zone selection switch  
Volume setting (Microphone and Chime)  
Lock/unlock switch to block zone selection  
LED level display  
Power by RJ45 cable from the ZONEAMP4120 or the PREZONE444  
Frequency response: 45 Hz - 15 kHz  
T.H.D (1 kHz nominal power): < 0.1%  
Dimensions: 140 x 60 x 205 mm  
Weight: 0.9kg



### 8 INPUTS

Each input can be routed to your chosen zone or zones.  
Installer settings are accessible with a screwdriver.



### 4 OUTPUTS

The ZONEAMP4120 is equipped with a monitoring loudspeaker to verify the signal sent to each output.

Send your source to the zone of your choice  
Envoyez la source sur la zone de votre choix

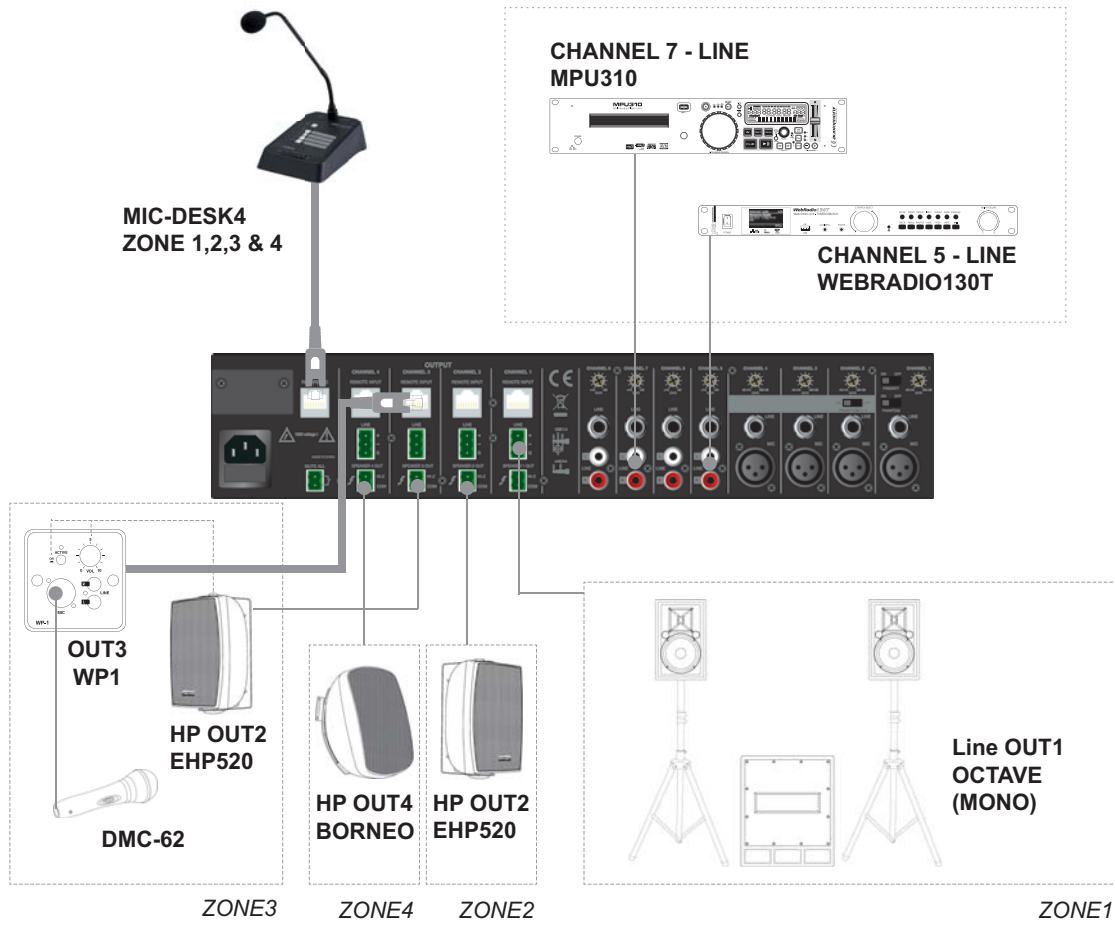

Example of usage of the  
ZONEAMP4120

More information available at: [www.audiophony.com](http://www.audiophony.com)

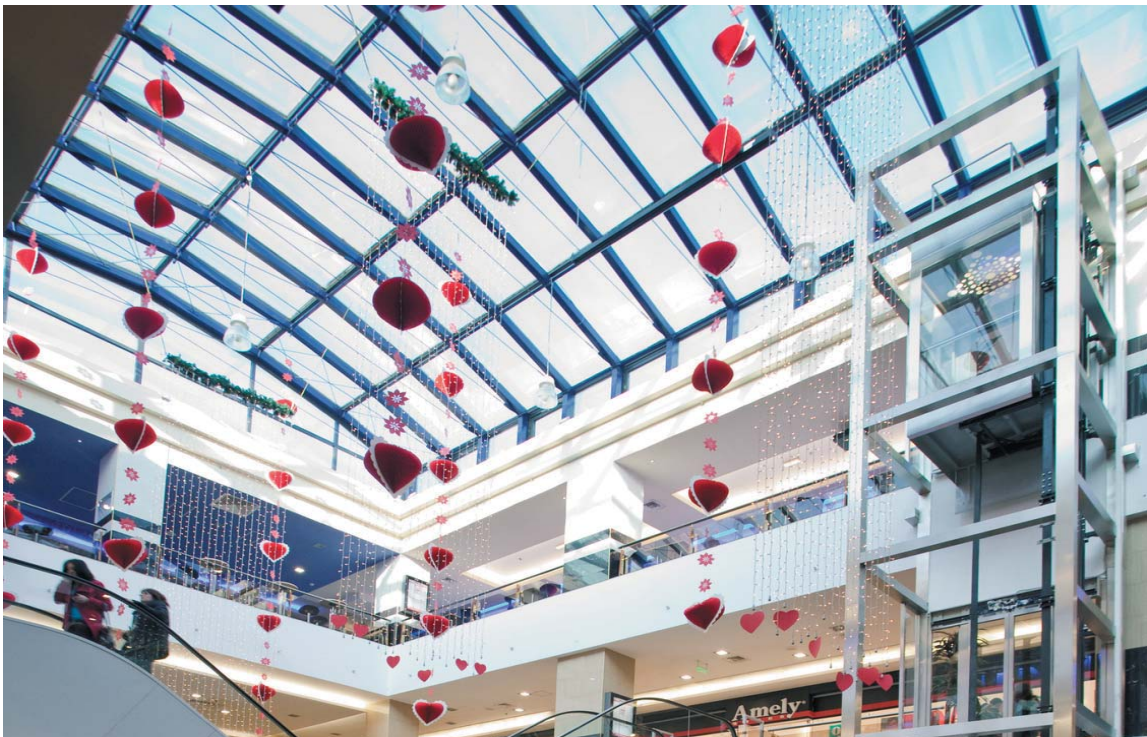

# MULTI SOURCE PLAYERS



## PREZONE444

8 channels and 4 independent output zones mixer

Code : H10507

499€ incl. VAT



4 Mic/Line inputs on XLR/6.35 Jack (TRS)  
 4 stereo inputs on RCA or 6.35 Mono Jack  
 4 line outputs per zone on Phoenix plug  
 Microphone priority on input 1  
 Phantom power on inputs 1 to 4  
 Gain and tone (3 bands) on input 1 to 4  
 Gain control on all inputs  
 Tone control (2 bands) per zone  
 5 RJ45 connectors to connect 1x WP-1 per zone and to connect 1x MIC-DESK4  
 General Mute key  
 Zone allocation 1 to 4, on each input  
 Signal / Peak display on each input  
 5 LED VU meters per zone  
 AFL / PFL front panel HP monitoring  
 Power supply: 230 V 50/60 Hz DC 24V  
 Dimensions: 320 x 088 x 482 mm  
 19-inch rackable, Height: 2 units Weight: 5 kg



## COMPATIBLE WP1 AND MIC-DESK4

The WP1 enables remote input from another room and to control the volume in that zone.

The MIC-DESK4 enables announcements to be made in selected zones.

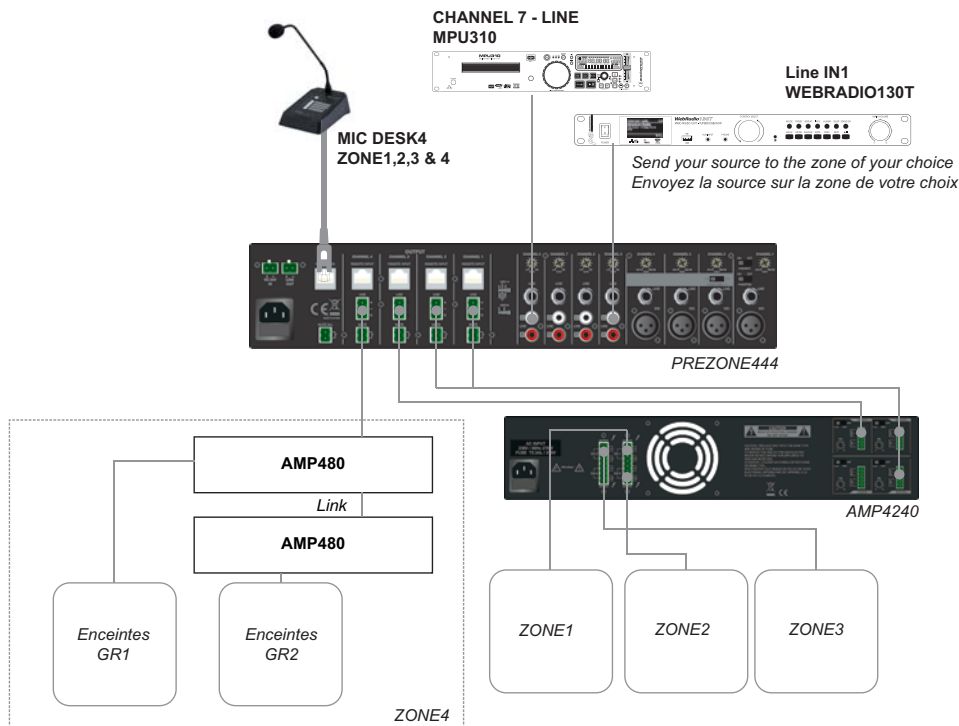



### PREZONE642

Mixer 10 inputs/Preamp 2 zones 6 microphone inputs - 4 line inputs - 2 zones

Code : H9902

369€ incl. VAT



6 Mic/Line inputs on XLR/6.35 Jack  
 CH1 and 2 phantom power and priority microphone  
 4 stereo inputs on RCA or Jack  
 Zones 1 and 2 balanced outputs on XLR  
 Balanced SUB output per zone on Jack  
 Stereo REC Output output on RCA  
 Gain and tone (3 bands) on inputs 1 to 4  
 Gain setting on stereo inputs  
 Tone control (2 bands) per zone  
 SUB volume per zone setting  
 Zone allocation and PFL per input  
 LED signal and Peak display  
 8 LED VU meters per zone  
 Headphone output with volume (zones and PFL)  
 Power supply: 230 V 50/60 Hz DC24V  
 Dimensions: 295 x 085 x 482 mm  
 19-inch rackable, Height: 2 units  
 Weight: 5 kg



### MICROPHONE AND LINE INPUT

#### EACH MICROPHONE INPUT HAS:

- Gain setting
- 3-band equalizer
- These settings are reserved for installation and can only be modified by means of a screwdriver

#### EACH LINE INPUT HAS:

- Gain setting. (This setting is reserved for installation and can only be modified by means of a screwdriver)

### AN ADVANCED MASTER SECTION

#### EACH ZONE HAS:

- Its own volume
- Its own equalisation
- Its own SUB output level setting
- Its own output level display

#### THE HEADPHONE SECTION IS ADVANCED WITH:

- Listening selection per channel via a PFL switch per increment
- The possibility to listen to each output independently via a zone selector.



### PM4.2 MEDIAMIX

An all-in-one solution with FM RDS, USB reader and 2-zone balanced outputs.

Code : B00124

229€ incl. VAT



Internal USB reader compatible with MP3, WMA and WAV files.  
 FM RDS radio with pre-set stations  
 Infrared remote control  
 Reading of 3 priority messages (manual and programmed reproduction)  
 Audio mixer up to 4 sources:  
 - USB reader/FM radio  
 - 2 external line inputs  
 - Microphone input with adjustable automatic talkover  
 Recording output per RCA plug balanced outputs per zone  
 Priority urgent message input.  
 Muting of main channels. (contact closed = muting)  
 Power supply: AC 100/240V - 50/60Hz  
 Dimensions: 483 x 44 x 162 mm  
 Net weight: 3.5 kg

# MULTI SOURCE PLAYERS



## MXU230T

CD/USB/SD reader 3-way mixer + tuner

Code : H10182

449€ incl. VAT



CD/Mp3 reader with anti-shock memory  
 USB/SD/SDHC (FAT32 16G0 max) reader  
 Output volume control  
 AM / FM tuner with 10-memory auto-scan  
 Navigation dial  
 Aux input on 3,5mm Jack  
 Microphone 1 on front panel 6.35 jack  
 Microphones 2 and 3 on rear panel  
 6.35 jack  
 Outputs 1 and 2 on RCA  
 Separate line and microphone control  
 Infrared remote control supplied  
 Power supply: AC 100/240V - 50/60Hz  
 or DC12V  
 Dimensions: 483 x 44 x 275 mm  
 Net weight: 3.4 kg



- CD/USB/SD reader to read your mp3 files on all supports
- AM/FM tuner
- Mixer to control up to 2 supplementary lines and 3 supplementary microphones



★★★★★



★★★★★



★★★★★



★★★★★



## USB3.1-RDS

CD / USB /Tuner reader

Code : B00364

259€ incl. VAT



The USB3.1-RDS reader combines different audio sources.  
 AM/FM radio with RDS system and 18 pre-set stations  
 MP3/WMA compatible audio CD reader  
 USB/SD/SDHC reader up to 64 Go MP3/WMA sampling up to 48 kHz/320 kbit/s  
 1 RCA Tuner output / 1 RCA CD output  
 1 mixed RCA output  
 RS-232 input for home automation systems  
 Power supply: AC 100/240V - 50/60Hz  
 DC 24 V back-up power supply  
 Dimensions: 482 x 44 x 330 mm  
 Net weight: 4 kg



- 1 RCA Tuner output / 1 RCA CD output
- 1 mixed RCA output
- AM/FM radio: with RDS system and 18 pre-set stations
- MP3/WMA CD reader
- USB/SD card media reader



★★★★★



★★★★★



★★★★★



★★★★★





### MPU130T

CD MP3 + USB /SD reader + tuner

Code : H9764

349€ incl. VAT



CD/Mp3 reader with anti-shock memory  
 USB/SD/SDHC (FAT32 16GB max) reader  
 Output volume control  
 AM / FM tuner with 10-memory auto-scan  
 Navigation dial  
 Programmable or random shuffle playlist  
 Single-ended output (-10 dB) on RCA  
 Infrared remote control supplied  
 Power supply: AC 100/240V - 50/60Hz or DC12V  
 Dimensions: 482 x 44 x 275 mm  
 Net weight: 3.4 kg

### SOURCE CONTROL

The MPU130T is a true multimedia centre capable of supplying a continuous sound atmosphere no matter what the source is.

It's very easy to use thanks to its single output, it can be controlled independently by remote control, or directly from the front panel. Its USB and SD ports give access to hundreds of hours of non-stop music that can be pre-programmed or read randomly.



★★★★★



★★★★★



★★★★★



★★★★★



### WEBRADIO130T

Connected multimedia reader

Code : H10183

469€ incl. VAT



Radio: Ethernet / Wifi Internet radio, DAB and DAB+ digital radio, FM with RDS  
 Mp3 reader: USB port for reading mp3/AAC/WMA/FLAC files on USB flash drive or FAT32 external disk drive  
 Shared files: Audio file sharing available on your computer network to pool your favourite playlists  
 Programmable power on:  
 Infrared remote control  
 Aux input on 3.5mm Jack  
 Line level outputs on RCA and Headphone on 3.5mm Jack  
 Power supply: 230V - 50/60Hz or DC12V  
 Dimensions: 483 x 44 x 265 mm  
 Net weight: 2.9 kg



- Internet or DAB radio for an international selection of digital music
- USB port to play MP3 files on your hard drive
- Share audio files on your computer network



★★★★★



★★★★★



★★★★★



★★★★★

# HEARING LOOP SYSTEM

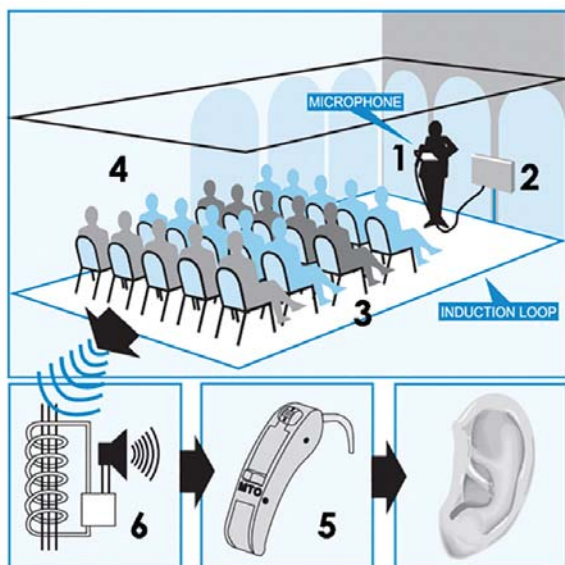

## ABOUT THE HEARING LOOP SYSTEM

A hearing loop or induction loop is a hearing aid system for the hearing-impaired using a magnetic induction loop.

With this system, the sound from a speaker's microphone, PA equipment, TV set, etc. is transmitted wirelessly to the hearing aid of the person, who can hear it without being disturbed by any ambient noise. This system is mainly used in public places (conference rooms, cinemas, courts, churches, counters, etc.)

A large number of conventional hearing aids incorporate the "T" loop function.

Hearing loops are mainly installed in rooms.

The installation consists of an electrical wire that travels around the perimeter of the room thus forming a loop. This loop is connected to an audio amplifier. The hearing aid has a coil, often called "T" or "T-coil".

This coil, placed inside the hearing aid, is also made of a wire that makes a large number of turns.

## MAGNETIC FIELD

The magnetic field generated by the large loop around the room will cross the small loops in the hearing aid and, by the principle of induction, the electrical signal present in the large loop will end up in the small ones.

This is how the signal from the audio amplifier is transmitted to the hearing aid, which will then return it to the ear of the hearing-impaired person.



## REGULATIONS

The 2005 - 102 Act of 11 February 2005 sets out the requirement for public establishments to be accessible to people with disabilities before 1 January 2018

This obviously applies to establishments open to the public, such as:

Administrative and cultural facilities,

Health buildings,

Sports facilities,

But also supermarkets, cinemas, public transport, etc.

Facilities must comply with the standard: EN 60118-4:

Background noise (electromagnetic pollution) must be < 32 dB at 400 mA/m

The magnetic field must be between +/- 3 dB for a signal from 1 kHz to 400 mA/m

The frequency response must be 100 Hz - 5 kHz at +/- 3dB

**NEW**



**BM-PORTABLE**  
Portable and autonomous loop amplifier

Code : H10799      339€ incl. VAT



This portable loop system makes it easy to equip a desk or counter. Made of ABS, it has an integrated microphone, amplifier, rechargeable battery and an induction loop for a coverage of: 1.2 m<sup>2</sup>. Charger included.

**NEW**



**BM-KIT**  
Loop amplifier kit for counter use

Code : H10795      259€ incl. VAT



Induction loop kit for equipping: counters, reception desks or service desks. This kit includes:  
1 x induction loop amplifier  
1 x surface microphone  
1 x loop  
1 x power supply  
3 x "Space adapted for the hearing-impaired" stickers.  
2 inputs: 1 microphone/line and 1 line  
Phantom power  
Compressor and noise limiter  
Output protection and control  
Power: 230 V 50/60 Hz - 12 V DC 1.5 A  
Size: 92 x 52 x 18 mm  
Weight: 0.850 kg

**NEW**



**BM-A250**  
Loop amplifier for 250 m<sup>2</sup> area

Code : H10796      799€ incl. VAT



Class D amplifier for approximately 250 m<sup>2</sup>  
3 inputs: 2 line or microphone inputs (connector: 1 Phoenix and Combo), 1 priority 100 V input  
Monitoring and detection of power supply, amplifier and loop faults with NO-NC relay.  
Automatic gain control  
Correction control due to metal losses  
Power: 230 V 50/60 Hz  
Size: 483 x 43 x 215 mm  
Weight: 2.47 kg

**NEW**



**BM-A1000**  
Loop amplifier for 1000 m<sup>2</sup> area

Code : H10797      999€ incl. VAT



Class D amplifier for approximately 1000 m<sup>2</sup>  
3 inputs: 2 line or microphone inputs (connector: 1 Phoenix and Combo), 1 priority 100 V input  
Monitoring and detection of power supply, amplifier and loop faults with NO-NC relay.  
Integrated phase shift module (output 90° or 0°)  
Automatic gain control  
Correction control due to metal losses  
Power: 230 V 50/60 Hz  
Size: 483 x 43 x 215 mm  
Weight: 2.47 kg

**NEW**



**BM-TEST**  
Hearing aid simulator for loop amp test

Code : H10798      179€ incl. VAT



BM-TEST is a compact listening device for magnetic induction loop systems. It can be used in different situations:

- To determine if an induction loop is working properly
- For hearing-impaired people who do not wear a hearing aid
- For wearers of hearing aids that do not have a "T" function

The kit comprises:  
1 x loop receiver  
1 x headset  
2 x AAA batteries  
Frequency response: 20 Hz - 6 kHz  
Battery life: >100 hours

**NEW**



**BM-SCAN**  
Magnetic field meter

Code : H10878      999€ incl. VAT



The BM-SCAN field strength meter has been designed to ensure that magnetic loop systems are installed and certified according to the new IEC 60118-4 standard. When these standards are met, the comfort of the user will be identical wherever he/she uses a hearing aid with the T position.

3.5 mm headphone jack socket  
Power supply: 9 V battery (not included)

**NEW**



**BM-Cu50**  
Copper tape 50 m - 18 mm wide x 0.1 mm thick

Code : H10800      149€ incl. VAT



The BM-Cu50 is an 18-mm wide, 0.1-mm thick (1.8 mm<sup>2</sup> cross-section) copper tape insulated by a 0.05 mm Melinex band. Resistance +/- 10mΩ/m.  
Cables specially designed for induction loops where the loop must go under carpets or in places not suitable for conventional cables.

50 m coil

**NEW**



**BM-Cu100**  
Copper tape 100 m - 18 mm wide x 0.1 mm thick

Code : H10801      299€ incl. VAT



The BM-Cu100 is a 18 mm wide, 0.1-mm thick (1.8 mm<sup>2</sup> cross-section) copper tape insulated by a 0.05 mm Melinex band. Resistance +/- 10mΩ/m.  
Cables specially designed for induction loops where the loop must go under carpets or in places not suitable for conventional cables.

100 m coil

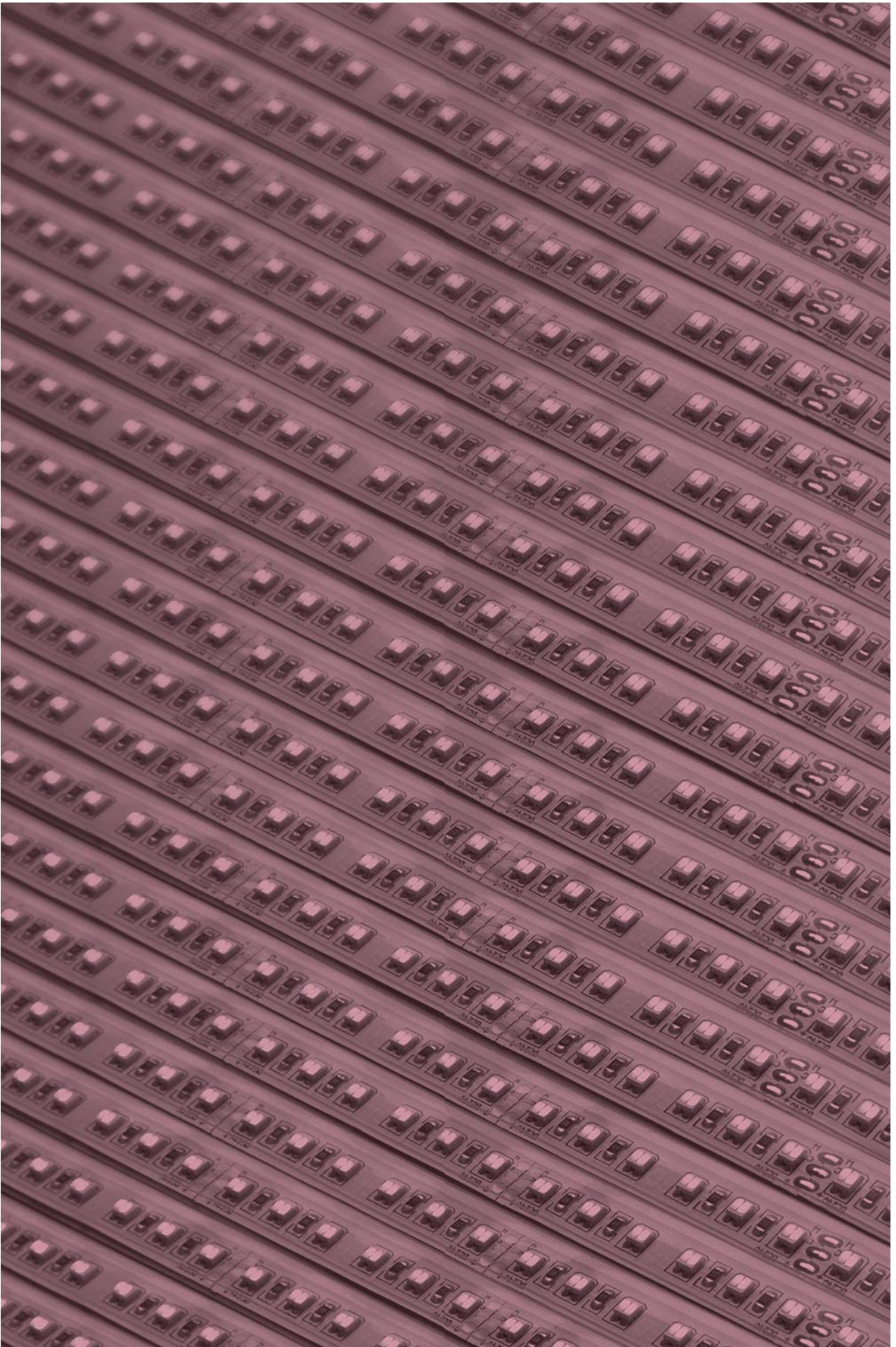

# LIGHT INTEGRATION

LED RIBBONS  
CONTROLLERS  
DRIVERS  
BOOSTERS AND MANAGERS  
POWER SUPPLIES  
PROFILES AND DIFFUSERS  
ACCESSORIES  
DECORATION PROJECTORS

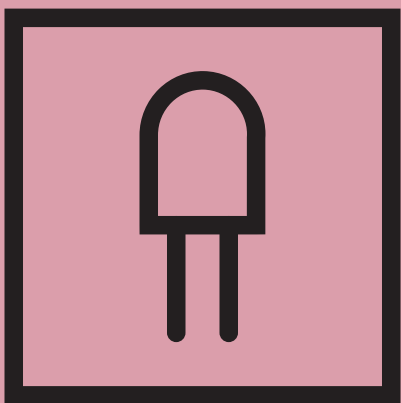



# LED RIBBONS

Intense colours, bright white or softened light, our ribbons ensure an exceptional rendering in ambient lighting as well as enhancing your spaces.

IP67	60 LEDs/m	LED SMD 5050	Ra 80
			
<b>PURETAPE6067-WARM</b> 3000°K White LED ribbon Roll of 5 meters - IP67 - 60 LEDs/meter			
Code : H9861		89€ incl. VAT	
			

Monochrome adhesive ribbon of 300 warm white LEDs for 5m  
 Colour temperature: 3000°K  
 Luminosity: 1080 lumens/m  
 Power required: 14.4W/m (72W for 5m)  
 Voltage required: 24V (+ and -)  
 Cutable every 10 cm (6LEDs)  
 IP67: Full silicone sheath

IP65	60 LEDs/m	LED SMD 5050	Ra 80
			
<b>LSI-60WW-5050-IP65-5M</b> Very bright flexible light strip (1320lm / m) containing 60 5050-SMD white LEDs/meter.			
Code : B05414		64,90€ incl. VAT	
			

Monochrome adhesive ribbon of 300 warm white LEDs for 5m  
 Colour temperature: 3000°K  
 Luminosity: 1320 lumens/m  
 Power required: 14.4W/m (72W for 5m)  
 Voltage required: 24V (+ and -)  
 Cutable every 10 cm (6LEDs)  
 IP65: Upper molded silicone dome

IP20	60 LEDs/m	LED SMD 5050	Ra 80
			
<b>PURETAPE6020-WARM</b> 3000°K White LED ribbon Roll of 5 meters - IP20 - 60 LEDs/meter			
Code : H10535		69€ incl. VAT	
			



Monochrome adhesive ribbon of 300 warm white LEDs for 5m  
 Colour temperature: 3000°K  
 Luminosity: 915 lumens/m  
 Power required: 14.4W/m (72W for 5m)  
 Voltage required: 24V (+ and -)  
 Cutable every 10 cm (6LEDs)  
 IP20: no protection no sealing

IP20	60 LEDs/m	LED SMD 5050	Ra 80
			
<b>LSI-60WW-5050-IP20-5M</b> Highly luminous flexible light strip (1320lm/m) containing 60 SMD-5050 white LEDs/meter.			
Code : B05413		54,90€ incl. VAT	
			

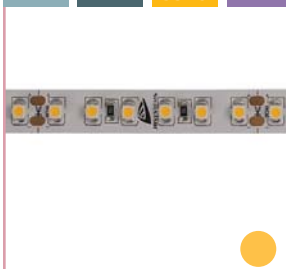
Monochrome adhesive ribbon of 300 warm white LEDs for 5m  
 Colour temperature: 3000°K  
 Luminosity: 1320 lumens/m  
 Power required: 14.4W/m (72W for 5m)  
 Voltage required: 24V (+ and -)  
 Cutable every 10 cm (6LEDs)  
 IP20: no protection no sealing

IP20	120 LEDs/m	LED SMD 3528	Ra 80
			
<b>LSI-120WW-3528-IP20-20M</b> JB SYSTEMS Highly luminous flexible light strip (960lm/m) containing 120 white LEDs/meter.			
Code : B05412		199€ incl. VAT	
			

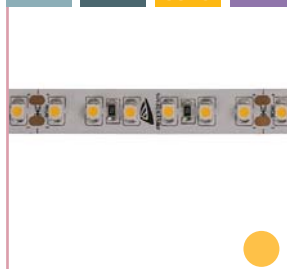
Long monochrome adhesive ribbon of 2400 warm white LEDs for 20m  
 Colour temperature: 3000°K  
 Luminosity: 960 lumens/m  
 Power required: 9.6W/m (192W for 20m)  
 Voltage required: 24V (+ and -)  
 Cutable every 5 cm (6LEDs)  
 IP20: no protection no sealing

IP20	120 LEDs/m	LED SMD 3528	Ra 80
			
<b>LSI-120WW-3528-IP20-5M</b> JB SYSTEMS Highly luminous flexible light strip (960lm/m) containing 120 white LEDs/meter.			
Code : B05410		49€ incl. VAT	
			

Monochrome adhesive ribbon of 600 warm white LEDs for 20m  
 Colour temperature: 3000°K  
 Luminosity: 960 lumens/m  
 Power required: 9.6W/m (48W for 5m)  
 Voltage required: 24V (+ and -)  
 Cutable every 5 cm (6LEDs)  
 IP20: no protection no sealing

IP65	120 LEDs/m	LED SMD 3528	Ra 80
			
<b>LSI-120WW-3528-IP65-5M</b> JB SYSTEMS Highly luminous flexible light strip (960lm/m) containing 120 white LEDs/meter.			
Code : B05411		62,90€ incl. VAT	
			

Monochrome adhesive ribbon of 600 warm white LEDs for 20m  
 Colour temperature: 3000°K  
 Luminosity: 960 lumens/m  
 Power required: 9.6W/m (48W for 5m)  
 Voltage required: 24V (+ and -)  
 Cutable every 5 cm (6LEDs)  
 IP65: Upper molded silicone dome

IP20	144 LEDs/m	LED SMD 5630	Ra 80
			
<b>PURETAPE14420-WARM</b> 3000°K White LED ribbon Roll of 5 meters - IP20 - 144 LEDs/meter			
Code : H10536		229€ incl. VAT	
			

Double monochrome adhesive ribbon of 720 warm white LEDs for 5m  
 Colour temperature: 3000°K  
 Luminosity: 2452 lumens/m  
 Power required: 47.5W/m (238W for 5m)  
 Voltage required: 24V (+ and -)  
 Cutable every 8.4 cm (12 LEDs)  
 IP20: no protection no sealing

IP67	60 LEDs/m	LED SMD 5050	Ra 85
------	-----------	--------------	-------



**PURETAPE6067-COLD**  
6000°K White LED ribbon  
Roll of 5 meters - IP67 - 60 LEDs/meter

Code : H9862      89€ incl. VAT



Monochrome adhesive ribbon of 300  
Colour temperature: 6000°K  
Luminosity: 1170 lumens/m  
Power required: 14.4W/m (72W for 5m)  
Voltage required: 24V (+ and -)  
Cutttable every 10 cm (6LEDs)  
IP67: Full silicone sheath

IP20	60 LEDs/m	LED SMD 5050	Ra 85
------	-----------	--------------	-------



**PURETAPE6020-COLD**  
6000°K White LED ribbon  
Roll of 5 meters - IP20 - 60 LEDs/meter

Code : H10537      69€ incl. VAT



Monochrome adhesive ribbon of 300 cold white LEDs for 5m  
Colour temperature: 6000°K  
Luminosity: 1190 lumens/m  
Power required: 14.4W/m (72W for 5m)  
Voltage required: 24V (+ and -)  
Cutttable every 10 cm (6LEDs)  
IP20: no protection no sealing

IP20	120 LEDs/m	LED SMD 3527	Ra 80-85
------	------------	--------------	----------



**PURETAPE12020-WARMCOLD**  
3000+6000°K White LED ribbon  
Roll of 5 meters - IP20 - 120 LEDs/meter

Code : H10539      149€ incl. VAT



Two-tone adhesive ribbon of 600 warm and cold white LEDs for 5m  
Colour temperature: 3500K/6500K  
Luminosity: 1264 lumens/m  
Power required: 19.2 W/m (96W for 5m)  
Voltage required: 24V (+ and -)  
Cutttable every 5.3cm (6 LEDs)  
IP20: no protection no sealing

IP67	120 LEDs/m	LED SMD 3527	Ra 80-85
------	------------	--------------	----------



**PURETAPE12067-WARMCOLD**  
3000+6000°K White LED ribbon  
Roll of 5 meters - IP67 - 120 LEDs/meter

Code : H10540      159€ incl. VAT



Two-tone adhesive ribbon of 600 warm and cold white LEDs for 5m  
Colour temperature: 3500K/6500K  
Luminosity: 1264 lumens/m  
Power required: 19.2 W/m (96W for 5m)  
Voltage required: 24V (+ and -)  
Cutttable every 5.3cm (6 LEDs)  
IP67: Full silicone sheath

IP20	144 LEDs/m	LED SMD 5630	Ra 85
------	------------	--------------	-------



**PURETAPE14420-COLD**  
6000°K White LED ribbon  
Roll of 5 meters - IP20 - 144 LEDs/meter

Code : H10538      229€ incl. VAT



Double monochrome adhesive ribbon of 720 cold white LEDs for 5m  
Colour temperature: 6000°K  
Luminosity: 3065 lumens/m  
Power required: 47.5W/m (238W for 5m)  
Voltage required: 24V (+ and -)  
Cutttable every 8.4 cm (12 LEDs)  
IP20: no protection no sealing

## POSSIBLE CONFIGURATIONS

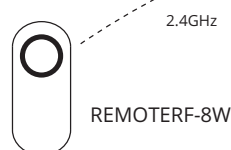
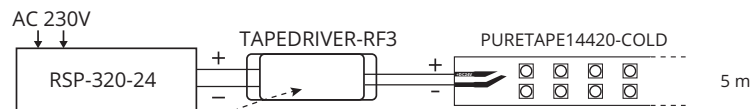
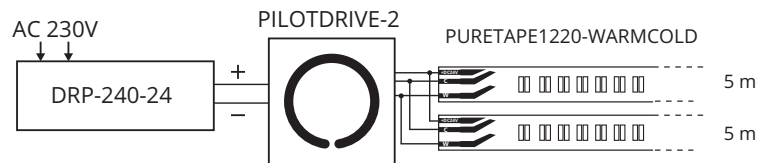

# LED RIBBONS

Intense colours, bright white or softened light, our ribbons ensure an exceptional rendering in ambient lighting as well as enhancing your spaces.

IP67	60 LEDs/m	LED SMD 5050
		
		
<b>COLOURTAPE6067</b> 3-colour LED ribbon Roll of 5 meters - IP67 - 60 LEDs/meter		
Code : H9860	89€ incl. VAT	
		

Trichromatic adhesive ribbon of 300 RGB LEDs for 5m  
Luminosity: 510 lumens/m  
Power required: 14.4W/m [72W for 5m]  
Voltage required: 24V (+ and -)  
Cuttable every 10 cm [6LEDs]  
IP67: Full silicone sheath

IP65	60 LEDs/m	LED SMD 5050
		
		
<b>COLOURTAPE6065</b> 3-colour LED ribbon Roll of 5 meters - IP65 - 60 LEDs/meter		
Code : H9994	79€ incl. VAT	
		

Trichromatic adhesive ribbon of 300 RGB LEDs for 5m  
Luminosity: 510 lumens/m  
Power required: 14.4W/m [72W for 5m]  
Voltage required: 24V (+ and -)  
Cuttable every 10 cm [6LEDs]  
IP65: Upper molded silicone dome

IP65	60 LEDs/m	LED SMD 5050
		
		
<b>LSI-60RGB-5050-IP65-5M</b> JB SYSTEMS Flexible "colour changing" LED strip containing 60 RGB LEDs/meter.		
Code : B05418	72,90€ incl. VAT	
		

Trichromatic adhesive ribbon of 300 RGB LEDs for 5m  
Luminosity: 540 lumens/m  
Power required: 14.4W/m [72W for 5m]  
Voltage required: 24V (+ and -)  
Cuttable every 10 cm [6LEDs]  
IP65: Upper molded silicone dome

IP20	60 LEDs/m	LED SMD 5050
		
		
<b>COLOURTAPE6020</b> 3-colour LED ribbon Roll of 5 meters - IP20 - 60 LEDs/meter		
Code : H10541	69€ incl. VAT	
		

Trichromatic adhesive ribbon of 300 RGB LEDs for 5m  
Luminosity: 560 lumens/m  
Power required: 14.4W/m [72W for 5m]  
Voltage required: 24V (+ and -)  
Cuttable every 10 cm [6LEDs]  
IP20: no protection no sealing

IP20	60 LEDs/m	LED SMD 5050
		
		
<b>LSI-60RGB-5050-IP20-5M</b> Flexible "colour changing" LED strip containing 60 RGB LEDs/meter.		
Code : B05417	59€ incl. VAT	
		

Trichromatic adhesive ribbon of 300 RGB LEDs for 5m  
Luminosity: 540 lumens/m  
Power required: 14.4W/m [72W for 5m]  
Voltage required: 24V (+ and -)  
Cuttable every 10 cm [6LEDs]  
IP20: no protection no sealing

IP20	60 LEDs/m	LED SMD 5050
		
		
<b>LSI-60RGB-5050-IP20-20M</b> Flexible "colour changing" LED strip containing 60 RGB LEDs/meter.		
Code : B05419	219€ incl. VAT	
		

Long 3-colour adhesive ribbon of 1200 RGB LEDs for 20m  
Luminosity: 540 lumens/m  
Power required: 14.4W/m [288W for 20m]  
Voltage required: 24V (+ and -)  
Cuttable every 10 cm [6LEDs]  
IP20: no protection no sealing

IP65	30 LEDs/m	LED SMD 5050
		
		
<b>COLOURTAPE3065</b> 3-colour LED ribbon Roll of 5 meters - IP65 - 30 LEDs/meter		
Code : H9859	59€ incl. VAT	
		

Trichromatic adhesive ribbon of 150 RGB LEDs for 5m  
Luminosity: 255 lumens/m  
Power required: 7.2W/m [36W pour 5m]  
Voltage required: 24V (+ and -)  
Cuttable every 10 cm [3LEDs]  
IP65: Upper molded silicone dome

IP65	30 LEDs/m	LED SMD 5050
		
		
<b>LSI-30RGB-5050-IP65-5M</b> Flexible "colour changing" LED strip containing 30 RGB LEDs/meter.		
Code : B05416	49,90€ incl. VAT	
		

Trichromatic adhesive ribbon of 150 RGB LEDs for 5m  
Luminosity: 270 lumens/m  
Power required: 7.2W/m [36W pour 5m]  
Voltage required: 24V (+ and -)  
Cuttable every 16.7 cm  
IP65: Upper molded silicone dome



IP20	30 LEDs/m	LED SMD 5050
------	-----------	--------------



**LSI-30RGB-5050-IP20-5M**  
Flexible "colour changing" LED strip containing 30 RGB LEDs/meter.

Code : B05415      35,90€ incl. VAT



Long 3-colour adhesive ribbon of 600 RGB LEDs for 20m  
Luminosity: 270 lumens/m  
Power required: 7.2W/m (36W pour 5m)  
Voltage required: 24V (+ and -)  
Cuttable every 16.7 cm  
IP20: no protection no sealing

IP65	30 LEDs/m	LED SMD 5050
------	-----------	--------------



**FL30-RGB SET-5050-3M**  
RGB flexible LED strip set, Length = 3m, incl IR-remote

Code : B05352      39€ incl. VAT



3-colour adhesive bars with 6x30 RGB LED strips for 3m in total  
Voltage required: 24V (+ and -)  
IP65: Upper molded silicone dome  
Complete set supplied with power supply, controller, remote control and 6 strips of 50cm.

IP67	60 LEDs/m	LED SMD 5054	Ra 80-85
------	-----------	--------------	----------



**COLOURTAPE6067-WARM**  
4-colour LED ribbon  
Roll of 5 meters - IP67 - 60 LEDs/meter

Code : H10543      139€ incl. VAT



Ribbon of 300 4-colour RGBW LEDs for 5m  
Luminosity: 646 lumens/m  
Power required: 19.2W/m (96W for 5m)  
Voltage required: 24V (+ and -)  
Cuttable every 10 cm (6 LEDs)  
IP67: Full silicone sheath

IP20	60 LEDs/m	LED SMD 5054	Ra 80-85
------	-----------	--------------	----------



**COLOURTAPE6020-WARM**  
LED ribbon 4-colour  
Roll of 5 meters - IP20 - 60 LEDs/meter

Code : H10542      129€ incl. VAT



Ribbon of 300 4-colour RGBW LEDs for 5m  
Luminosity: 879 lumens/m  
Power required: 19.2W/m (96W for 5m)  
Voltage required: 24V (+ and -)  
Cuttable every 10 cm (6 LEDs)  
IP20: no protection no sealing

IP67	30 LEDs/m	LED SMD 5050
------	-----------	--------------



**FLEXILED BLUE / 5M**  
Flexible led strip blue, L=5m, 24V

Code : B05347      49€ incl. VAT



Blue adhesive ribbon with 300 LEDs for 5m  
Power required: 7.2W/m (36W pour 5m)  
Voltage required: 24V (+ and -)  
Cuttable every 16.5 cm  
IP65: Upper molded silicone dome

NEW	IP20	60 LEDs/m	LED SMD 5050
-----	------	-----------	--------------



**UVRIBBON6020**  
UV ribbon - 395nm  
Roll of 5 meters - IP20 - 60 LEDs/meter

Code : H10771      129€ incl. VAT



UltraViolet adhesive ribbon with 300 LEDs for 5m  
Power required: 14.4W/m (72W for 5m)  
Voltage required: 24V (+ and -)  
Cuttable every 10cm (6 leds)  
IP20: no protection no sealing

NEW	IP67	60 LEDs/m	LED SMD 5050
-----	------	-----------	--------------





**UVTAPE6067**  
UV ribbon - 395nm  
Roll of 5 meters - IP67 - 60 LEDs/meter

Code : H10772      139€ incl. VAT

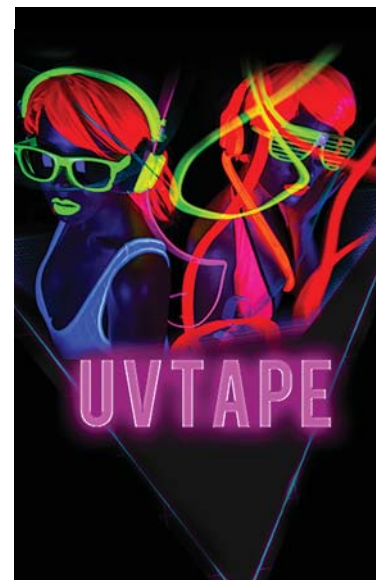

UltraViolet adhesive ribbon with 300 LEDs for 5m  
Power required: 14.4W/m (72W for 5m)  
Voltage required: 24V (+ and -)  
Cuttable every 10cm (6 leds)  
IP67: Full silicone sheath



# ADVANTAGES of the LEDs?

- Long life, low maintenance
- Low energy cost
- Resistant to shocks and vibrations
- Very compact format
- No infrared and UV emissions

Ra  
80

## RA OR CRI

An Ra equal to 100 corresponds to natural daylight. At this level, the colours are perceived without any change (or loss) for the human eye.

LEDs which diffuse artificial light cannot claim an CRI greater than 90. In places that require that colours are complied with (e.g. points of sale or exhibitions), it is essential to provide equipment with an index greater than 70).

## COLOUR TEMPERATURE

The unit of colour temperature is Kelvin degree (K°).

The lower the degree of temperature, the warmer the light. The higher the degree of temperature, the colder the light.



## WHAT TYPE OF LED?



—  
5054: 4 chips (RGBW)  
of 0.32w/led  
Good brightness

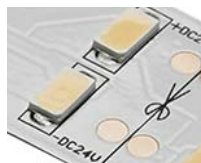

—  
5630: 1 chip of 0.33w/led  
Very high brightness  
Only monochrome



—  
5050: 3 chips (RGB) of  
0.24w/led  
Good brightness



—  
5050: 1 hot white or cold  
white chip of 0.24w/led  
High brightness

## Ideal for ambient lighting



—  
3527: 2 chips (warm white  
cold white) of 0.16w/led



—  
WS2812B:  
3 RGB chips of 0.24w/led with integrated control circuit  
Each LED can be controlled independently

The ribbons of the SMARTTAPE range are equipped with the latest WS2812B LED technology. In SMD5050 (5x5mm) format, the integrated control circuit is directly embedded in the component. More discreet, these LEDs make it possible to have ribbons of only 10mm width with a pitch of only 16mm for the SMARTTAPE6020 model.

The installation is very simple, as only 3 cables are needed for operation (+, -, Data in).

Associated with a power supply and a SMARTCTL controller, you will get 300 kinds of patterns with the ability to control the speed and brightness.



## FLEX LED PIXEL

IP20	30 LEDs/m	LED WS2812B	PIXEL
<b>SMARTTAPE3020</b> 3-colour pixel LED strip of 30 LEDs/meter - IP20 - 5V			
Code : H10596		65€ incl. VAT	
<b>Contest</b>			

3-colour adhesive ribbon of 150 RGB LEDs for 5m pixel version  
Power required: 7.2W/m (36W pour 5m)  
Voltage required: 5V DC  
Cutttable every 3.3cm (1 LED)  
IP20: no protection no sealing

IP20	60 LEDs/m	LED WS2812B	PIXEL
<b>SMARTTAPE6020</b> 3-colour pixel LED strip of 60 LEDs/meter - IP20 - 5V			
Code : H10597		99€ incl. VAT	
<b>Contest</b>			

3-colour adhesive ribbon of 300 RGB LEDs for 5m pixel version  
Power required: 14.4W/m (72W for 5m)  
Voltage required: 5V DC  
Cutttable every 1.6 cm (1 LED)  
IP20: no protection no sealing

<b>SMARTCTL</b> HF remote control for SMARTTAPE ribbons of 2048 pixel max. - VDC	
Code : H10598	22€ incl. VAT
<b>Contest</b>	

Power supply: 5V DC  
Max controlled number of pixels: 2048  
Remote control : 433.92 MHz  
Remote control range: 30m

<b>100W 5V</b>	
<b>LRS-100-5</b> 5V DC 100W max. power supply IP20 1 output	
Code : H10600	49€ incl. VAT
<b>Contest</b>	

Power supply: 5V DC 100W max.  
Output voltage : 5V DC - 20A  
Power rating: 100 W  
Supply voltage : 100 - 240V AC

<b>50W 5V</b>	
<b>LRS-50-5</b> 5V DC 50W max. power supply IP20 1 output	
Code : H10599	39€ incl. VAT
<b>Contest</b>	

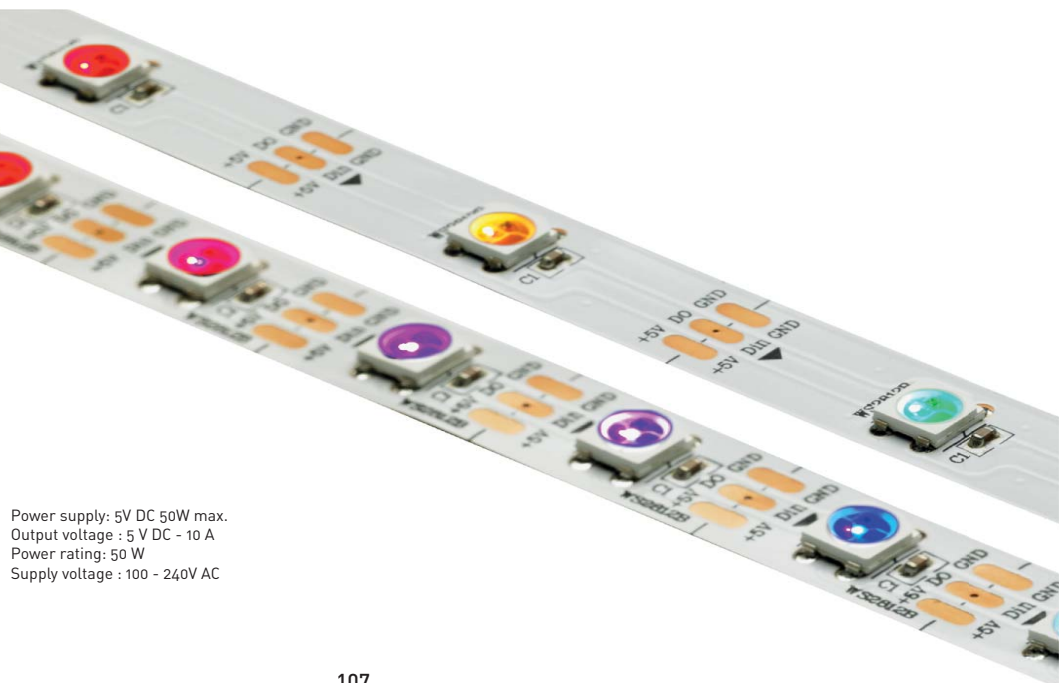

Power supply: 5V DC 50W max.  
Output voltage : 5 V DC - 10 A  
Power rating: 50 W  
Supply voltage : 100 - 240V AC

# TOUCH CONTROLLERS

Light at your fingertips.

Discover our new range of fully tactile and recessed LED light controllers. Fluid and highly accurate, choose the intensity and colour of your flex LED light with the tip of your finger.

**288 W**  
**24 V**



**PILOTdrive-1**  
Monochrome ribbon controller  
3 x 4A - 12-24V - 12A max.

Code : H10560      45€ incl. VAT



Function:  
- Dimmer 5% to 100% monochrome  
- Direct access to a recorded scene  
- «30S» Extinction of the ribbon after 30 seconds  
Power supply: 12 - 24V DC  
Intensity (Max load in amperes) :  
4A x 3 (outputs) = 12A max  
Dimensions: 86 x 86 x 36 mm  
Weight: 208 g  
Compatible with PILOTdrive and PILOTctl

**192W**  
**24 V**



**PILOTdrive-2**  
Controller for warm and cold white ribbons  
2 x 4A - 12 - 24V - 8A max.

Code : H10561      45€ incl. VAT



Function:  
- Dimmer 5% to 100% warm/cold white  
- Direct access to a recorded scene  
- "Mode" to switch between hot and cold  
Power supply: 12 - 24V DC  
Intensity (Max load in amperes) :  
4A x 2 (outputs) = 8A max  
Dimensions: 86 x 86 x 36 mm  
Weight: 208 g  
Compatible with PILOTdrive and PILOTctl

**288 W**  
**24 V**



**PILOTdrive-3**  
RGB ribbon controller  
3 x 4A - 12-24V - 12A max.

Code : H10562      49€ incl. VAT



Function:  
- Dimmer 5 % to 100 % RGB  
- Direct access to a recorded scene  
- 11 modes (fixed + step + fade colours)  
Power supply: 12 - 24V DC  
Intensity (Max load in amperes) :  
4A x 3 (outputs) = 12A max  
Dimensions: 86 x 86 x 36 mm  
Weight: 208 g  
Compatible with PILOTdrive and PILOTctl

**384 W**  
**24 V**



**PILOTdrive-4**  
RGBW ribbon controller  
4 x 4A - 12-24V - 16A max.

Code : H10563      55€ incl. VAT



Function:  
- Dimmer 5% to 100% RGBW  
- Direct access to a recorded scene  
- 12 modes- Direct access to white (fixed + step + fade colours)  
Power supply: 12 - 24V DC  
Intensity (Max load in amperes) :  
4A x 4 (outputs) = 16A max  
Dimensions: 86 x 86 x 36 mm  
Weight: 208 g  
Compatible with PILOTdrive and PILOTctl

**2,4 GHz** **DMX**  
**1 CH**



**PILOTctl-1**  
DMX controller + 2,4 GHz -1 zone - 1 colour

Code : H10564      59€ incl. VAT



Function:  
- Dimmer 5% to 100% monochrome  
- Direct access to a recorded scene  
- «30S» Extinction of the ribbon after 30 seconds  
Power supply: 240V  
Output signal: 2,4 Ghz & DMX512  
Operating distance: 30m and 2.4 Ghz  
Dimensions: 112 x 112 x 48 mm  
Weight: 225 g  
Compatible with PILOTdrive and PILOTctl

**2,4 GHz** **DMX**  
**2 CH**



**PILOTctl-2**  
DMX controller + 2,4 GHz -1 zone - 2 colours

Code : H10565      65€ incl. VAT



Function:  
- Dimmer 5% to 100% warm/cold white  
- Direct access to a recorded scene  
"Mode" to switch between warm and cold white  
Power supply: 240V  
Output signal: 2,4 Ghz & DMX512  
Operating distance: 30m and 2.4 Ghz  
Dimensions: 112 x 112 x 48 mm  
Weight: 225 g  
Compatible with PILOTdrive and PILOTctl

**2,4 GHz** **DMX**  
**3 CH**



**PILOTctl-3**  
DMX controller + 2,4 GHz -1 zone - 3 colours

Code : H10566      75€ incl. VAT



Function:  
- Dimmer 5 % to 100 % RGB  
- Direct access to a recorded scene  
- 11 modes (fixed + step + fade colours)  
Power supply: 240V  
Output signal: 2,4 Ghz & DMX512  
Operating distance: 30m and 2.4 Ghz  
Dimensions: 112 x 112 x 48 mm  
Weight: 225 g  
Compatible with PILOTdrive and PILOTctl

**2,4 GHz** **DMX**  
**4 CH**



**PILOTctl-4**  
DMX controller + 2,4 GHz -1 zone - 4 colours

Code : H10567      75€ incl. VAT



Function:  
- Dimmer 5% to 100% RGBW  
- Direct access to a recorded scene  
- 12 modes (fixed + step + fade colours)  
- Direct access to white on 4 zones  
Power supply: 240V  
Output signal: 2,4 Ghz & DMX512  
Operating distance: 30m and 2.4 Ghz  
Dimensions: 112 x 112 x 48 mm  
Weight: 225 g  
Compatible with PILOTdrive and PILOTctl

**4 ZONES** **2,4 GHz** **DMX 4x4 CH**



**PILOTctl-16**  
DMX Controller + 2,4 GHz  
4 zones - 4 colours per zone

Code : H10568      85€ incl. VAT



Function

- Dimmer 5% to 100% RGBW
- Direct access to a recorded scene
- 12 modes (fixed colour + step + fade colours)
- Direct access to white

Power supply: 240V  
Output signal: 2.4 Ghz & DMX512  
Operating distance: 30m and 2.4 Ghz  
Dimensions: 112 x 112 x 48 mm  
Weight: 225 g  
Compatible with PILOTdrive and PILOTctl

**Wi-Fi** **2,4 GHz** **RGBW**



**TAPElive4**  
Wi-Fi transmitter receiver for driver  
TAPEDRIVER-WIFI4 2.4 GHz remote control

Code : H10572      259€ incl. VAT



Mode of communication: 2.4GHz Wi-Fi, 802.11b/g/n protocol  
Power supply: 12-24V DC  
Operating distance: Approx. 100m  
Intensity: 4A x 4 (outputs) = 16A max  
Power rating: 192W / 384W (12V / 24V)  
Dimensions: 128 x 73 x 45 mm  
Weight: 382 g

Remote Control 2.4GHz included

**2,4 GHz** **4 CH**



**TAPEDRIVER-WIFI4**  
2.4GHz wi-Fi Controller  
4 channels - 5-24VDC - 4 x 5A max.

Code : H10580      85€ incl. VAT



Mode of communication: 2.4GHz Wi-Fi  
Power supply: 5 - 24V DC  
Operating distance: 30m with its remote control  
Intensity: 5A x 4 (outputs) = 20A max  
Power rating: 100W / 240W / 480W (5V / 12V / 24V)  
Dimensions: 175 x 44 x 30 mm  
Weight: 150 g



**POSSIBLE CONFIGURATIONS**

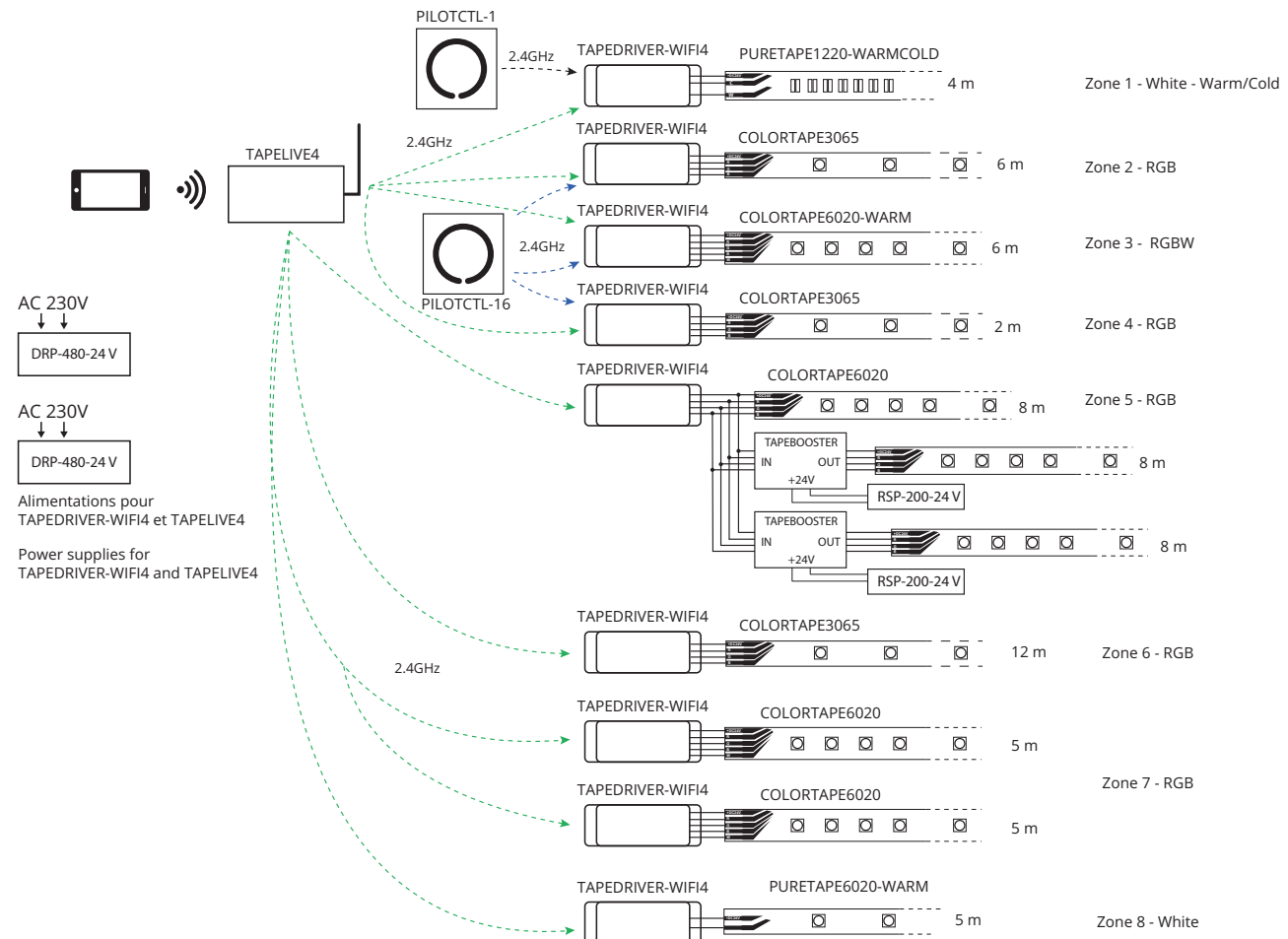

# DRIVERS

2,4 GHz 3 CH



**TAPEDRIVER-RF3**  
2.4GHz Controller  
3 channels - 5-24VDC 3 x 3A max.

Code : H10577 85€ incl. VAT



Mode of communication: 2.4GHz  
Power supply: 5 - 24V DC  
Intensity (max charge in amperes) :  
6A x 3 (outputs) = 18A max  
Power rating: 90W / 216W / 432W  
(5V / 12V / 24V)  
Compatible remote control :  
REMOTERF-8W & REMOTERF-10RGB  
Operating distance: 30m  
Dimensions: 175 x 44 x 30 mm  
Weight: 150 g

2,4 GHz RGB



**TAPEDRIVERTOUCH-RF3**  
Manual controller and 2.4GHz  
3 channels - 12-24V DC - 3x 5A max.

Code : H10578 85€ incl. VAT



Mode of communication: 2.4GHz or manual  
Power supply: 12 - 24V DC  
Intensity (max charge in amperes) :  
5A x 3 (outputs) = 15A max  
Power rating: 180 W / 360 W (12 V / 24 V)  
Compatible remote control :  
REMOTERF-10RGB  
Operating distance: 30m  
Dimensions: 211 x 40 x 30  
Weight: 180 g

2,4 GHz 4 CH



**TAPEDRIVER-RF4**  
2.4GHz Controller  
4 channels - 5-24VDC - 4 x 5A max.

Code : H10579 99€ incl. VAT



Mode of communication: 2.4GHz  
Power supply: 5 - 24V DC  
Intensity (max charge in amperes) :  
5A x 4 (outputs) = 20A max  
Power rating: 100 W / 240 W / 480 W  
(5 V / 12 V / 24 V)  
Compatible remote control :  
REMOTERF-8RGBW  
Operating distance: 30m  
Dimensions: 175 x 44 x 30 mm  
Weight: 150 g

8 zones  
WHITE



**REMOTERF-8W**  
2.4GHz remote controller  
8 zones - 1 colour

Code : H10569 85€ incl. VAT



Mode of communication: 2.4GHz  
Power supply: DC 5V (Lithium) - Mini  
USB rechargeable battery  
Number of controlled zones: 8 zones  
Driver pilot: TAPEDRIVER-RF3  
Operating distance: 30m

10 zones  
RGB



**REMOTERF-10RGB**  
2.4GHz remote controller  
10 zones - 3 colours

Code : H10570 119€ incl. VAT



Mode of communication: 2.4GHz  
Power supply: DC 5V (Lithium) - Mini  
USB rechargeable battery  
Number of controlled zones: 10 zones  
- Direct access to a recorded scene  
- 11 modes (fixed + step + fade colours)  
Driver pilot: TAPEDRIVER-RF3 and  
TAPEDRIVERTOUCH-RF3  
Operating distance: 30m

8 zones  
RGBW



**REMOTERF-8RGBW**  
2.4GHz remote controller  
8 zones - 4 colours

Code : H10571 129€ incl. VAT



Mode of communication: 2.4GHz  
Power supply: DC 5V (Lithium) - Mini  
USB rechargeable battery  
Number of controlled zones: 8 zones  
- Direct access to a recorded scene  
- 12 modes (fixed + step + fade colours)  
- Ability to create a scene  
Driver pilot: TAPEDRIVER-RF4  
Operating distance: 30m



### NO WIRING BETWEEN THE DRIVERS



Our drivers are not wired together. The information sent by the remote control automatically synchronizes with the drivers thanks to the 2.4GHz Wi-Fi technology.



The TAPEDRIVER-RF4 is a 4-channel ribbon controller operated by the REMOTERF-8RGBW remote control. It receives information from the remote control and generates power for RGBW LED ribbons. (480W Max in 24V)

Its RGB and W LEDs will make it easier to check your installations.

### POSSIBLE CONFIGURATIONS

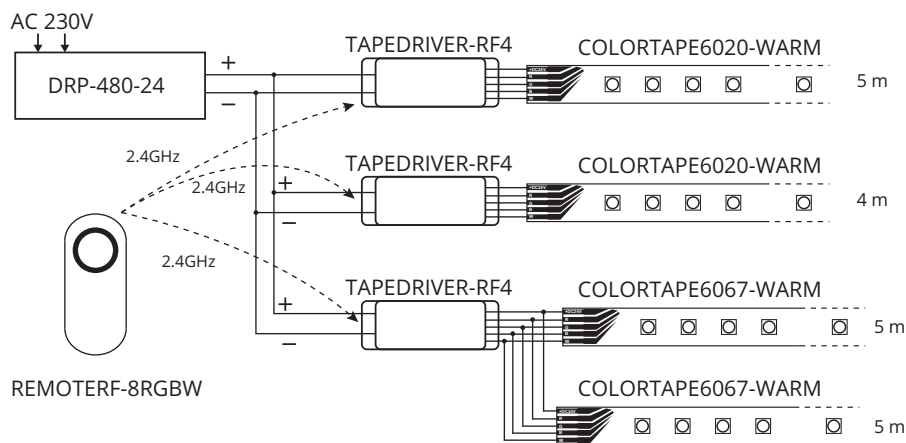

# DMX DRIVERS

Compatible with the COLOURTAPE and PURETAPE ranges, these modules convert your DMX or manual instructions into a power signal for your ribbons.

Assignable and equipped with a DMX input and output, they integrate perfectly into your installation. Combined with a suitable power supply, they can optionally control one monochrome ribbon, one RGB strip or three monochrome ribbons, one RGBW ribbon or four monochrome ribbons.



## TAPEDRIVER-1

DMX controller for ribbons  
1 channel - 12-24VDC - 6A max.

Code : H10573 49€ incl. VAT



For monochrome ribbon  
DMX 1 channel  
144W under 24V  
Dimmer by dip-switches  
Command in 0-10V control



## TAPEDRIVER

DMX/Power converter  
24V - 96 Watts max

Code : H9867 55€ incl. VAT



For monochrome and RGB ribbon  
DMX 3 channels  
96 W under 24 V  
Dimmer by dip-switches



## TAPEDRIVER-3

DMX controller for ribbons  
3 channels - 12-24VDC - 3 x 2A max.

Code : H10574 59€ incl. VAT



For RGB ribbon  
DMX 3 channels  
144W under 24V  
Choice of programs and colours by dip-switches



## LED DMX-CONTROL SCREW

DMX LED 12V DC / 24V DC Controller

Code : B05394 29,90€ incl. VAT



For monochrome and RGB ribbon  
DMX 4 channels  
60 W/ channel = 180 W under 12 VDC  
120 W/ channel = 360 W under 24 VDC  
Choice of programs and colours by dip-switches



## TAPEDRIVER-4

DMX controller for ribbons  
4 channels - 12-24VDC - 4 x 2.5A max.

Code : H10575 85€ incl. VAT



For RGBW ribbon  
DMX 4 channels  
240 W under 24 V  
Choice of programs and colours by dip-switches



## TAPEDRIVER-12

DMX controller for ribbons  
12 channels - 12-24VDC - 12 x 5A max.

Code : H10576 199€ incl. VAT



For all types of 24V ribbons  
DMX 12 channels  
1440 W under 24 V



## DMX OPERATION

Example for a RGB ribbon  
(3 channels)

Channel 1 : Red  
Dimmer 0%-100%

Channel 2 : Green  
Dimmer 0%-100%

Channel 3 : Blue  
Dimmer 0%-100%





### TAPEDIMMER

Dimmer for monochrome ribbon  
24V - 432 Watts maximum

Code : H9866

49€ incl. VAT



Compatible with monochrome ribbons  
Rotary potentiometer to adjust the output level  
Power supply: 24 V DC  
Maximum power: 432W in 24V -  
Dimensions: 112 x 65 x 24 mm  
Weight: 0.5 Kg



### LED 1CH DIM WALL

12V / 24V Wall dimmer

Code : B05392

10,90€ incl. VAT



Compatible with monochrome ribbons  
Rotary potentiometer to adjust the output level  
IR remote control for M/A, standby, dimmer, 4 levels.  
Power supply: 12 or 24V DC  
Maximum power: 160W in 24V - 80W in 12V  
Dimensions: 87 x 87 x 53 mm (box)  
Weight: 0.150 Kg



### LED 1CH DIM-CONTROL

1 12V / 24V channel dimmer

Code : B05393

5,90€ incl. VAT



Compatible with monochrome ribbons  
Rotary potentiometer to adjust the output level  
Power supply: 12 or 24V DC  
Maximum power: 160W in 24V - 80W in 12V  
Dimensions: 89 x 59 x 50 mm  
Weight: 0.065 Kg



### TAPEBOOSTER-RGBW

Compatible with 4-colour, 3-colour and monochrome ribbons, this signal booster increases the number of ribbons connected to a serial controller.

Combined with a suitable power supply, it amplifies the received signal and allows you to connect more ribbons to the same controller for longer hose lengths without discontinuity or difference in brightness.

### POSSIBLE CONFIGURATIONS

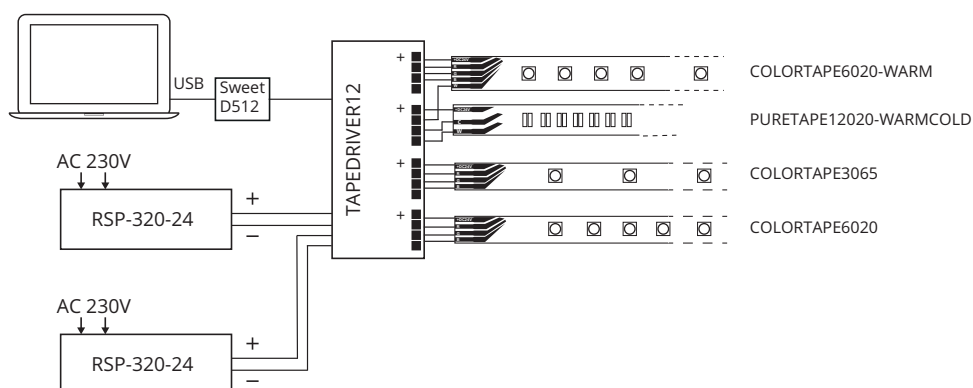

# BOOSTERS AND MANAGERS



## TAPEBOOSTER

RGB signal amplifier  
24V - 576 Watts maximum

Code : H9865 29€ incl. VAT



Compatible with 3-colour and monochrome ribbons  
Supply voltage: DC 24V  
Maximum output load: 3x8A  
Output signal: MLI constant voltage  
Maximum output power: 576W(24V)  
Dimensions: 107 x 65 x 24 mm  
Weight: 0.5 kg



## TAPEBOOSTER-1X10A

1 channel booster - 12-24V DC - 10A max

Code : H10769 45€ incl. VAT



Compatible with monochrome ribbons  
Supply voltage: DC12V-24V  
Maximum output load: 10A/CHx1  
Output signal: MLI constant voltage  
Maximum output power: 120W(12V) / 240W(24V)  
Dimensions: 125 x 45 x H36 mm  
Weight: 0.100 kg



## TAPEBOOSTER-RGBW

4 channel booster - 5-24V DC  
3 x 3A + 1 x 9A max.

Code : H10770 79€ incl. VAT



Compatible with 4-colour, 3-colour and monochrome ribbons  
Supply voltage : DC5V-DC24 V  
Maximum output load:  
- RGB : 3Ax3CH  
- W : 9Ax1CH  
Output signal: MLI constant voltage  
Maximum output power:  
- RGB : 72Wx3CH  
- W : 216W(24V)  
Dimensions: 176 x 46 x 30 mm  
Weight: 0.145 kg



## LED REPEATER

LED-REPEATER RVB

Code : B05400 19€ incl. VAT



Compatible with 3-colour and monochrome ribbons  
Supply voltage : DC12-24 V  
Output signal: MLI constant voltage  
Maximum output power:  
- RGB : 80Wx3CH under 12V  
- RGB : 160Wx3CH under 24V  
Dimensions: 90 x 90 x 24 mm  
Weight: 0.190 kg



## POWTAPE

Control and power box  
24V - 50W - Auto/DMX

Code : H9583 149€ incl. VAT



Compatible with 3-colour and monochrome ribbons  
Integrated power supply: DC24 V  
Maximum output power:  
- RGB : 16Wx3CH total 50W  
Integrated switch controller for:  
Master/Slave, Colours, Musical, Programs.  
4-channel DMX operation  
CTLTAPE Wall Controller Connection.  
Power supply: AC230V - 50 Hz  
Dimensions: 332 x 70 x 40 mm  
Weight: 1kg



## CTLTAPE

Built-in DMX wall-mounted controller  
4 channels - 2 program memories

Code : H9584 55€ incl. VAT



Compatible with 3-colour and monochrome ribbons:  
Colour adjustment by potentiometer (with access to a fade program)  
Adjustment of brightness/strobe by potentiometer  
Setting the speed in Fade mode  
2 adjustment memories  
1 bouton Black Out (ON/OFF)  
DMX 4 channels:  
Red, Green, Blue, General/Strobe Dimmer  
Power supply: DC12V - 1A (not provided)  
Dimensions: 84 x 83 x 40 mm  
Weight: 0.5 kg



## POW121

Controller power supply  
220V/12 V - 1A

Code : H9806 12€ incl. VAT



Power supply for CTLTAPE  
Power supply: AC 240V - 50-60Hz  
Output: 12V DC - 1A  
Protection IP20



## MINI LED MANAGER Mk3

LED DMX Power supply 100W 24V cv

Code : B04949 144,90€ incl. VAT



Compatible with 3-colour and monochrome ribbons  
Integrated power supply: DC24 V  
Maximum output power:  
- RGB : 33Wx3CH total 100W  
Integrated switch controller for:  
Master/Slave, 16 Colours, Musical, programs.  
4-channel DMX operation  
Connection CTLTAPE between wall controller and ON / OFF switch  
Power supply: AC230V - 50 Hz  
Dimensions: 356 x 132 x 43 mm  
Weight: 1.9 kg



### MICRO LED MANAGER Mk2

LED DMX Power supply 50W 24V cv

Code : B04950

99€ incl. VAT



Compatible with 3-colour and monochrome ribbons  
 Integrated power supply: DC24 V  
 Maximum output power:  
 - RGB : 16Wx3CH total 50W  
 Integrated switch controller for:  
 Master/Slave, 16 Colours, Musical, programs.  
 4-channel DMX operation  
 Connection CTLTAPE between wall controller and ON / OFF switch  
 Power supply: AC230V - 50 Hz  
 Dimensions: 332 x 70 x 40 mm  
 Weight: 0.950 kg



### LED WALL DIMMER

Compact RGB remote control for LED projectors

Code : B04936

59€ incl. VAT



Compatible with 3-colour and monochrome ribbons:  
 Colour adjustment by potentiometer (with access to a fade program)  
 Adjustment of brightness/strobe by potentiometer  
 Setting the speed in Fade mode  
 2 adjustment memories  
 1 bouton Black Out (ON/OFF)  
 DMX 4 channels:  
 Red, Green, Blue, General/Strobe Dimmer  
 Power supply: DC12V - 1A (not provided)  
 Dimensions: 84 x 83 x 40 mm  
 Weight: 0.5 kg



### LED RF-CONTROL DIM

1 channel single colour LED controller

Code : B05396

32,90€ incl. VAT



Compatible with monochrome ribbons  
 Power: DC12-24 V  
 Maximum output power:  
 - 240 W under 12 V  
 - 480 W under 24 V  
 HF remote control (433.92 MHz) integrated for:  
 M/A, stop 30s, dimmer, levels, night light  
 RJ45 connection for Master/Slave synchronization  
 Dimensions: 90 x 90 x 24 mm  
 Weight: 0.250 kg



### LED RF-CONTROL RGB

3-channel RGB controller

Code : B05397

32,90€ incl. VAT



Compatible with tricolour ribbons  
 Power: DC12-24 V  
 Maximum output power:  
 - 240 W under 12 V  
 - 480 W under 24 V  
 HF remote control (433.92 MHz) integrated for:  
 M/A, stop 30s, dimmer, levels, night light  
 RJ45 connection for Master/Slave synchronization  
 Dimensions: 90 x 90 x 24 mm  
 Weight: 0.250 kg

## POSSIBLE CONFIGURATIONS

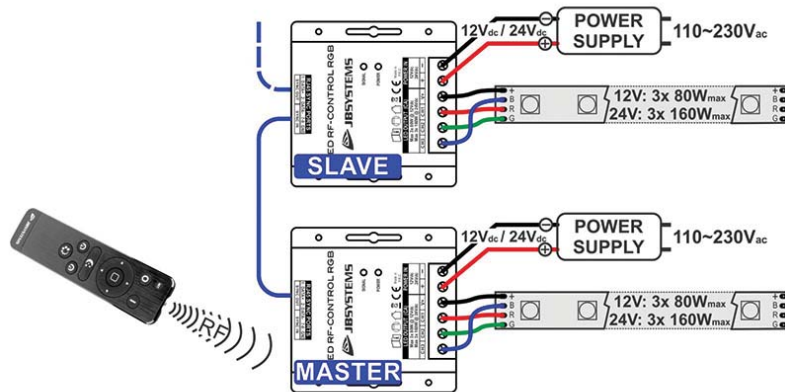

# POWER SUPPLIES

**A**



**POW2411P**  
Waterproof power supply for ribbon  
24V DC - 30 Watts maximum

Code : H9881      19€ incl. VAT

**Contest** 

**B**



**EIP 060V0240LS**  
Switching power supply - 24Vdc/60W

Code : B05390      32,90€ incl. VAT

**JBSYSTEMS**

**C**



**POW242**  
Power supply  
24V - 50 Watts max - IP20

Code : H9807      32€ incl. VAT

**Contest** 

**D**



**POW244IP2**  
Power supply 24VDC 4.15A  
100W max - IP65 - 2 outputs

Code : H10362      75€ incl. VAT

**Contest** 

**E**



**LRS-100-24**  
Power supply 24VDC  
100W max. IP20 - 2 outputs

Code : H10581      42€ incl. VAT

**Contest** 

**F**



**DR120-24**  
Power supply MW  
120W Stabilized, for DIN rail

Code : H9926      139€ incl. VAT

**Contest** 

**NEW** **G**



**ESE 150-24S**  
Switching power supply - 24Vdc/150W

Code : B05398      49€ incl. VAT

**JBSYSTEMS**

**H**



**POW246IP2**  
Power supply 24VDC 6.25A  
150W max - IP65 - 2 outputs

Code : H10316      79€ incl. VAT

**Contest** 

**I**



**RSP-200-24**  
Power supply 24VDC  
200W max. IP20 - 3 outputs

Code : H10582      139€ incl. VAT

**Contest** 

**J**



**DRP240-24**  
Power supply MW  
240W Stabilized, for DIN rail

Code : H9927      199€ incl. VAT

**Contest** 

**K**



**RSP-320-24**  
Power supply 24VDC  
320W max. IP20 - 3 outputs

Code : H10583      139€ incl. VAT

**Contest** 

**L**



**DRP480-24**  
Power supply MW  
480W Stabilized, for DIN rail

Code : H9928      349€ incl. VAT

**Contest** 

	Reference	Code	Output voltage	Intensity	Power	Number of outputs	Format	IP	Dimensions
A	POW241IP	H9881	24V	1 A	30 W	1	-	IP65	218 x 30 x 22
B	EIP 060V0240LS	B05390		2.5 A	60W	1	-	IP20	157 x 54 x 36
C	POW242	H9807		2.1 A	50 W	1	-	IP20	125 x 52 x 36
D	POW244IP2	H10362		4 A	100 W	2	-	IP65	240 x 68 x 57
E	LRS-100-24	H10581		4.5A	100 W	2	A integrate	IP20	129 x 97 x 30
F	DR120-24	H9926		5 A	120 W	2	Rail	IP20	65.5 x 125.2 x 100
G	ESE 150-24S	B05398		6.25 A	150 W	2	A integrate	IP20	159 x 97 x 30
H	POW246IP2	10316		6.5 A	150 W	2	-	IP65	240 x 68 x 57
I	RSP-200-24	10582		8.4 A	200 W	3	A integrate	IP20	215 x 115 x 30
J	DRP-240-24	9927		10 A	240 W	2	Rail	IP20	125.5 x 125.2 x 100
K	RSP-320-24	10583		13.4 A	320 W	3	A integrate	IP20	215 x 115 x 3
L	DRP-480-24	9928		20 A	480 W	2	Rail	IP20	227x125,2x100

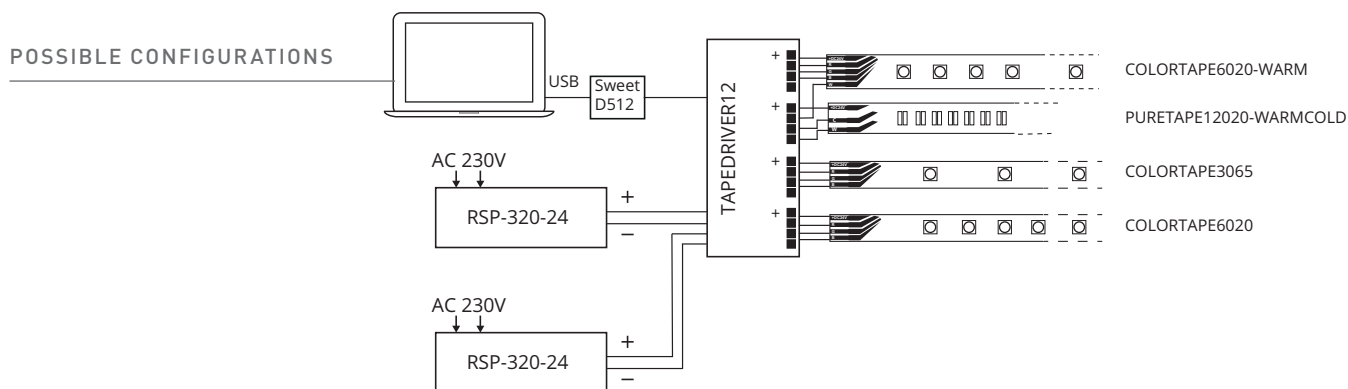

## HOW TO CHOOSE A POWER SUPPLY?

What is the consumption of a ribbon in W and which power supply should I choose?

### Example:

9m of RGB ribbon with 60 LEDs/m 14.4 W/m in 24 V (COLOURTAPE6065)

Consumption of a length L of ribbon (in W) = length (m) x power/meter (w/m)

The ribbon will consume  $14.4 \times 9 = 129.6$  W

### Power supply choice:

An additional 10% of power must be added to the power supply.

In the same example:

$129.6 + 10\% = 142.56$  W

POW246IP2 which is 150W

## WHAT LENGTH OF RIBBON?

The maximum ribbon length is not determined solely by the power of the power supply and the driver. It is also determined by the current intensity that can be supported by the ribbon circuit. You will be able to double the maximum length referenced in the table below by powering the ribbon at both ends.

		Max Length
9859	COLOURTAPE3065	16 m
10541	COLOURTAPE6020	8 m
10542	COLOURTAPE6020-WARM	5 m
9994	COLOURTAPE6065	8 m
9860	COLOURTAPE6067	8 m
10543	COLOURTAPE6067-WARM	5 m
10539	PURETAPE12020-WARMCOLD	5 m
10540	PURETAPE12067-WARMCOLD	5 m
10538	PURETAPE14420-COLD	5 m
10536	PURETAPE14420-WARM	5 m
10537	PURETAPE6020-COLD	8 m
10535	PURETAPE6020-WARM	8 m
9862	PURETAPE6067-COLD	8 m
9861	PURETAPE6067-WARM	8 m

# ALUMINUM PROFILES

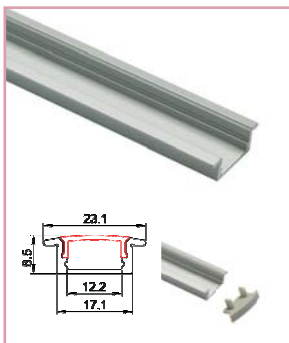

**TAPEprofil-A**  
Built-in aluminum profile 8.5 x 23 mm  
2m Length

Code : H10619 19€ incl. VAT

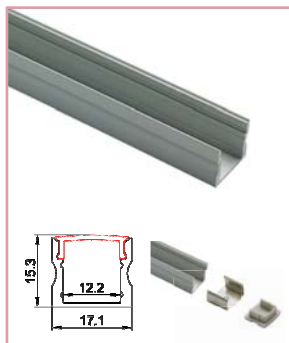

**TAPEprofil-B**  
Aluminium profile 15 x 17 mm  
2m Length

Code : H10620 22€ incl. VAT

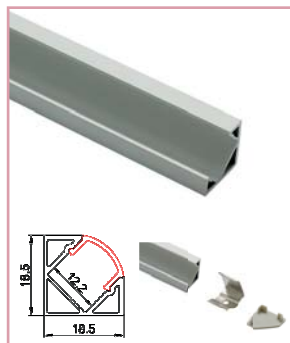

**TAPEprofil-C**  
Aluminium profile 19 x 19 mm 45°  
2m Length

Code : H10621 25€ incl. VAT



**TAPEprofil-D**  
Double width aluminum profile 15 x 24 mm  
2m Length

Code : H10622 35€ incl. VAT

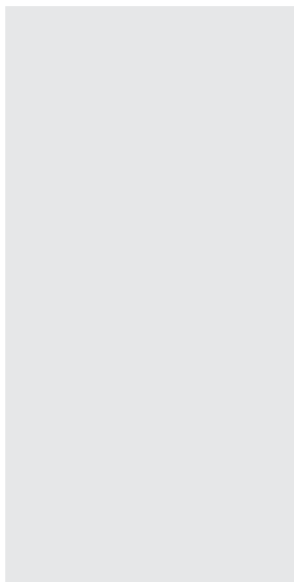

**TAPEclip-B**  
Fastening clip for B profile

Code : H10633 1,70€ incl. VAT



**TAPEclip-C**  
Fastening clip for C profile

Code : H10634 0,80€ incl. VAT



**TAPEclip-D**  
Fastening clip for D profile

Code : H10635 1,10€ incl. VAT



**TAPEcaps-A**  
Termination cap for profile A

Code : H10629 0,80€ incl. VAT



**TAPEcaps-B**  
Termination cap for profile B

Code : H10630 0,80€ incl. VAT



**TAPEcaps-C**  
Termination cap for profile C

Code : H10631 0,80€ incl. VAT



**TAPEcaps-D**  
Termination cap for profile D

Code : H10632 0,80€ incl. VAT





**TAPEcov-1**  
Crystal diffuser for profiles A,B,C  
2m Length

Code : H10623 14€ incl. VAT

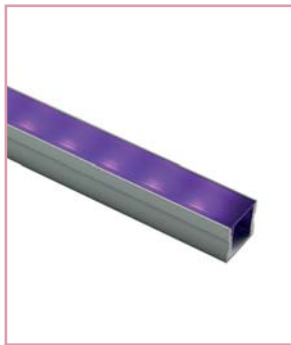

**TAPEcov-2**  
Frost diffuser for profiles A,B,C  
2m Length

Code : H10624 14€ incl. VAT

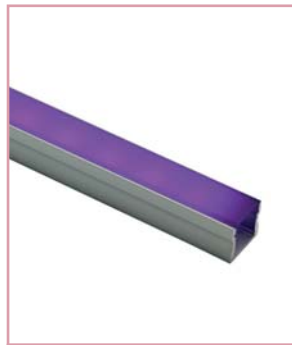

**TAPEcov-3**  
Milk diffuser for profiles A,B,C  
2m Length

Code : H10625 14€ incl. VAT

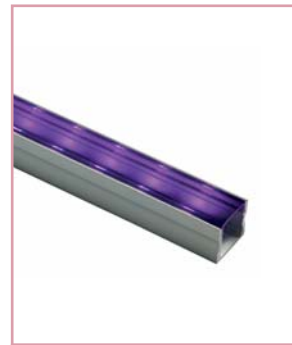

**TAPEcov-4**  
Crystal diffuser for profile D  
2m Length

Code : H10626 19€ incl. VAT

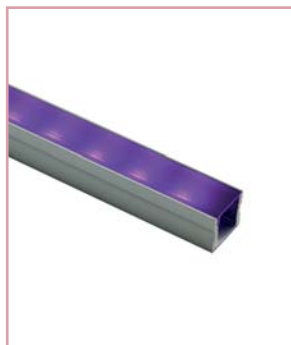

**TAPEcov-5**  
Frost diffuser for profile D  
2m Length

Code : H10627 19€ incl. VAT

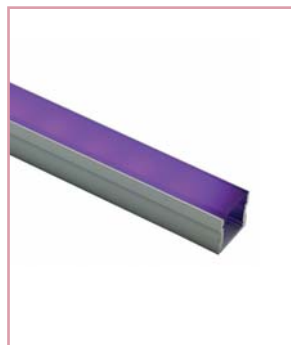

**TAPEcov-6**  
Milk diffuser for profile D  
2m Length

Code : H10628 19€ incl. VAT



**ALU-CORNER-15MM (2M)**  
Corner profile

Code : B05376 24,90€ incl. VAT



**ALU-RECESS-15MM (2M)**  
Built-in high profile

Code : B05371 29,90€ incl. VAT



**ALU-SURFACE-7MM (2M)**  
Low profile

Code : B05372 25,90€ incl. VAT



**ALU-SURFACE-15MM (2M)**  
High profile

Code : B05374 30,90€ incl. VAT



**THE TYPES OF LIGHT DIFFUSION**

**Milk - Opaline diffuser**  
Diffusion, it makes it possible to make signage. You do not see the LEDs

**Frost - 50% diffusing**  
Ambient lighting. It diffuses the light (if the chosen profile is deep enough).

**Crystal - Transparent**  
For lighting, it protects LEDs  
Using the cover will attenuate the brightness of the ribbon according to its opacity.



# ACCESSORIES FOR RIBBONS



**TCO-2**  
T connector for 10 mm monochrome ribbons

Code : H10549      0.60€ incl. VAT

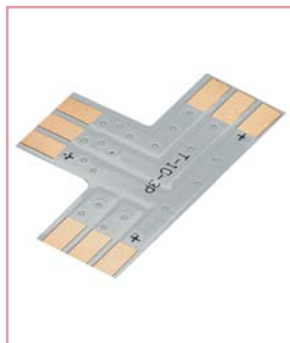

**TCO-3**  
T connector for 2-colour 10 mm ribbons

Code : H10552      0.80€ incl. VAT



**TCO-4**  
T connector for 10 mm 3-colour ribbons

Code : H10555      0.80€ incl. VAT



**TCO-5**  
T connector for 12 mm 4-colour ribbons

Code : H10558      1€ incl. VAT

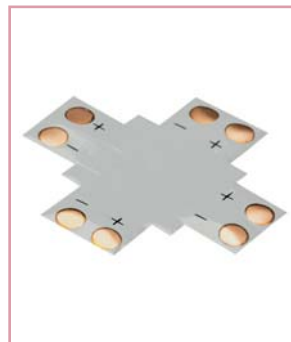

**XCO-2**  
X connector for 10 mm monochrome ribbons

Code : H10550      0.70€ incl. VAT

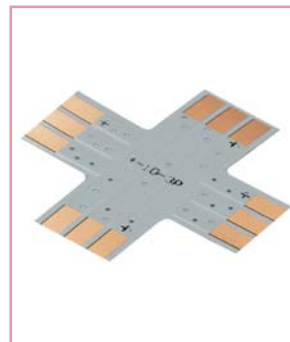

**XCO-3**  
X connector for 2-colour ribbons 10 mm

Code : H10553      1€ incl. VAT

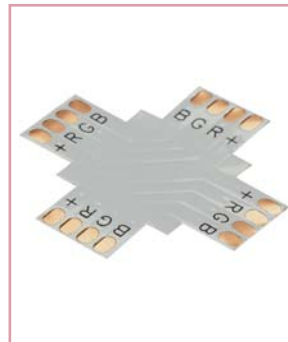

**XCO-4**  
X connector for 10 mm 3-colour ribbons

Code : H10556      0.90€ incl. VAT

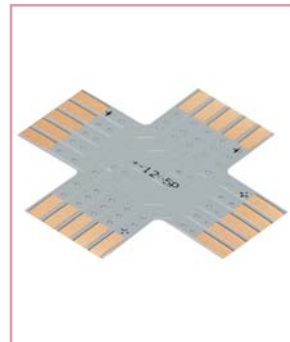

**XCO-5**  
X connector for 12 mm 4-colour ribbons

Code : H10559      1€ incl. VAT



**LCO-2**  
L-connector for 10 mm monochrome ribbons

Code : H10548      0.80€ incl. VAT

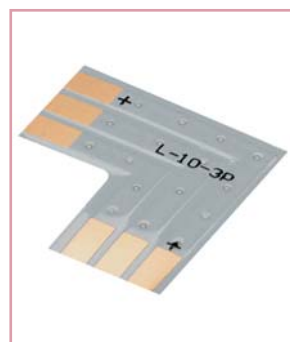

**LCO-3**  
L-connector for 2-colour ribbons 10 mm

Code : H10551      0.80€ incl. VAT



**LCO-4**  
L-connector for 10 mm 3-colour ribbons

Code : H10554      0.80€ incl. VAT

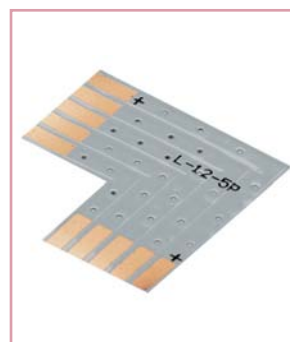

**LCO-5**  
L-connector for 12 mm 4-colour ribbons

Code : H10557      0.80€ incl. VAT





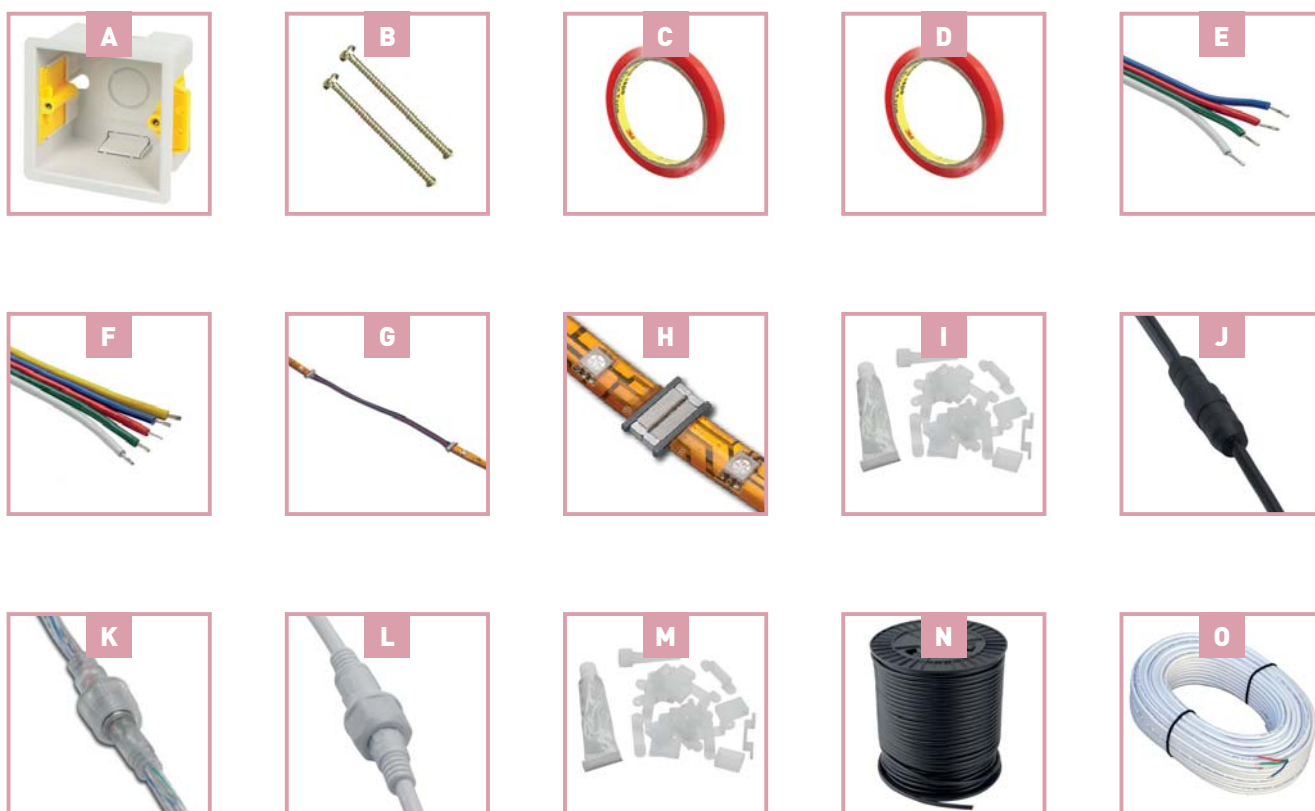

A	H10637	PILOTBOX - Recessed square box 47 mm white	CONTEST®	9€ incl. VAT
B	H10638	PILOTSCREW - Screw steel size M3.5x20 - 1 piece (2 are needed by PILOTBOX)	CONTEST®	0,50€ incl. VAT
C	H10544	ADF1050 - Double sided adhesive width 10 mm - roll of 50 m	CONTEST®	42€ incl. VAT
D	H10545	ADF1250 - Double sided adhesive width 12 mm - roll of 50 m	CONTEST®	49€ incl. VAT
E	H10546	FLATCABLE-4 Flat cable 4 x 0.326mm <sup>2</sup> N/G/R/B - 10m	CONTEST®	25€ incl. VAT
F	H10547	FLATCABLE-5 - Flat cable 5 x 0,326mm <sup>2</sup> N/G/R/B/Y- 10m	CONTEST®	29€ incl. VAT
G	H9887	TAPELINK20 - 4-wire cords with F/F-IP20 connectors	CONTEST®	1,40€ incl. VAT
H	H9888	TAPECON4FF - 4-pin connector F / F-IP20 pack of 20	CONTEST®	0,80€ incl. VAT
I	H9883	TAPEFIX65 - Set of 15 bridges, 5 endcaps, 1 Silicone Tube	CONTEST®	4,80€ incl. VAT
J	H9884	TAPELINK61 - 4-wire cords with M/F-IP61 connectors - black	CONTEST®	2,90€ incl. VAT
K	H9885	TAPELINK65 - Connect 4-wire cords. M/F-IP65 - transparent	CONTEST®	5,60€ incl. VAT
L	H9886	TAPELINK68 - 4-wire cords M/F-IP68 connectors - white	CONTEST®	3,50€ incl. VAT
M	H9882	TAPEFIX68 - Set of 15 bridges, 5 endcaps, 1 Silicone Tube	CONTEST®	4,80€ incl. VAT
N	H9808	RGBB-100 - 4-wire electric cable for 3-colour ribbons of 50 meter	CONTEST®	119€ incl. VAT
O	B04944	CCM-50 - Cable to connect LED projectors to the output of our LED drivers	JB SYSTEMS®	99€ incl. VAT

# DECORATION PROJECTORS



## CEIL6TC-MKII

Waterproof projector with 6 LEDs 3 W  
3-colour supplied with mounting bracket.

Code : H10658

149€ incl. VAT



6 RGB LEDs of 3W  
Flux (Lm): 590 +/- 2.5%  
Beam opening angle of 20° - Brightness of 266 Lux at 3 m in white  
Extruded aluminium body  
Convection cooling - IP degree: 65 [total protection against dust and splashing water]  
Power supply: DC12-48V 350 mA (max) /48V  
Consumption: 18 W  
Cable: 1 m Cat.5e with 8-pin RJ45 connector  
Dimensions: Diameter 111 mm  
Length 72 mm (without cable gland) / 92 mm (with cable gland)  
Weight: 0.775 kg



## CEIL3TC-MKII

Outdoor floodlight with 3 3W TRI IP65 LED  
RJ45 connectors

Code : H10492

89€ incl. VAT



3 RGB LEDs of 3W  
Flux (Lm): 210 +/- 2.5%  
Beam opening angle of 40°  
Extruded aluminium body  
Convection cooling  
Compatible with MR16 mounts  
Ingress protection: IP65 [total protection against dust and splashing water]  
Power supply: DC12-48V 350 mA (max) /48V  
Consumption: 12 W  
Cable: 1 m Cat.5e with 8-pin RJ45 connector  
Dimensions: Diameter 49.5 mm [compatible MR16]  
Length 75 mm (without cable gland) / 95 mm (with cable gland)  
Weight: 0.245 kg



## PILOT60

60W control and power supply box  
RJ45 connectors

Code : H9780

199€ incl. VAT



Standalone operation:  
Mode master / Slave  
Automatic  
16 integrated programs  
3 free programs  
Compatible with coloured and white projectors  
DMX operation:  
RGBW projectors: from 3 to 7 channels depending on functions  
White or unicolour spotlights: from 1 to 2 channels depending on the functions  
48V output on RJ45 for projectors up to 60W maximum  
RJ45 / XLR adapter supplied for DMX connections  
Power supply : AC100-240V 50-60Hz  
Dimensions: 179 x 215 x 60 mm  
Net weight: 1.4 kg



## LD-POWER 60

Power unit for LED projectors

Code : B05120

175€ incl. VAT



Standalone operation:  
Mode master / Slave  
Automatic  
16 integrated programs  
3 free programs  
Compatible with colour and white projectors  
DMX operation:  
RGBW projectors: from 3 to 7 channels depending on functions  
White or unicolour spotlights: from 1 to 2 channels depending on the functions  
48V output on RJ45 for projectors up to 60W maximum  
RJ45 / XLR adapter supplied for DMX connections  
Power supply : AC100-240V 50-60Hz  
Dimensions: 179 x 215 x 60 mm  
Net weight: 1.4 kg



## PILOT120

Control and power box  
2 zones 120W - RJ45 connectors

Code : H9781

329€ incl. VAT



Standalone operation:  
Mode master / Slave  
Automatic  
16 integrated programs  
3 free programs  
Compatible with coloured and white projectors  
DMX operation:  
RGBW projectors: from 4 to 11 channels depending on functions  
White or unicolour spotlights: from 2 to 4 channels depending on the functions  
2 x 48V outputs on RJ45 for projectors up to 60W maximum per zone  
RJ45 / XLR adapter supplied for DMX connections  
Power supply : AC100-240V 50-60Hz  
Dimensions: 234 x 279 x 62 mm  
Net weight: 2.4 kg



## PILOT240

Control and power box  
4 zones 240W - RJ45 Connectors

Code : H9782

599€ incl. VAT



Standalone operation:  
Mode master / Slave  
Automatic  
15 integrated programs  
3 free programs + scheduling a calendar  
Compatible with coloured and white projectors  
DMX operation:  
RGBW projectors: from 4 to 19 channels depending on functions  
White or unicolour spotlights: from 4 to 8 channels depending on the functions  
4 x 48V outputs on RJ45 for projectors up to 60W maximum per zone  
RJ45 / XLR adapter supplied for DMX connections  
Power supply : AC100-240V 50-60Hz  
Dimensions: 280 x 309 x 90 mm  
Net weight: 4 kg



## EXPLANATIONS OF THE CALCULATION:

The number of projectors depends on the power consumption in relation to the permissible power supply. The low limit takes into account 30% of the power consumed by the cable. The high limit does not consider the cable consumption.



A	H9786	LINK-RJ15 - RJ45-RJ45 cable - 0.15m	CONTEST®	2,50€ incl. VAT
B	H9787	LINK-RJ50 - RJ45-RJ45 cable - 0.5m	CONTEST®	3€ incl. VAT
C	H9788	LINK-RJ150 - RJ45-RJ45 cable - 1.5m	CONTEST®	3€ incl. VAT
D	H9789	LINK-RJ300 - RJ45-RJ45 cable - 3m	CONTEST®	6,50€ incl. VAT
E	H9790	LINK-RJ500 - RJ45-RJ45 cable - 5m	CONTEST®	13€ incl. VAT
F	H9791	LINK-RJ1000 - RJ45-RJ45 cable - 10m	CONTEST®	14€ incl. VAT
G	H9792	LINK-SPLIT - RJ45 Splitter - To avoid long cable lengths between projectors	CONTEST®	6,50€ incl. VAT
	B05154	LD-SPLIT RJ45 (5pcs) - RJ45 inputs and outputs designed for CAT-5e cables. (5pcs)	BRITEQ®	24,90€ incl. VAT
H	H9793	LINK-END - Termination connector For CEIL1TC, CEIL4TC, CEIL6TC and FLAT1TC projectors	CONTEST®	0,90€ incl. VAT
	B05156	LD-TERM RJ45 (5 pcs) - Small RJ45 connection terminal.	BRITEQ®	3,90€ incl. VAT
I	H9803	LINK-IPBOX - Waterproof junction box with built-in pin connectors	CONTEST®	35€ incl. VAT
	B05155	LD-SPLIT - IP 68 - Plastic junction box - IP68 with inputs and outputs designed for CAT-5e cables	BRITEQ®	29€ incl. VAT
J	H9804	LINK-SOCKET - Male RJ45 connector covers black cable	CONTEST®	1,40€ incl. VAT
K	H9805	LINK-TOOL - Crimping pliers for RJ45 connector	CONTEST®	19€ incl. VAT
L	H9802	CAT5e-100 - Category 5 cable for RJ45 connector - 100m	CONTEST®	169€ incl. VAT
M	B05150	LD-PATCH RJ45 - 0.15M - CAT-5e cables with RJ45 connectors - 0.15M	BRITEQ®	1,39€ incl. VAT
	B05151	LD-PATCH RJ45 - 0.50M - CAT-5e cables with RJ45 connectors - 0.50M	BRITEQ®	2,90€ incl. VAT
	B05152	LD-PATCH RJ45 - 1.50M - CAT-5e cables with RJ45 connectors - 1.50M	BRITEQ®	4,90€ incl. VAT
	B05153	LD-PATCH RJ45 - 5.00M - CAT-5e cables with RJ45 connectors - 5.00M	BRITEQ®	9,90€ incl. VAT

Ribbon type



Monochrome/UV/Blue

W/WW

RGB

RGBW



PILOTdrive-1	H10560	✓	-	-	-
PILOTdrive-2	H10561	-	✓	-	-
PILOTdrive-3	H10562	-	-	✓	-
PILOTdrive-4	H10563	-	-	-	✓
PilotTOUCH	H9809	-	-	✓	-
TAPEDIMMER	H9866	✓	-	-	-
LED 1CH DIM WALL	B05392	✓	-	-	-
LED 1CH DIM-CONTROL	B05393	✓	-	-	-
TAPEDRIVER-1	H10573	✓	-	-	-
LED DMX-CONTROL SCREW	B05394	-	-	✓	-
TAPEDRIVER-3	H10574	✓	✓	✓	-
TAPEDRIVER-4	H10575	✓	✓	✓	✓
TAPEDRIVER-12	H10576	✓	✓	✓	✓
POWTAPE	H9583	-	-	✓	-
MICRO LED MANAGER Mk2	B04936	-	-	✓	-
MINI LED MANAGER Mk3	B04949	-	-	✓	-
TAPEDRIVER-RF3	H10577	✓	-	✓	-
TAPEDRIVERTOUCH-RF3	H10578	-	-	✓	-
TAPEDRIVER-RF4	H10579	-	-	-	✓
TAPEDRIVER-WIFI4	H10580	✓	✓	✓	✓
LED RF-CONTROL DIM	B05396	✓	-	-	-
LED RF-CONTROL RGB	B05397	-	-	✓	-
TAPELIVE4	H10572	✓	✓	✓	✓

	RE MOTERF-8W 10569	RE MOTERF-10RGB 10570	RE MOTERF-8RGBW 10571	PILOTctl-1 10564	PILOTctl-2 10565	PILOTctl-3 10566	PILOTctl-4 10567	PILOTctl-16 10568	Pilot-TOUCH 9809	Téléphone/Tablette	TAPELIVE4 10572	Controleur DMX	CTLTAPE H9584	LED WALL DIMMER B04936	LEDCON-02 MK2 B04660
RE MOTERF-8W 10569	✓	✓													
RE MOTERF-10RGB 10570	✓														
RE MOTERF-8RGBW 10571			✓												
PILOTctl-1 10564				✓											
PILOTctl-2 10565				✓	✓										
PILOTctl-3 10566				✓	✓	✓									
PILOTctl-4 10567				✓	✓	✓	✓								
PILOTctl-16 10568							✓	✓							
Pilot-TOUCH 9809									✓						
Téléphone/Tablette										✓					
TAPELIVE4 10572											✓				
Controleur DMX												✓			
CTLTAPE H9584													✓	✓	✓
LED WALL DIMMER B04936														✓	✓
LEDCON-02 MK2 B04660															✓
TAPEDRIVER-RF3 10577															
TAPEDRIVER TOUCH-RF3 10578		✓													
TAPEDRIVER-RF4 10579			✓												
TAPEDRIVER-WIFI4 10580				✓	✓	✓	✓	✓			✓				
TAPELIVE4 10572										✓					
TAPEDRIVER1 10573				✓								✓			
TAPEDRIVER3 10574					✓	✓			✓			✓			
TAPEDRIVER4 10575							✓	✓				✓			
TAPEDRIVER12 10576												✓			
MINI LED MANAGER MK3 B04949													✓	✓	✓
POWTAPE H9583													✓	✓	✓
MICRO LED MANAGER MK2 B04950														✓	✓





# LIGHTING

ARCHITECTURE PROJECTORS  
AMBIENT PROJECTORS  
BATTERY PROJECTORS  
SCENOGRAPHY PROJECTORS  
FLAT PROJECTORS  
PAR PROJECTORS  
PANELS, BLINDERS AND FLOOD  
MOVING HEADS  
SCANNERS  
ANIMATION EFFECTS  
LASERS  
STROBES  
BLACK LIGHT  
MIRROR BALLS  
CONTROLLERS  
ELECTRICAL DISTRIBUTION



# ARCHITECTURE PROJECTORS

## Designed for installation

The projectors of the IPZOOM, IPSPOT and BT-ColoRay range are equipped with ergonomics perfectly adapted to fixed or temporary installations. Their robust cast aluminium and IP65 housing allow for continuous use outdoors. The air valve avoids condensation and removes moisture from the projector.

The bright OLED or LCD display allows you to visualize & set the different menu options manually. Thanks to the use of touch buttons a waterproof barrier is maintained, without wear of buttons.



## Tight connections

IPZOOM's such as IPSPOT and BT-ColoRay are equipped with inputs and outputs dedicated to the power supply and DMX link. In order to improve discretion and ease of wiring, the IPZOOMs are equipped with waterproof chassis and plugs.

Chassis sealing is ensured by plugs. In addition to the adapters supplied, you will find a whole range of optional cables and plugs in order to make waterproof connections to other products from our range.

**IPZOOM7x15QC**  
Waterproof projector with 7x15W RGBW 4-in-1 LEDs

Code : H10657      649€ incl. VAT

Optics: 7x15W RGBW LEDs  
Zoom opening angle: 12° to 45°  
Integrated control unit with OLED touch panel display with drop-down menu SEETRONIC® DMX IN and OUT 3- and 5-pin plugs with waterproof plug SEETRONIC® POWER IN/OUT 3-pole plugs with waterproof plug Power supply: 100-240V/50-60Hz Power consumption: 130W  
Waterproofing level: IP65  
Natural convection cooling  
Depressurisation valve with waterproof membrane  
Finish: cast aluminium painted black  
Dimensions: 270 x 320 x 320 mm  
Weight: 9.9 kg



**IPZOOM3x15QC**  
Waterproof projector with 3x15W RGBW 4-in-1 LEDs

Code : H10656      399€ incl. VAT

Optics: 3x15W RGBW LEDs  
Zoom opening angle: 12° to 45°  
Integrated control unit with OLED touch panel display with drop-down menu SEETRONIC® DMX IN and OUT with 3- and 5-pin XLR plugs with waterproof plug SEETRONIC® POWER IN/OUT 3-pole plugs with waterproof plug Power supply: 100-240V/50-60Hz Power consumption: 70W  
Waterproofing level: IP65  
Natural convection cooling  
Depressurisation valve with waterproof membrane  
Finish: cast aluminium painted black  
Dimensions: 245 x 250 x 270 mm  
Weight: 5.8 kg



**NEW**

**BT-ColoRay 120R**  
LED proj. 120W RGBW COB 13° RENTAL (IP-POWER)

Code : B05509      439€ incl. VAT

Optics: 1x 120W RGBW COB LED  
Opening angle: 25°  
Integrated control unit with LCD display with drop-down menu DMX IN and OUT with 5-pin XLR plugs with waterproof plug POWER IN/OUT with original NEUTRIK PowerCon® TRUE1 connectors Power supply: 100-240V/50-60Hz Power consumption: 129 W  
Waterproofing level: IP65  
Waterproof fan  
Depressurisation valve with waterproof membrane  
Finish: cast aluminium painted black  
Dimensions: 304 x 188 x 272 mm  
Weight: 4.8 kg



**NEW**



IP65 60W RGBW 25°

**BT-ColoRay 60R**  
LED proj. 60W RGBW 13° RENTAL COB (IP-POWER)

Code : B05510 329€ incl. VAT



Optics: 1x 60W RGBW COB LED  
Opening angle: 25°  
Integrated control unit with LCD display with drop-down menu  
DMX IN and OUT with 5-pin XLR plugs with waterproof plug  
POWER IN/OUT with original NEUTRIK PowerCon® TRUE1 connectors  
Power supply: 100-240V/50-60Hz  
Power consumption: 70 W  
Waterproofing level: IP65  
Waterproof fan  
Depressurisation valve with waterproof membrane  
Finish: cast aluminium painted black  
Dimensions: 304 x 188 x 272 mm  
Weight: 4.8 kg

**NEW**



IP65 120W RGBWA 23°

**IPSPOT12x10FIVE**  
Projector with 12x10W - IP65 FIVE LEDs

Code : H10793 469€ incl. VAT



Optics: 12x10W RGBWA LED  
Opening angle: 23°  
Integrated control unit with LCD display with drop-down menu  
SEETRONIC® DMX IN and OUT 3- and 5-pin plugs with waterproof plug  
SEETRONIC® POWER IN/OUT 3-pole plugs with waterproof plug  
Power supply: 100-240V/50-60Hz  
Power consumption: 125 W  
Waterproofing level: IP65  
Natural convection cooling  
Depressurisation valve with waterproof membrane  
Finish: cast aluminium painted black  
Dimensions: 261 x 240 x 249 mm  
Weight: 9.9 kg



**NEW**



IP65 70W RGBWA 23°

**IPSPOT7x10FIVE**  
Projector with 7x10W - IP65 FIVE LEDs

Code : H10792 329€ incl. VAT



Optics: 7x10W RGBWA LED  
Opening angle: 23°  
Integrated control unit with LCD display with drop-down menu  
SEETRONIC® DMX IN and OUT with 3-pin XLR plugs with waterproof plug  
SEETRONIC® POWER IN/OUT 3-pole plugs with waterproof plug  
Power supply: 100-240V/50-60Hz  
Power consumption: 75 W  
Waterproofing level: IP65  
Natural convection cooling  
Depressurisation valve with waterproof membrane  
Finish: cast aluminium painted black  
Dimensions: 188 x 273 x 282 mm  
Weight: 5.8 kg



Architecture projector connections					Prix
A	H10716	SC3FXX-W - Seetronic female 3P XLR IP65 waterproof plug		SEETRONIC®	8€ incl. VAT
B	H10717	SC3MXX-W - Seetronic male 3P XLR IP65 waterproof plug		SEETRONIC®	6€ incl. VAT
C	H10718	SC5FXX-W - Seetronic female 5P XLR IP65 waterproof plug		SEETRONIC®	9€ incl. VAT
D	H10719	SC5MXX-W - Seetronic male 3P XLR IP65 waterproof plug		SEETRONIC®	8€ incl. VAT
E	H10720	SAC3FX - Seetronic Power In XLR IP65 waterproof plug		SEETRONIC®	8€ incl. VAT
F	H10721	SAC3MX - Seetronic Power Out IP65 waterproof plug		SEETRONIC®	9€ incl. VAT
G	H10722	IPCD-1 - DMX 3P waterproof connection cord - 1m	NEW 2018	HILEC®	15€ incl. VAT
	H10723	IPCD-2 - DMX 3P waterproof connection cord - 2m	NEW 2018	HILEC®	17€ incl. VAT
	H10724	IPCD-5 - DMX 3P waterproof connection cord - 5m	NEW 2018	HILEC®	25€ incl. VAT
H	H10725	IPCP-1 - Waterproof electrical connection cord - 1m	NEW 2018	HILEC®	32€ incl. VAT
	H10726	IPCP-2 - Waterproof electrical connection cord - 2m	NEW 2018	HILEC®	35€ incl. VAT
	H10776	IPCP-3 - Waterproof electrical connection cord - 3m	NEW 2018	HILEC®	37€ incl. VAT
	H10727	IPCP-5 - Waterproof electrical connection cord - 5m	NEW 2018	HILEC®	39€ incl. VAT

# ARCHITECTURE PROJECTORS

At a time when new LED sources compete with traditional lamps, surpassing them in many areas, we offer you a new approach to lighting, focused on the quality of diffused light and easy colour control.



**IP65**



**BT-ULTRAZOOM**  
180W RGBW LED projector with 4°-40° motorised zoom (IP65).

Code : B04396      1159€ incl. VAT



Optics: 1x180W RGBW LED  
Zoom opening angle: 4° to 40°  
Integrated control unit with OLED touch panel display with drop-down menu SEETRONIC® DMX IN and OUT 3- and 5-pin plugs with waterproof plug SEETRONIC®POWER IN/OUT 3-pole plugs with waterproof plug  
Power supply: 100-240V/50-60Hz  
Power consumption: 180W  
Waterproofing level: IP65  
Natural convection cooling  
Depressurisation valve with waterproof membrane  
Finish: cast aluminium painted black  
Dimensions: 250 x 312 x 404 mm  
Weight: 9.15 kg





**IP65**







**BT-SMARTZOOM**  
120W RGBW LED projector with motorised zoom [4° to 36°] (IP65).

Code : B04397      829€ incl. VAT



Optics: 1x120W RGBW LED  
Zoom opening angle: 4° to 36°  
Integrated control unit with OLED touch panel display with drop-down menu SEETRONIC® DMX IN and OUT 3- and 5-pin plugs with waterproof plug SEETRONIC®POWER IN/OUT 3-pole plugs with waterproof plug  
Power supply: 100-240V/50-60Hz  
Power consumption: 130W  
Waterproofing level: IP65  
Natural convection cooling  
Depressurisation valve with waterproof membrane  
Finish: cast aluminium painted black  
Dimensions: 274 x 388 x 210 mm  
Weight: 7.7 kg



**IP66**



**PRO BEAMER ZOOM - RENTAL**  
8° - 40° motorised zoom

Code : B04399      559€ incl. VAT



Optics: 7x12W RGBW LEDs  
Two zones (outer ring + centre)  
Zoom opening angle: 8° to 40°  
Integrated control unit with display with drop-down menu  
SEETRONIC® DMX IN and OUT with 3-pin XLR plugs with waterproof plug SEETRONIC®POWER IN/OUT 3-pole plugs with waterproof plug  
Power supply: 100-240V/50-60Hz  
Power consumption: 128W  
Waterproofing level: IP66  
Natural convection cooling  
Depressurisation valve with waterproof membrane  
Finish: cast aluminium painted black  
Dimensions: 355 x 191 x 236 mm  
Weight: 7.3 kg

**BARN-PRO BEAMER ZOOM**



Code : B04391      49€ incl. VAT



Four-leaf barndoor:  
Compatible with PRO BEAMER ZOOM - RENTAL

**NEW**



**IP65**



**STAGE BEAMER FC - OUTDOOR**  
14x5W RGBW 14° - IP65

Code : B05511      369€ incl. VAT



Optics: 14x5W RGBW LEDs  
Opening angle: 14°  
Integrated control unit with display with drop-down menu  
Waterproof wiring for power supply inputs/outputs and DMX inputs/outputs  
Power supply: 100-240V/50-60Hz  
Power consumption: 65W  
Waterproofing level: IP65  
Natural convection cooling  
Finish: cast aluminium painted black  
Dimensions: 245 x 205 x 245 mm  
Weight: 4.96 kg



Find the power and signal cords on the previous page

**NEW**



**IP20** **14x5W** RGBW **14°**

**STAGE BEAMER FC – INDOOR**  
LED proj. 14x5W RGBW 14°

Code : B05504 369€ incl. VAT



Optics: 14x5W RGBW LEDs  
Opening angle: 14°  
Integrated control unit with display with drop-down menu  
DMX IN / OUT with 3- and 5-pin XLR plugs  
POWER IN/OUT with Powercon plugs  
Power supply: 100-240V/50-60Hz  
Power consumption: 65W  
Natural convection cooling  
Finish: cast aluminium painted black  
Dimensions: 245 x 205 x 245 mm  
Weight: 4.96 kg





**BARN-STAGE BEAMER**  
Stage Beamer barndoor

Code : B04342 59€ incl. VAT

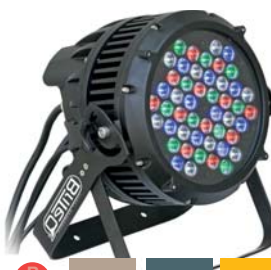

Stage beamer four-leaf barndoor

**IP66** **48x3W** **15°**

**48x3W RGBW MEGA BEAM**  
Mk3 LED

Code : B04395 659€ incl. VAT



Optics: 48x3W LEDs  
12 red, 12 green, 12 blue, 12 white  
Opening angle: 15°  
Integrated control unit with display with drop-down menu  
Waterproof wiring for power supply inputs/outputs and DMX inputs/outputs  
Power supply: 100-240V/50-60Hz  
Power consumption: 180W  
Waterproofing level: IP66  
Natural convection cooling  
Finish: cast aluminium painted black  
Dimensions: 305 x 276 x 230 mm  
Weight: 10.3 kg

**IP65** **7x3W** RGB **16°**

**MINI BEAMER OUT-DOOR**  
RGB LED 7x3W tricolour LEDs.

Code : B04357 249€ incl. VAT



Optics: 7x3W RGB LEDs  
Opening angle: 16°  
Integrated control unit with display with drop-down menu  
Waterproof wiring for power supply inputs/outputs and DMX inputs/outputs  
Power supply: 100-240V/50-60Hz  
Power consumption: 27W  
Waterproofing level: IP65  
Natural convection cooling  
Depressurisation valve with waterproof membrane  
Finish: cast aluminium painted black  
Dimensions: 220 x 175 x 228 mm  
Weight: 5.48 kg

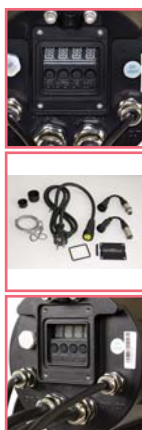



**IP65** **15W** RGB **10°**

**EZ-SPOT15 OUTDOOR**  
15W RGBW LED projector

Code : B05131 99€ incl. VAT

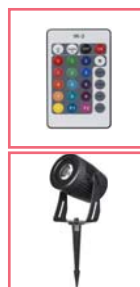

Optics: 1x15W RGBW LED  
Opening angle: 10°  
Infrared remote control IR-3  
Power supply: 100-240V/50-60Hz  
Power consumption: 27W  
Waterproofing level: IP65  
Natural convection cooling  
Finish: cast aluminium painted black  
Dimensions: 152 x 133 x 90 mm  
Weight: 1.31 kg

**IP68** **1W** **10°**

**Nano Beam / Blue LED**  
10° LED projector, IP68, 24V (ac/dc)

Code : B04995 34.90€ incl. VAT



Optics: 1x1W Luxeon LED.  
The electrical consumption is only 1.7 W.  
Stainless steel flange.  
Waterproof body (IP68), nickel plated.  
Easy and flexible installation.  
Power supply:  
from 6 to 26 volts (AC)  
from 9 to 35 volts (DC).  
Dimensions: Dia 45 x 82 mm  
Weight: 0.2 kg



# ARCHITECTURE PROJECTORS

Enhance your buildings with all the power of the new CONTEST® IPANELs. Discover the benefit of mixing power with the opening angle.



**NEW**

R G B W

IP65 24x10W RGBW 31°

**IPANEL24x10QC**  
Projector with 24x10W QC IP65 LEDs

Code : H10794 899€ incl. VAT

**Contest®**

**NEW**

**FLY4IPANEL**  
Flight case for 4 IPANEL24x10QC

Code : H10866 559€ incl. VAT

**Contest®**

**NEW**

**IPANEL24x10QC-BARN**  
Leaves for IPANEL24x10QC

Code : H10889

**Contest®**

Optics: 24x10W RGBW 4-Zone LEDs  
 Opening angle: 31°  
 Integrated control unit with display with drop-down menu  
 DMX mode from 2 to 20 channels, master/slave, manual mode, presets and integrated show, choice of dimmer curves.  
 Waterproof wiring for power supply inputs/outputs and DMX inputs/outputs  
 Power supply: 100-240V/50-60Hz  
 Power consumption: 240 W  
 Waterproofing level: IP65  
 Natural convection cooling  
 Finish: cast aluminium painted black  
 Dimensions: 582 x 270 x 178 mm  
 Weight: 15 kg



R G B **IP65** **150W** **COB** **60°**

**LDP-COBWASH 150TC**  
150W IP65 COB RGB LED

Code : B05170      749€ incl. VAT



Optics: 1x150W RGB COB LED  
Opening angle: 60°  
Infrared remote control  
Integrated control unit with display with drop-down menu  
Waterproof wiring for power supply inputs/outputs and DMX inputs/outputs  
Power supply: 100-240V/50-60Hz  
Power consumption: 170W  
Waterproofing level: IP65  
Natural convection cooling  
Finish: cast aluminium, painted white  
Barndoor included  
Dimensions: 326 x 344 x 220 mm  
Weight: 9.5 kg

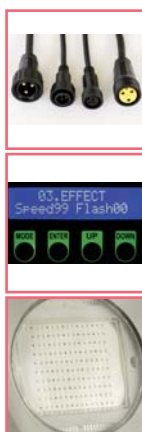

CW **IP65** **100W** **5600K** **60°**

**100CW LDP-COBWASH**  
100W white IP65 COB LED projector

Code : B05175      499€ incl. VAT



Optics: 1x100W 5600K COB LED  
Opening angle: 60°  
Infrared remote control  
Integrated control unit with display with drop-down menu  
Waterproof wiring for power supply inputs/outputs and DMX inputs/outputs  
Power supply: 100-240V/50-60Hz  
Power consumption: 120 W  
Waterproofing level: IP65  
Natural convection cooling  
Finish: cast aluminium, painted white  
Barndoor included  
Dimensions: 326 x 344 x 220 mm  
Weight: 8.2 kg



WW **IP65** **100W** **3200K** **60°**

**100WW LDP-COBWASH**  
100W IP65 COB LED projector

Code : B05176      529€ incl. VAT



Optics: 1x100W 3200K COB LED  
Opening angle: 60°  
Infrared remote control  
Integrated control unit with display with drop-down menu  
Waterproof wiring for power supply inputs/outputs and DMX inputs/outputs  
Power supply: 100-240V/50-60Hz  
Power consumption: 120 W  
Waterproofing level: IP65  
Natural convection cooling  
Finish: cast aluminium, painted white  
Barndoor included  
Dimensions: 326 x 344 x 220 mm  
Weight: 8.2 kg

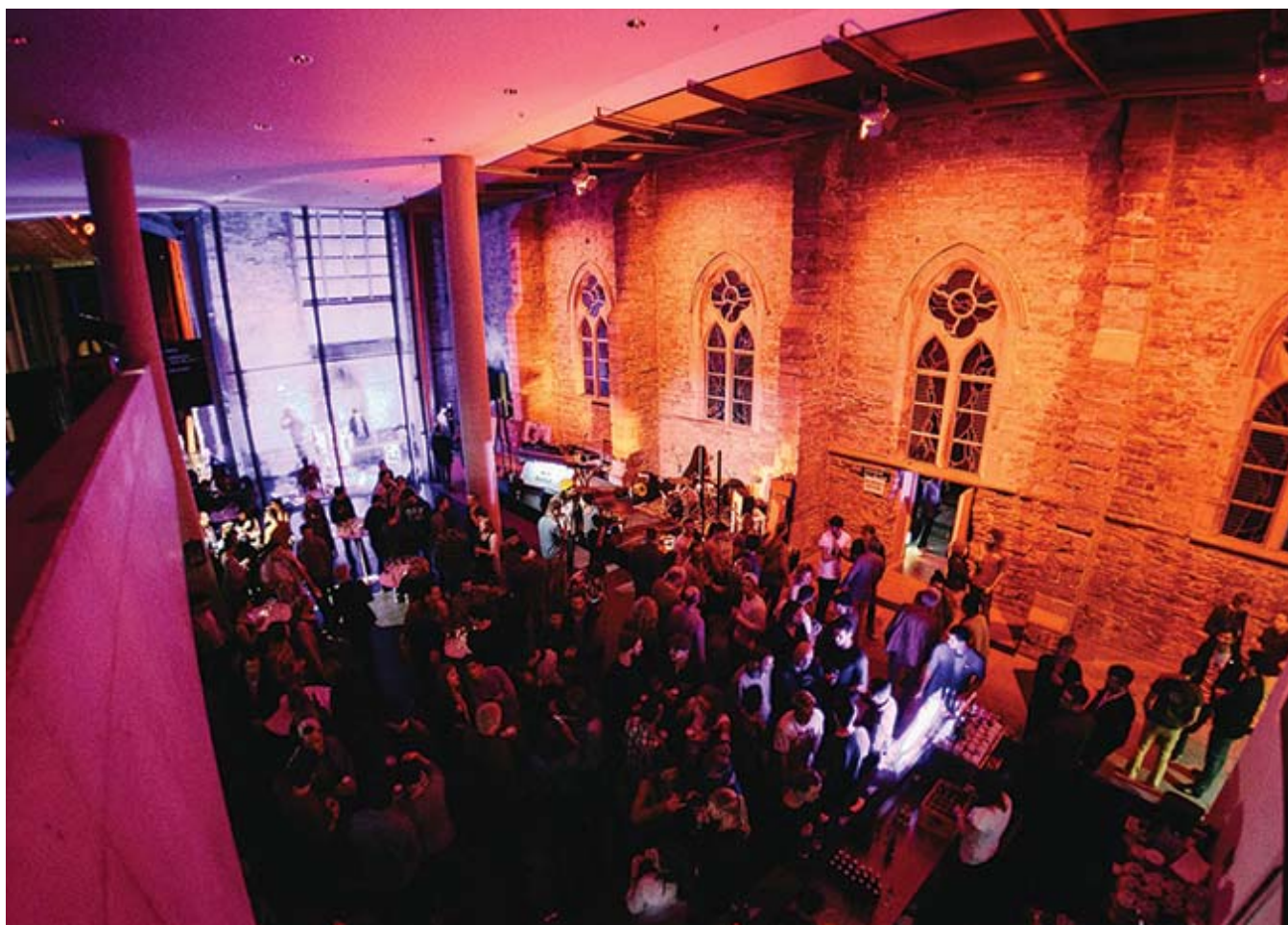

# ARCHITECTURE PROJECTORS



RGB IP65 60W 120°

**LDP-COBWASH 60TC**  
60W RGB IP65 COB LED projector

Code : B05171 359€ incl. VAT



Optics: 1x 60W RGB COB LED  
Opening angle: 120°  
Infrared remote control  
Integrated control unit with display with drop-down menu  
Waterproof wiring for power supply inputs/outputs and DMX inputs/outputs  
Power supply: 100-240V/50-60Hz  
Power consumption: 66W  
Waterproofing level: IP65  
Natural convection cooling  
Finish: cast aluminium, painted white  
Barndoor option available  
Dimensions: 223 x 202 x 122 mm  
Weight: 8.2 kg



CW IP65 50W 120°

**LDP-COBWASH 50CW**  
50W white IP65 COB LED Projector

Code : B05177 259€ incl. VAT



Optics: 1x 50W 5600K COB LED  
Opening angle: 120°  
Infrared remote control  
Integrated control unit with display with drop-down menu  
Waterproof wiring for power supply inputs/outputs and DMX inputs/outputs  
Power supply: 100-240V/50-60Hz  
Power consumption: 66W  
Waterproofing level: IP65  
Natural convection cooling  
Finish: cast aluminium, painted white  
Barndoor option available  
Dimensions: 223 x 202 x 122 mm  
Weight: 3.8 kg



WW IP65 50W 120°

**LDP-COBWASH 50WW**  
50W white COB IP65 LED projector

Code : B05178 259€ incl. VAT



Optics: 1x 50W 3200K COB LED  
Opening angle: 120°  
Infrared remote control  
Integrated control unit with display with drop-down menu  
Waterproof wiring for power supply inputs/outputs and DMX inputs/outputs  
Power supply: 100-240V/50-60Hz  
Power consumption: 66W  
Waterproofing level: IP65  
Natural convection cooling  
Finish: cast aluminium, painted white  
Barndoor option available  
Dimensions: 223 x 202 x 122 mm  
Weight: 3.8 kg



**LDP-COBWASH 50/60 BARNDOOR**

Code : B05191 19.90€ incl. VAT



Barndoor for:  
LDP-COBWASH 50WW  
LDP-COBWASH 50CW  
LDP-COBWASH 60TC.



WW IP65 80W 120°

**LDP-FLOOD80-WW**  
IP65 projector with white LED

Code : B05117 249€ incl. VAT



Optics: 1x80W 3000K COB LED  
Opening angle: 120°  
Power supply: 100-240V/50-60Hz  
Power consumption: 80W  
Waterproofing level: IP65  
Natural convection cooling  
Finish: cast aluminium, painted white  
Dimensions: 288 x 360 x 110 mm  
Weight: 6.5 kg



WW IP65 50W 120°

**LDP-FLOOD50-WW**  
IP65 projector with white LED

Code : B05116 159€ incl. VAT



Optics: 1x50W 3000K COB LED  
Opening angle: 120°  
Power supply: 100-240V/50-60Hz  
Power consumption: 50W  
Waterproofing level: IP65  
Natural convection cooling  
Finish: cast aluminium, painted white  
Dimensions: 290 x 236 x 150 mm  
Weight: 3.52 kg



WW IP65 30W 100°

**LDP-FLOOD30-WW**  
IP65 projector with white LED

Code : B05115 109€ incl. VAT



Optics: 1x30W 300K COB LED  
Opening angle: 100°  
Power supply: 100-240V/50-60Hz  
Power consumption: 30W  
Waterproofing level: IP65  
Natural convection cooling  
Finish: cast aluminium, painted white  
Dimensions: 250 x 185 x 126 mm  
Weight: 2.3 kg



NEW WW IP65 10W 120°

**LDP-FLOOD10-WW**  
IP65 projector with white LED

Code : B05114 39€ incl. VAT



Optics: 1x10W Bridgelux® LED  
Opening angle: 120°  
Power supply: 100-240V/50-60Hz  
Power consumption: 10W  
Waterproofing level: IP65  
Natural convection cooling  
Finish: cast aluminium, painted white  
Dimensions: 115 x 86 x 105 mm  
Weight: 0.63 kg



**IP20**
**96W**  
 RGBW

**LDP-COLORSTRIP 24FC**

Bar with 24x4W RGBW 25° 4-section LEDs - 100cm - IP20

Code : B05144      319€ incl. VAT



Optics: 24x4W RGBW 4-section LEDs  
 Opening angle: 15°  
 Integrated control unit with display with drop-down menu  
 Power supply input/output on IEC plug  
 DMX input/output on XLR 3-pin plug  
 Power supply: 100-240V/50-60Hz  
 Power consumption: 85 W  
 Waterproofing level: IP20  
 Natural convection cooling  
 Dimensions: 961 x 56 x 101/122 mm  
 Weight: 3.6 kg



**IP20**
**48W**  
 RGBW

**LDP-COLORSTRIP 12FC**

Bar with 12x4W RGBW 15° 2-section LEDs - 50cm - IP20

Code : B05143      259€ incl. VAT



Optics: 12x4W RGBW 2-section LEDs  
 Opening angle: 15°  
 Integrated control unit with display with drop-down menu  
 Power supply input/output on IEC plug  
 DMX input/output on XLR 3-pin plug  
 Power supply: 100-240V/50-60Hz  
 Power consumption: 56 W  
 Waterproofing level: IP20  
 Natural convection cooling  
 Dimensions: 479 x 56 x 101/122 mm  
 Weight: 2.2 kg

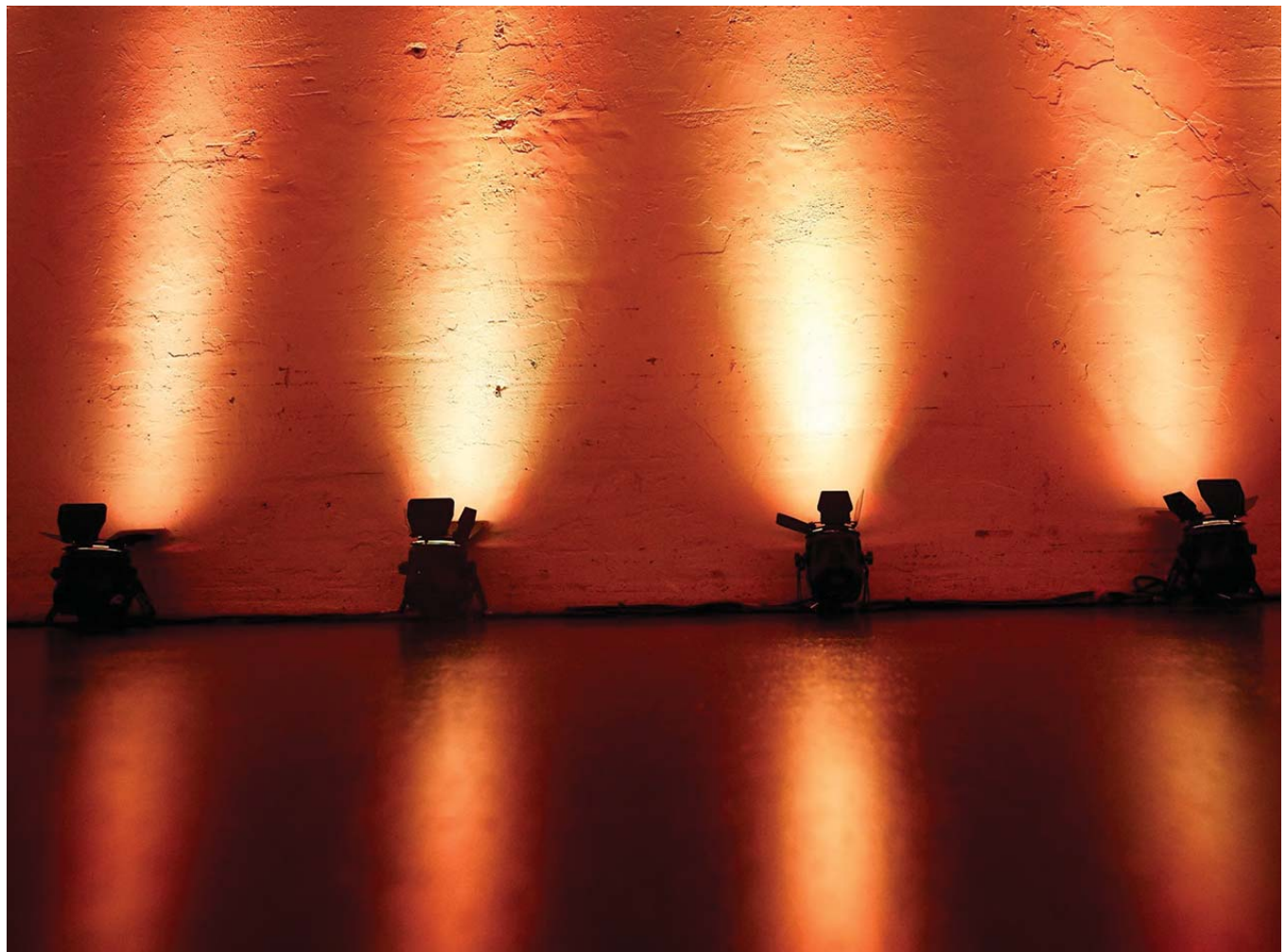

# ARCHITECTURE PROJECTORS



**NEW**



**IP65**

**48W**  
 RGBW

**15°**

**LDP-POWERBAR 12FC**  
 LED projectors 12x4W RGBW IP65 LEDs.  
 Bar length 48 cm

Code : B05134      319€ incl. VAT



**NEW**





**IP65**

**96W**  
 RGBW

**15°**

**LDP-POWERBAR 24FC**  
 IP65 LED projector. 24x4W RGBW LEDs. Bar length 96 cm

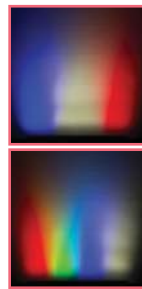
Code : B05132      479€ incl. VAT

**LDP-JUNCTION IP68**  
 Waterproof connection box for the LDP series and other outdoor DMX projectors.

Code : B05112      59€ incl. VAT



Optics: 12x4W RGBW LEDs  
 Opening angle: 15°  
 Integrated control unit with OLED display and backlit touch buttons  
 Waterproof wiring for power supply inputs/outputs and DMX inputs/outputs  
 Power supply: 100-240V/50-60Hz  
 Power consumption: 56W  
 Waterproofing level: IP65  
 Natural convection cooling  
 Depressurisation valve with waterproof membrane  
 Finish: cast aluminium painted white  
 Dimensions: 480 x 56 x 13.5 mm  
 Weight: 3 kg

Optics: 24x4W RGBW LEDs  
 Opening angle: 15°  
 Integrated control unit with OLED display and backlit touch buttons  
 Waterproof wiring for power supply inputs/outputs and DMX inputs/outputs  
 Power supply: 100-240V/50-60Hz  
 Power consumption: 85W  
 Waterproofing level: IP65  
 Natural convection cooling  
 Depressurisation valve with waterproof membrane  
 Finish: cast aluminium painted white  
 Dimensions: 960 x 56 x 13.5 mm  
 Weight: 5.02 kg

Waterproof connection box for the LDP series and other outdoor DMX projectors. IP68 protection: Outdoor or even underground use.  
 Power supply compartment with 3 input outlets  
 DMX compartment with 4 input outlets  
 Very easy and fast internal connection  
 Ideal for the LDP series and any other combination of outdoor power/signal (PowerBeam lighting, LED Blaster, Powerbank, ...)



Light Integration Accessories				
<b>A</b>	B04911	POWERLINK CABLE 1.5 m - Powerlink Cable 1.5M for Outdoor range	HILEC®	17,90€
<b>B</b>	B04913	POWERLINK CABLE 10m - Powerlink Cable 10m, for Outdoor range	HILEC®	54,90€
<b>C</b>	B04324	POWERLINK CABLE 5m - Powerlink Cable 5m, for Outdoor range	HILEC®	35,00€
<b>D</b>	B04908	SIGNAL LINK CABLE 1.5M - Signal Link Cable 1.5m for Outdoor range	HILEC®	6,90€
<b>E</b>	B04904	SIGNAL LINK CABLE 1.5M - Signal Link Cable 1.5m for Outdoor range	HILEC®	24,90€
<b>F</b>	B04903	SIGNAL LINK CABLE 5M - Signal Link Cable 5m, for Outdoor range	HILEC®	14,50€
<b>G</b>	B05157	LDP-Powercable 2M - Power cable L=2m for LDP-POWERBAR, COBWA	HILEC®	9,90€
<b>H</b>	B05158	LDP-Powercable 5M - Power cable L=5m for LDP-POWERBAR, COBWA	HILEC®	16,90€



# AMBIENT PROJECTORS



IP20 12x3W RGB 25°

## TRI4U

Light bar with 4x3W LED tricolour projectors

Code : H9955 269€ incl. VAT



IP20 12x1W RGB 30°

## MINIBAR

Mini bar with 12x1W RGB LEDs

Code : H10022 89€ incl. VAT

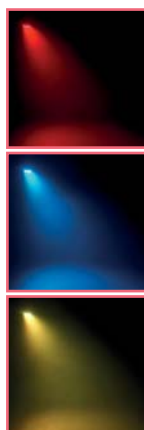

IP20 6x3W RGB 30°

## MINITRUSS-6TCb

Structure decoration projector with 6x3W TRI LEDs

Code : H10365 129€ incl. VAT



12x3W RGB LEDs located on 4 projectors  
Opening angle: 25° per projector  
Independent orientation per projector  
Modes of operation:  
- DMX  
- Standalone  
- Musical  
- Master / slave  
Specially designed hanging bracket with integrated hook for stand  
Dimensions: 375 x 160 x 60 mm  
Net weight: 2.5 Kg

Light source: 12x1W LEDs  
LED: 4x Red + 4x Green + 4x Blue  
Opening angle: 30°  
Modes of operation:  
- DMX  
- Standalone  
- Musical  
- Master / slave  
Power supply: 230V - 50Hz  
Power consumption: 20W  
Dimensions: 295 x 78 x 110 mm  
Net weight: 1.5 kg

Light source: 6x3W RGB LEDs  
Opening angle: 30°  
Modes of operation:  
- DMX  
- Standalone  
- Musical  
- Master / slave  
Input/output on IEC plug  
Power supply: 230V - 50Hz  
Power consumption: 30W  
Dimensions: 135 x 135 x 132 mm  
Net weight: 1.4 kg

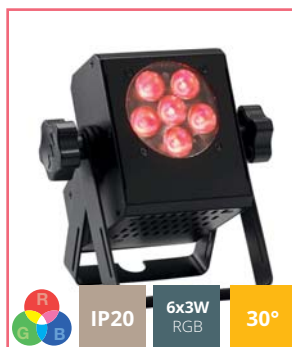

IP20 6x3W RGB 30°

## MINICUBE-6TCb

Compact projectors with 6x3W satin TRINoIR LEDs

Code : H10147 99€ incl. VAT



IP20 60W 18°

## LED ROTOGOBO

60W gobos LED projector

Code : B04528 289€ incl. VAT



IP20 10W

## Artist10W

10W gobo LED projector

Code : H10651 59€ incl. VAT



Light source: 6x3W RGB LEDs  
Opening angle: 30°  
Modes of operation:  
- DMX  
- Standalone  
- Musical  
- Master / slave  
DMX input and output  
Power supply: AC 100/240V - 50/60Hz  
Power consumption: 30 W  
Dimensions: 166 x 180 x 110 mm  
Net weight: 1.35 kg

A powerful 60W white LED motif projector  
Low gobo temperature: no need for expensive thermo-resistant glass or metal gobos!  
Usable with plastic gobos created by a simple laser printer!  
Metal and glass gobos are of course always usable.  
Easy adjustment by rotary knobs on the back of the projector:  
Rotation speed control of the gobo  
Dimmer switch to adjust light intensity  
Beam angle: 18°  
Dimensions: 236 x 234 x 206 mm  
Weight: 3.4 kg

1x10W white LED  
Adjustment of rotation speed  
Power, stop and auto off timer button  
Power consumption: 12W maximum  
Power supply: AC 100/240V - 50/60Hz with 12V DC adapter provided  
Water resistant plastic case  
Suspension moving head, table support cup and floor mounting pin  
Dimensions: 170 x 140 x 240 mm  
Weight: 0.700 kg

# BATTERY PROJECTORS



**IP65** **5x12W** RGBWAUV **25°**

**IPair5x12Six**  
IP65 AirDMX battery projector

Code : H10411 429€ incl. VAT



Optics: 5x12W RGBWAUV LEDs  
Opening angle: 25°  
AirDMX integrated transmitter / receiver  
Compatible with AirBox-ER1  
Integrated control unit with display with drop-down menu  
Infrared remote control  
DMX IN and OUT with 3-pin IP plugs  
POWER IN/OUT with 4-pin IP plugs  
Power supply: 100-240V/50-60Hz



**FLY-IPairx6**  
Flight case for 6 IPair5x12Six

Code : H10464 399€ incl. VAT



Power consumption: 65 W  
12-cell 22.2V 4.4Ah lithium battery  
Battery life: 6 hours in color changing mode - 4 hours in white [RGB]  
Waterproofing level: IP65  
Finish: cast aluminium painted black  
Dimensions: 240 x 165 x 280 mm  
Weight: 3.5 kg



<b>A</b>	H10465	FICIP-DMXm - DMX male waterproof plug for IPAir- IP68	12,00€ incl. VAT
<b>B</b>	H10466	FICIP-DMXF - DMX female waterproof plug for IPAir- IP68	13,00€ incl. VAT
<b>C</b>	H10467	FICIP-POWm - Male waterproof power plug for IPAir- IP68	10,00€ incl. VAT
<b>D</b>	H10468	FICIP-POWf - Female waterproof power plug for IPAir- IP68	13,00€ incl. VAT



**NEW**



**IP65** **6x10W** RGBWA **25°**

**BT-AKKULITE IP**  
Outdoor 6x10W RGBWA 5in1 LED projector + infrared remote control

Code : B05135 439€ incl. VAT



Optics: 6x10W RGBWA LEDs  
Opening angle: 22°  
Wireless transmitter / receiver compatible with protocol W-DMX G4  
Integrated control unit with display with drop-down menu  
Infrared remote control  
DMX IN / OUT with 3-pin XLR, POWER IN by Pro Con (Seetronic)  
Waterproofing level: IP65  
Power supply: 100-240V/50-60Hz Battery  
Power consumption: 60 W  
Dimensions: 180 x 150 x 198 mm  
Weight: 4.5 kg



**IP20** **6x10W** RGBWA **22°**

**ACCU COLOR-WHITE**  
Battery powered LED projector, built around 6 RGBWA [10W] LEDs

Code : B05126 339€ incl. VAT



Optics: 6x10W RGBWA LEDs  
Opening angle: 22°  
Wireless transmitter / receiver compatible with protocol W-DMX G4  
Integrated control unit with display with drop-down menu  
Infrared remote control  
DMX IN and OUT with 3-pin XLR, POWER IN/OUT with Powercon  
Power supply: 100-240V/50-60Hz Battery  
Power consumption: 60 W  
Finish: white delivered with a transparent plastic cover  
Dimensions: 167 x 138 x 185 mm  
Weight: 4.14 kg



**IP20** **6x10W** RGBWA **22°**

**ACCU COLOR-BLACK**  
Battery powered LED projector, built around 6 RGBWA [10W] LEDs

Code : B05128 339€ incl. VAT



Optics: 6x10W RGBWA LEDs  
Opening angle: 22°  
Wireless transmitter / receiver compatible with protocol W-DMX G4  
Integrated control unit with display with drop-down menu  
Infrared remote control  
DMX IN and OUT with 3-pin XLR, POWER IN/OUT with Powercon  
Power supply: 100-240V/50-60Hz Battery  
Power consumption: 60 W  
Finish: black delivered with a transparent plastic cover  
Dimensions: 167 x 138 x 185 mm  
Weight: 4.14 kg





**CASE-2 for 6x ACCU COLOR**

6x ACCU COLOR projectors + accessories

Code : B03268 199€ incl. VAT

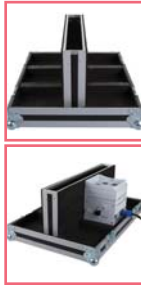

**IP20 15W RGBW 30°**

**ACCU DECOLITE**

A battery powered LED projector, built around RGB + White 15W LED, with embedded wireless DMX

Code : B05127 199€ incl. VAT



**NEW IP65 15W RGBW 10°**

**ACCU DECOLITE IP**

A battery powered IP65 LED projector, built around 15W RGB + White LED, with embedded wireless DMX

Code : B05136 249€ incl. VAT



Flight case for 6x ACCU COLOR or 6x BT-AKKULITE projectors and accessories

Optics: 1x15W RGBW LED  
Opening angle: 10 to 25°  
Wireless transmitter / receiver compatible with protocol W-DMX G4  
Integrated control unit with display with drop-down menu  
Infrared remote control  
Power supply: 100-240V/50-60Hz Battery  
Power consumption: 15 W  
Dimensions: 168 x 138 x 62 mm  
Weight: 1.61 kg

Optics: 1x15W RGBW LED  
Opening angle: 10°  
Wireless transmitter / receiver compatible with protocol W-DMX G4  
Integrated control unit with display with drop-down menu  
Infrared remote control  
Power supply: 100-240V/50-60Hz  
Power consumption: 15 W  
Dimensions: 172 x 138 x 185 mm  
Weight: 1.61 kg



**NEW ACCU DECOLITE IP TUBE 50CM**

50cm acrylic tube for Accu Decolite IP

Code : B05137 27.90€ incl. VAT



**NEW 100CM ACCU DECOLITE IP TUBE**

100cm acrylic tube for Accu Decolite IP

Code : B05138 31.90€ incl. VAT

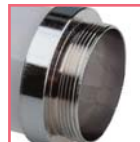

**NEW 150CM ACCU DECOLITE IP TUBE**

150cm acrylic tube for Accu Decolite IP

Code : B05139 39€ incl. VAT

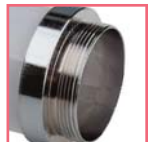

# SCENOGRAPHY PROJECTORS

---

"The scenographer is the one who composes with volumes, objects, colours, lights and textures".

This term "scenographer" consists of three major categories:

- The scenographer of a show who puts on a show or a particular event.
- The scenographer of equipment who designs a place intended to host live shows or various events.
- The scenographer of exhibitions who intervenes in the field of museums and exhibitions.



## EQUIPMENT FOR PERMANENT OR TEMPORARY EXHIBITION

A high performance, a very long life and low power consumption allow the LED source to integrate compact, aesthetic and efficient projectors.

They will enhance all kinds of places and surfaces while respecting the subjects lit.

## STAGE EQUIPMENT FOR LIVE PERFORMANCE

Economical in energy and easy to install, the products of the ScenoGraFX range are ideal lighting solutions for the optimisation of all your events

The projectors in the range offer lighting quality and dimming that are identical to filament lamps thanks to the different built-in dimmer modes.

## LED LIGHT SOURCES

The LED light sources provide new solutions in many areas. Currently, LEDs are used for theatrical, architectural and event lighting.

Building on the success of their range of animation projectors, Contest® and Briteq® develop this technology with the creation of a new range of projectors designed to produce exceptional brightness with great optical and ergonomic quality.



**CW** **370W** **20°**  
6500K

**EXPO CANNON**  
370 W cool white CREE LED projector

Code : B05133 1359€ incl. VAT



Optics: 37x10W 6500K CREE LED  
Opening angle: 20°  
Brightness of 26953 Lux at 4m  
Integrated control unit with OLED LCD Display with drop-down menu  
DMX IN / OUT with XLR 3-pin plugs, POWER IN/OUT with NEUTRIK powerCON®  
Power supply: 100-240V/50-60Hz  
Power consumption: 380 W heat sink and silent fan.  
Finish: Black extruded aluminium  
Frost filter and barndoor included  
Dimensions: 295 x 315 x 377 mm  
Weight: 6.2 kg

**WW** **150W** **90°**  
3200K x113°

**SFX-H0150W**  
150W warm white asymmetrical floodlight type COB LED projector

Code : H10702 799€ incl. VAT



Optics: 1x150W 3200K COB LED  
Opening angle: 90°x113°  
Brightness of 530 Lux at 4m  
Integrated control unit with LCD display with drop-down menu  
DMX IN / OUT with XLR 3-pin plugs, POWER IN/OUT with powerCON plugs  
Power supply: 100-240V/50-60Hz  
Power consumption: 155 W heat sink and silent fan.  
Finish: Black  
Delivered with barndoor, filter frame  
Dimensions: 295 x 315 x 377 mm  
Weight: 6.2 kg

**R** **G** **B** **W** **150W** **90°**  
RGBW x113°

**SFX-H0150QC**  
150W RGBW asymmetrical floodlight type COB LED projector

Code : H10701 899€ incl. VAT



Optics: 1x150W RGBW COB LED  
Opening angle: 90°x113°  
Brightness of 289 Lux at 4m  
Integrated control unit with LCD display with drop-down menu  
DMX IN / OUT with XLR 3-pin plugs, POWER IN/OUT with powerCON plugs  
Power supply: 100-240V/50-60Hz  
Power consumption: 155 W heat sink and silent fan.  
Finish: Black  
Delivered with barndoor, filter frame  
Dimensions: 295 x 315 x 377 mm  
Weight: 6.2 kg



**WW** **100W** **10°**  
3200K 50°

**BT-THEATRE 100EC Mk2**  
LED with 10° to 50° manual zoom

Code : B06008 419€ incl. VAT



Optics: 1x100W 3200K COB LED  
manual zoom: 10° to 50°  
7800 lux @ 2m (beam angle: 10°)  
Integrated control unit with LCD display with drop-down menu  
DMX IN/OUT with 3/5-pin XLR plugs  
POWER IN/OUT with powerCON plugs  
Power supply: 100-240V/50-60Hz  
Power consumption: 125 W  
Silent fan (31dB@1m)  
Finish: Black  
Delivered with barndoor, filter frame  
Dimensions: 2788 x 305 x 336 mm  
Weight: 6.2 kg



**WW** **100W** **10°**  
3200K 50°

**BT-THEATRE 100EC WHITE**  
LED with 10° to 50° manual zoom

Code : B06012 419€ incl. VAT



Optics: 1x100W 3200K COB LED  
manual zoom: 10° to 50°  
7800 lux @ 2m (beam angle: 10°)  
Integrated control unit with LCD display with drop-down menu  
DMX IN/OUT with 3/5-pin XLR plugs  
POWER IN/OUT with powerCON plugs  
Power supply: 100-240V/50-60Hz  
Power consumption: 125 W  
Silent fan (31dB@1m)  
Finish: white  
Delivered with barndoor, filter frame  
Dimensions: 2788 x 305 x 336 mm  
Weight: 6.2 kg



**WW** **250W** **15°**  
3200K 50°

**BT-THEATRE 250EZ**  
Powerful LED theatre projector with 10° - 50° electronic zoom

Code : B06016 839€ incl. VAT



Optics: 1x250W 3200K COB LED  
Opening zoom angle: 15° to 50°  
Brightness of 1500 to 7735 Lux at 4m  
Direct access to the dimmer and zoom  
Integrated control unit with LCD display with drop-down menu  
DMX IN/OUT with 3/5-pin XLR plugs  
POWER IN/OUT with powerCON plugs  
Power supply: 100-240V/50-60Hz  
Power consumption: 275 W heat sink and silent fan.  
Finish: Black  
Delivered with barndoor, filter frame  
Dimensions: 458 x 336 x 399 mm  
Weight: 8.9 kg



# SCENOGRAPHY PROJECTORS



**SFX-FR250W**  
Fresnel warm white 250W COB LED projector with motorized zoom

Code : H10707 839€ incl. VAT



Optics: 1x 250W 3200K COB LED  
Opening zoom angle: 15° to 45°  
Brightness of 2280 to 7900 Lux at 4m  
Direct access to the dimmer and zoom  
Integrated control unit with LCD display with drop-down menu  
DMX IN/OUT with 3/5-pin XLR plugs  
POWER IN/OUT with powerCON plugs  
Power supply: 100-240V/50-60Hz  
Power consumption: 275 W heat sink and silent fan.  
Finish: Black  
Delivered with barndoor filter frame  
Dimensions: 458 x 336 x 399 mm  
Weight: 8.9 kg



**SFX-FR150W**  
Fresnel warm white 150W COB LED projector with motorized zoom

Code : H10708 599€ incl. VAT



Optics: 1x 150W 3200K COB LED  
Opening zoom angle: 15° to 45°  
Brightness of 1242 to 6540 Lux at 4m  
Direct access to the dimmer and zoom  
Integrated control unit with LCD display with drop-down menu  
DMX IN/OUT with 3/5-pin XLR plugs  
POWER IN/OUT with powerCON plugs  
Power supply: 100-240V/50-60Hz  
Power consumption: 175 W heat sink and silent fan.  
Finish: Black  
Delivered with barndoor filter frame  
Dimensions: 458 x 336 x 399 mm  
Weight: 8.9 kg



**SFX-PC60QCb**  
60W RGBW COB 4-in-1 LED with manual zoom and black finish

Code : H10705 329€ incl. VAT



Optics: 1x 60W RGBW COB LED  
manual zoom: 20° to 45°  
Brightness of 250 to 1870 Lux at 3m  
Integrated control unit with LCD display with drop-down menu  
DMX IN/OUT with 3-pin XLR plugs  
POWER IN with powerCON plugs  
Power supply: 100-240V/50-60Hz  
Power consumption: 70 W  
Dissipation fan  
Finish: Black  
Delivered with barndoor filter frame  
Dimensions: 241 x 196 x 173 mm  
Weight: 3.6 kg

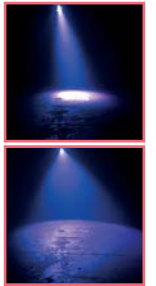

**SFX-GOR050W**  
50W LED projector with zoom and rotating gobo

Code : H10848 299€ incl. VAT



50W COB LED gobo projector  
Brightness of 2840 Lux at 3m at 15°  
Opening of 15° to 30°  
Manual focus of the lens and opening  
Infrared remote control  
Rotary gobo holder (outer diam. 25.8 mm, image 19 mm)  
4 gobos included  
DMX IN/OUT with 3-pin XLR plugs  
POWER IN/OUT with Powercon  
Silent ventilation  
USB port for WTR-DMX (option)  
Power supply: 100-240V/50-60Hz  
Dimensions: 315 x 175 x 266 mm  
Power consumption: 53 W  
Finish: black  
Weight: 2.8 kg

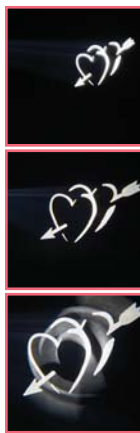

**SFX-B15QC**  
15W 4° QC LED beam projector with remote control

Code : H10831 139€ incl. VAT



Optics: 1x15W RBGW COB LED  
Opening angle: 4° (10, 30 and 50° frost)  
Brightness of 5070 Lux at 3m  
Infrared remote control  
Ready for a DMX wireless connection with the WTR-DMX option  
1-8 channel DMX, fixed colours, Step or Fade programs, Auto mode with sound sensitivity, Slave Mode  
LCD display with drop-down menu  
DMX IN/OUT with 3-pin XLR plugs  
POWER IN/OUT with Powercon  
Power supply: 100-240V/50-60Hz  
Power consumption: 62 W  
Forced fan  
Finish: black  
Dimensions: 220 x 147 x 191 mm  
Weight: 1.8 kg

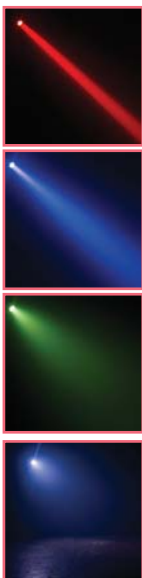

OPTIONAL:

**WTR-DMX DONGLE**  
(code B04645)

The perfect solution for all those who seek wireless DMX

Compatible with:

**SFX-GOR050W, SFX-B15QC**  
and **SFX-DE50W**



**60W** **20°**  
RGBW **45°**

**SFX-PC60QCw**  
60W COB 4-in-1 RGBW LED plano-convex projector with manual zoom White finish

Code : H10706 329€ incl. VAT



Optics: 1x 60W RGBW COB LED  
manual zoom: 20° to 45°  
Brightness of 250 to 1870 Lux at 3m  
Integrated control unit with LCD display with drop-down menu  
DMX IN/OUT with 3-pin XLR plugs  
POWER IN with powerCON plugs  
Power supply: 100-240V/50-60Hz  
Power consumption: 70 W  
Dissipation fan  
Finish: white  
Delivered with barndoor filter frame  
Dimensions: 241 x 196 x 173 mm  
Weight: 3.6 kg



**50W** **20°**  
3200K **45°**

**SFX-PC50Wb**  
50W COB warm white LED plano-convex projector with manual zoom Black finish

Code : H10703 269€ incl. VAT



Optics: 1x50W 3200K COB LED  
manual zoom: 20° to 45°  
Brightness of 440 to 2200 Lux at 3m  
Integrated control unit with LCD display with drop-down menu  
DMX IN/OUT with 3-pin XLR plugs  
POWER IN with powerCON plugs  
Power supply: 100-240V/50-60Hz  
Power consumption: 55 W  
Dissipation fan  
Finish: black  
Delivered with barndoor filter frame  
Dimensions: 241 x 196 x 173 mm  
Weight: 3.6 kg



**50W** **20°**  
3200K **45°**

**SFX-PC50Ww**  
50W COB warm white LED plano-convex projector with manual zoom Black finish

Code : H10704 269€ incl. VAT



Optics: 1x50W 3200K COB LED  
manual zoom: 20° to 45°  
Brightness of 440 to 2200 Lux at 3m  
Integrated control unit with LCD display with drop-down menu  
DMX IN/OUT with 3-pin XLR plugs  
POWER IN with powerCON plugs  
Power supply: 100-240V/50-60Hz  
Power consumption: 55 W  
Dissipation fan  
Finish: white  
Delivered with barndoor filter frame  
Dimensions: 241 x 196 x 173 mm  
Weight: 3.6 kg



**60W** **10°**  
RGBW **50°**

**BT-THEATRE 60FC**  
60W RGBW COB LED with 10° - 50° manual zoom.

Code : B06015 319€ incl. VAT



Optics: 1x 60W RGBW COB LED  
manual zoom: 10° to 50°  
330 lux at 5m and 10°, 77 lux at 5m and 40°  
Integrated control unit with LCD display with drop-down menu  
DMX IN/OUT with 3-pin XLR plugs  
POWER IN with 1 m cord with plug  
Power supply: 100-240V/50-60Hz  
Power consumption: 62 W  
Dissipation fan  
Finish: black  
Delivered with barndoor filter frame  
Dimensions: 241 x 196 x 173 mm  
Weight: 3.6 kg



**50W** **10°**  
3200K **50°**

**BT-THEATRE 50WW**  
LED with 10° - 50° manual zoom. 50W warm white LED

Code : B06013 259€ incl. VAT



Optics: 1x50W 3200K COB LED  
manual zoom: 10° to 50°  
330 lux at 5m and 10°, 77 lux at 5m and 40°  
Integrated control unit with LCD display with drop-down menu  
DMX IN/OUT with 3-pin XLR plugs  
POWER IN with 1 m cord with plug  
Power supply: 100-240V/50-60Hz  
Power consumption: 55 W  
Dissipation fan  
Finish: black  
Delivered with barndoor filter frame  
Dimensions: 241 x 196 x 173 mm  
Weight: 3.6 kg



**50W** **10°**  
3200K **50°**

**BT-THEATRE 50WW**  
10° - 50° manual zoom LED. 50W warm white LED

Code : B06014 259€ incl. VAT



Optics: 1x50W 3200K COB LED  
manual zoom: 10° to 50°  
330 lux at 5m and 10°, 77 lux at 5m and 40°  
Integrated control unit with LCD display with drop-down menu  
DMX IN/OUT with 3-pin XLR plugs  
POWER IN with 1 m cord with plug  
Power supply: 100-240V/50-60Hz  
Power consumption: 55 W  
Dissipation fan  
Finish: white  
Delivered with barndoor filter frame  
Dimensions: 241 x 196 x 173 mm  
Weight: 3.6 kg



# SCENOGRAPHY PROJECTORS



WW 160W  
3200K

## BT-PROFILE160/ LED ENGINE

160W COB LED cutout

Code : B06000 639€ incl. VAT



High power COB LED profile spot  
Optics: 1x160W 3200K COB LED  
11566 Lumen  
Compatible with ETC "Source Four" optics  
Integrated control unit with LCD display  
DMX IN/OUT with 3-pin XLR plugs  
POWER IN with power cord without plug  
Power supply: 100-240V/50-60Hz  
Power consumption: 170 W  
Extremely silent cooling system using  
heat pipe technology  
Finish: black  
Weight: 6.1 kg  
Option:  
BT-PROFILE160/OPTIC 15-30  
BT-PROFILE160/OPTIC 25-50



15°  
30°

## BT-PROFILE160/OP- TIC 15-30

Code : B06001 249€ incl. VAT



Optical elements with special coating for  
clear and well-defined projections  
Four contoured, specially coated blades  
for minimal reflections  
BT-PROFILE160/OPTIC 15-30  
15°-30° zoom range  
Lockable compartment for the use of  
available options:  
BT-PROFILE160/GOBO HOLDERIRIS  
BT-PROFILE160/IRIS  
Using zoom/focus combined with lock-  
ing mechanism  
BT-PROFILE160/LED ENGINE This is the  
active part. Equipped with a 160W COB  
LED, it is sold separately.



25°  
50°

## BT-PROFILE160/OP- TIC 25-50

Code : B06002 249€ incl. VAT



Optical elements with special coating for  
clear and well-defined projections  
Four contoured, specially coated blades  
for minimal reflections  
BT-PROFILE160/OPTIC 25-50  
25°-50° zoom range  
Lockable compartment for the use of  
available options:  
BT-PROFILE160/GOBO HOLDERIRIS  
BT-PROFILE160/IRIS  
Using zoom/focus combined with lock-  
ing mechanism  
BT-PROFILE160/LED ENGINE This is the  
active part. Equipped with a 160W COB  
LED, it is sold separately.



## BT-PROFILE160/ GOBO HOLDER

GOBO door for BT-PROFILE160/OPTIC

Code : B06003 16.90€ incl. VAT



GOBO holder for BT-PROFILE160/OPTIC  
Outer diameter of the gobos: 86mm,  
Optical diameter: 64.5mm



## BT-PROFILE160/IRIS

iris for BT-PROFILE160/OPTIC

Code : B06004 95€ incl. VAT



Iris for BT-PROFILE160/OPTIC  
Opening diameter: adjustable from 5 to  
74 mm

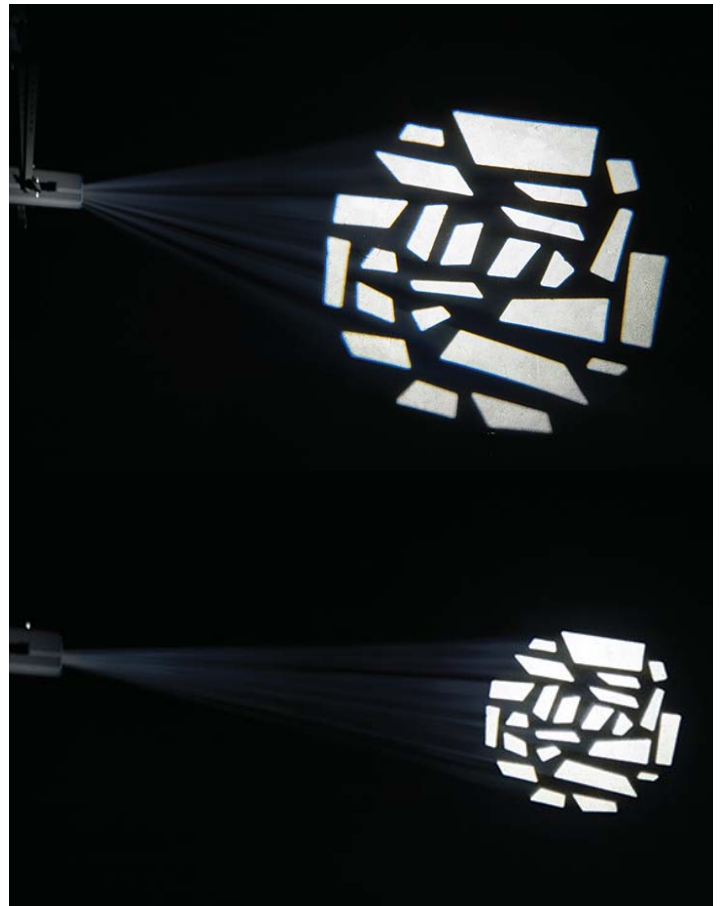





**WW 10W**  
3200K

**BT-MINIPROFILE**  
**3200K LED**  
Mini LED-profiled projector

Code : B06009 279€ incl. VAT



Mini 10W 3200K LED-profile projector  
Variation in intensity: using 230V power block or 0-10V voltage.  
Power supply: 100-240V/50-60Hz  
Dissipation fan  
Finish: black  
Dimensions: 290 x 107 x 236 mm  
Weight: 1.25 kg



**19°**

**BT-MINIPROFILE**  
**OPTIC 19deg**  
Optional lens 19°

Code : B06010 29€ incl. VAT





**26°**

**BT-MINIPROFILE**  
**OPTIC 26deg**  
Optional lens 26°

Code : B06011 29€ incl. VAT





**15°**  
**30°**

**BT-MINIPROFILE**  
**OPTIC ZOOM**  
19°-36° zoom

Code : B06017 99€ incl. VAT



19°-36° optional zoom for BT-MINI-PROFILE.



**40W**  
3200K

**SFX-DE40W**  
40W white LED profile projector with gobo holder

Code : H10700 329€ incl. VAT



40W 3200K COB LED profile spot  
Brightness of 1150 Lux at 3m  
Opening of 19°  
Beam modulation blades  
Electronic dimmer  
Manual lens focusing  
Gobo holder (outer diameter 34mm, image 24mm) 2 gobos included  
POWER IN with power cord with plug  
Convection fan  
Power supply: 100-240V/50-60Hz  
Dimensions: 273 x 111 x 100 mm  
Power consumption: 40 W  
Finish: black  
Weight: 1.2 kg



**NEW**

**NW 50W**  
4000K

**15°**  
**30°**

**SFX-DE50W**  
50W DMX LED profile with gobo holder and 10-30° zoom

Code : H10836 279€ incl. VAT



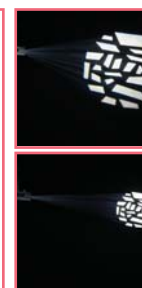

50W COB LED profile spot  
Brightness of 2840 Lux at 3m at 15°  
Opening of 15° to 30°  
Beam modulation blades  
Manual focus of the lens and opening  
Infrared remote control  
Gobo holder (outer diam. 25.8mm, image 19mm), 4 gobos included  
DMX IN / OUT with 3-pin plugs  
POWER IN / OUT with Powercon  
Silent ventilation  
USB port for WTR-DMX (option)  
Power supply: 100-240V/50-60Hz  
Dimensions: 500 x 150 x 100 mm  
Power consumption: 53 W  
Finish: black  
Weight: 3 kg



# FLAT PROJECTORS











**irLDFLAT**  
**12x12SIXb**  
 12x12W six-colour LEDs

Code : H10143      269€ incl. VAT



12x12W six-colour RGBWA + UV LEDs  
 Beam opening: 40°  
 Light intensity: 1400 Lux at 3 m  
 Infrared remote control  
 Digital display with drop-down menu  
 Input and output on IEC plugs  
 Modes of operation:  
 2-9 channel DMX, fixed colours, Step or Fade programs, Auto mode with sound sensitivity, Slave Mode, Editing and playback of a 20-step program  
 Power consumption: 160 W  
 Power supply: AC 100/240V - 50/60Hz  
 DMX input and output  
 Dimensions: 275 x 310 x 110 mm  
 Net weight: 3.4 kg











**irLEDFLAT**  
**12x12fXb-Air**  
 12 six-colour LEDs with wireless DMX

Code : H10526      299€ incl. VAT



12x12W six-colour RGBWA + UV LEDs  
 Beam opening: 40°  
 Light intensity: 1400 Lux at 3 m  
 Wireless airDMX embedded transmitter and receiver. 2.4-GHz frequency band  
 Compatible with AirBox-ER1  
 Infrared remote control  
 Digital display with drop-down menu  
 Input and output on IEC plugs  
 Modes of operation:  
 2-9 channel DMX, fixed colours, Step or Fade programs, Auto mode with sound sensitivity, Slave Mode, EEditing and playback of a 20-step program  
 Power consumption: 160 W  
 Power supply: AC 100/240V - 50/60Hz  
 DMX input and output  
 Dimensions: 275 x 310 x 110 mm  
 Net weight: 3.4 kg











**PLANO LED 6in1**  
 7x12W RGBWA + UV! LEDs

Code : B04961      179€ incl. VAT



7x12W six-colour RGBWA + UV LEDs  
 Beam opening: 30°  
 Infrared remote control  
 Ready for a DMX wireless connection with the WTR-DMX option  
 Digital display with drop-down menu  
 Input and output on IEC plugs  
 Modes of operation:  
 Standalone, Master/slave mode, DMX mode, usable with LEDCON-XL controller  
 DMX input and output  
 Power consumption: 50 W  
 Power supply: AC 100/240V - 50/60Hz  
 Dimensions: 210 x 130 x 230 mm  
 Net weight: 2.83 kg









**irLEDFLAT-5x12SIXb**  
 Compact projector with six-colour LEDs, 5x12W LEDs

Code : H10142      169€ incl. VAT



5x12W six-colour RGBWA + UV LEDs  
 Beam opening: 40°  
 Light intensity: 580 Lux at 3 m  
 Infrared remote control  
 Digital display with drop-down menu  
 Input and output on IEC plugs  
 Modes of operation:  
 2-9 channel DMX, fixed colours, Step or Fade programs, Auto mode with sound sensitivity, Slave Mode, Editing and playback of a 20-step program  
 Power consumption: 80 W  
 Power supply: AC 100/240V - 50/60Hz  
 DMX input and output  
 Dimensions: 240 x 265 x 110 mm  
 Net weight: 2.8 kg











**irLDFLAT**  
**5x12fXb-Air**  
 5 DMX six-colour wireless LEDs

Code : H10525      199€ incl. VAT



5x12W six-colour RGBWA + UV LEDs  
 Beam opening: 40°  
 Light intensity: 580 Lux at 3 m  
 Wireless airDMX embedded transmitter and receiver. 2.4-GHz frequency band  
 Compatible with AirBox-ER1 housing  
 Infrared remote control  
 Digital display with drop-down menu  
 Input and output on IEC plugs  
 Modes of operation:  
 2-9 channel DMX, fixed colours, Step or Fade programs, Auto mode with sound sensitivity, Slave Mode, Editing and playback of a 20-step program  
 Power consumption: 80 W  
 Power supply: AC 100/240V - 50/60Hz  
 DMX input and output  
 Dimensions: 240 x 265 x 110 mm  
 Net weight: 2.8 kg





**irLEDFLAT-3x12SIXb**  
 Six-colour LEDs, 3x12W LEDs



Code : H10141      129€ incl. VAT



3x12W six-colour RGBWA + UV LEDs  
 Beam opening: 40°  
 Light intensity: 300 Lux at 3 m  
 Infrared remote control  
 Digital display with drop-down menu  
 Input and output on IEC plugs  
 Modes of operation:  
 2-9 channel DMX, fixed colours, Step or Fade programs, Auto mode with sound sensitivity, Slave Mode, Editing and playback of a 20-step program  
 Power consumption: 45 W  
 Power supply: AC 100/240V - 50/60Hz  
 DMX input and output  
 Dimensions: 212 x 218 x 110 mm  
 Net weight: 2.1 kg

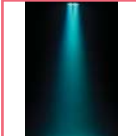



**IP20**

**30°**

**LED PLANO 7FC-BLACK**  
7x8W RGBW LEDs

Code : B04958      129€ incl. VAT



7x8W RGBW LEDs  
Beam opening: 30°  
Infrared remote control  
Ready for a DMX wireless connection with the WTR-DMX option  
Digital display with drop-down menu  
Input and output on IEC plugs  
Modes of operation:  
Standalone, Master/slave mode, DMX mode, usable with LEDCON-02 or LEDCON-XL controllers  
DMX input and output  
Finish: black  
Power consumption: 38 W  
Power supply: AC 100/240V - 50/60Hz  
Dimensions: 210 x 120 x 220 mm  
Net weight: 2.35 kg





**IP20**



**30°**



**LED PLANO 7FC-WHITE**  
7x8W RGBW LEDs

Code : B04959      129€ incl. VAT



7x8W RGBW LEDs  
Beam opening: 30°  
Infrared remote control  
Ready for a DMX wireless connection with the WTR-DMX option  
Digital display with drop-down menu  
Input and output on IEC plugs  
Modes of operation:  
Standalone, Master/slave mode, DMX mode, usable with LEDCON-02 or LEDCON-XL controllers  
DMX input and output  
Finish: white  
Power consumption: 38 W  
Power supply: AC 100/240V - 50/60Hz  
Dimensions: 210 x 120 x 220 mm  
Net weight: 2.35 kg







**IP20**

**10°**



**irLEDFLAT**  
**5x5QCb10°-Air**  
5 10° 4-colour LEDs with wireless DMX

Code : H10527      199€ incl. VAT



5x5W RGBW LEDs  
Beam opening: 10°  
Light intensity: 640 Lux at 3 m  
Wireless airDMX embedded transmitter and receiver. 2.4-GHz frequency band  
Compatible with AirBox-ER1  
Infrared remote control  
Digital display with drop-down menu  
Input and output on IEC plugs  
Modes of operation:  
2-7 channel DMX, Fixed colours, Step or Fade programs, Auto mode with sound sensitivity, Slave Mode, Editing and playback of a 20-step program  
Power consumption: 30 W  
Power supply: AC 100/240V - 50/60Hz  
DMX input and output  
Dimensions: 240 x 265 x 110 mm  
Net weight: 2.8 kg



**IP20**

**40°**

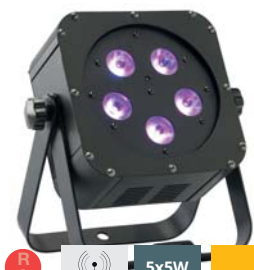

**irLEDFLAT-5x5QCb**  
5x5W RGBW LEDs - Black finish - Infrared remote control

Code : H9917      149€ incl. VAT



5x5W RGBW LEDs  
Beam opening: 40°  
Light intensity: 640 Lux at 3 m  
Infrared remote control  
Digital display with drop-down menu  
Input and output on IEC plugs  
Modes of operation:  
2-7 channel DMX, Fixed colours, Step or Fade programs, Auto mode with sound sensitivity, Slave mode  
Power consumption: 30 W  
Power supply: AC 100/240V - 50/60Hz  
DMX input and output  
Dimensions: 240 x 265 x 110 mm  
Net weight: 2.8 kg



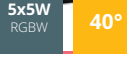

**IP20**

**40°**

**irLEDFLAT-5x5QCb-Air**  
5x5W RGBW wireless DMX LEDs

Code : H10524      179€ incl. VAT



5x5W RGBW LEDs  
Beam opening: 40°  
Light intensity: 640 Lux at 3 m  
Wireless airDMX embedded transmitter and receiver. 2.4-GHz frequency band  
Compatible with AirBox-ER1 housing  
Infrared remote control  
Digital display with drop-down menu  
Input and output on IEC plugs  
Modes of operation:  
2-7 channel DMX, Fixed colours, Step or Fade programs, Auto mode with sound sensitivity, Slave Mode, Editing and playback of a 20-step program  
Power consumption: 30 W  
Power supply: AC 100/240V - 50/60Hz  
DMX input and output  
Dimensions: 240 x 265 x 110 mm  
Net weight: 2.8 kg





**IP20**

**25°**

**irLEDFLAT-5x5QCb25°**  
Compact projector with 5W RGBW LEDs Black finish - infrared remote control - 25°



Code : H9973      169€ incl. VAT



5x5W RGBW LEDs  
Beam opening: 25°  
Light intensity: 640 Lux at 3 m  
Infrared remote control  
Digital display with drop-down menu  
Input and output on IEC plugs  
Modes of operation:  
2-7 channel DMX, Fixed colours, Step or Fade programs, Auto mode with sound sensitivity, Slave mode  
Power consumption: 30 W  
Power supply: AC 100/240V - 50/60Hz  
DMX input and output  
Dimensions: 240 x 265 x 110 mm  
Net weight: 2.8 kg



# FLAT PROJECTORS

**30W**  
COB

**9x4W**  
RGB UV

**10W**  
STROBE

**RAVE SPOT**  
3 effects in a single device. Wireless DMX

Code : B06201      149€ incl. VAT



3 effects in a single device!  
9 x4W RGB UV LEDs  
1 central 30W RGB COB LED.  
Strobe LED: 21x0,5 W white LEDs.  
Infrared remote control  
Ready for a DMX wireless connection with the WTR-DMX option  
Digital display with drop-down menu  
Input and output on IEC plugs  
Modes of operation: Standalone, Master/slave mode, 1-22 channel DMX mode  
DMX input and output  
Power consumption: 78 W  
Power supply: AC 100/240V - 50/60Hz  
Dimensions: 280 x 275 x 76 mm  
Net weight: 1.81 kg

**IP20**

**7x8W**  
RGBW

**PARTY SPOT**  
7x8W RGBW compact LEDs

Code : B04189      79€ incl. VAT



7x8W RGBW LEDs  
Digital display with drop-down menu  
Input and output on IEC plugs  
Modes of operation:  
Standalone, Master/slave mode, DMX mode, usable with LEDCON-02 or LED-CON-XL controllers  
DMX input and output  
Power consumption: 38 W  
Power supply: AC 100/240V - 50/60Hz  
Dimensions: 190 x 190 x 140 mm  
Net weight: 1.48 kg



**IP20**

**100W**  
COB

**70°**  
**15°**

**COB SLIM100-RGB**  
Energy efficient compact COB LED projector!

Code : B04415      289€ incl. VAT



1x100W RGB COB LED  
Beam opening: 15° or 70°  
Light intensity: 1165 Lux at 3 m at 15°  
Ready for a DMX wireless connection with the WTR-DMX option  
Infrared remote control  
Digital display with drop-down menu  
Mains input/output on Powercon plugs  
Modes of operation:  
Standalone, Master/slave, DMX mode, usable with LEDCON-02 MK2 controllers  
Power consumption: 120 W  
Power supply: AC 100/240V - 50/60Hz  
DMX input and output  
Dimensions: 245 x 280 x 140 mm  
Net weight: 3.46 kg



**IP20**

**36W**  
COB



**100°**  
**15°**

**COB-PLANO**  
36W RGB COB, 100°+15°

Code : B04951      139€ incl. VAT



1x36W RGB COB LED  
Beam opening: 15° or 100°  
Infrared remote control  
Digital display with drop-down menu  
Input and output on IEC plugs  
Modes of operation:  
Standalone, Master/slave, DMX mode, usable with LEDCON-02 MK2 controllers  
Power consumption: 40 W  
Power supply: AC 100/240V - 50/60Hz  
DMX input and output  
Dimensions: 202 x 120 x 224 mm  
Net weight: 2.14 kg

**IP20**

**30W**  
COB

**25°**  
**80°**

**irLEDFLAT-1x30TCb**  
30W compact COB LED projector with FROST diffuser filter

Code : H10130      129€ incl. VAT



1x30W RGB COB LED  
Beam opening: 25° or 80°  
Light intensity: 410 Lux at 3 m at 25°  
Digital display with drop-down menu  
Input and output on IEC plugs  
Modes of operation:  
2-6 channel DMX, Fixed colours, Step or Fade programs, Auto mode with sound sensitivity, Slave mode, Editing and playback of a 20-step program  
Power consumption: 45 W  
Power supply: AC 100/240V - 50/60Hz  
DMX input and output  
Dimensions: 208 x 221 x 120 mm  
Net weight: 2.1 kg



**4x36W**  
COB RGB

**15°**  
**100°**

**COB-4BAR**  
4xCOB RGB 36W + IR + Flight case

Code : B04952      399€ incl. VAT



4x1 36W RGB COB LED  
Beam opening: 15° or 100°  
Infrared remote control  
Ready for a DMX wireless connection with the WTR-DMX option  
Digital display with drop-down menu  
Input and output on IEC plugs  
Modes of operation:  
Standalone, Master/slave, DMX mode, usable with LEDCON-02 MK2 or COB-4BAR FOOTCONTROL controllers  
Power consumption: 120 W  
Power supply: AC 100/240V - 50/60Hz  
DMX input and output  
Dimensions: 1000 x 82 x 320mm  
Net weight: 11 kg



**COB-4BAR FOOT-CONTROL**

Pedal assembly for COB-4BAR

Code : B04953 44.90€ incl. VAT



**LIVESET**

Bar with 4 projectors with 3x9W RGB LEDs and 4x1W white flash LEDs

Code : H10482 279€ incl. VAT



**MINISET**

Animation light bar with 4 projectors

Code : H10201 239€ incl. VAT



12x9W tricolour LEDs  
4x1W white LEDs (strobe)  
Beam opening: 15°  
WIFI pedal assembly  
Modes of operation: DMX, Standalone, Musical, Master/slave  
1.5m-2m adjustable tripod  
Transport bag for light bar+pedal assembly  
Carrying case for the tripod supplied  
Power supply: 100-240V 50/60Hz  
Power consumption: 108W  
Dimensions: 1032 x 70 x 235 mm  
Net weight: 10.2 kg

12x9W tricolour LEDs  
Beam opening: 15°  
Pedal assembly for Blackout and programs  
Modes of operation: DMX, Standalone, Musical, Master/slave  
1.5m-2m adjustable tripod  
Transport bag for light bar+pedal assembly  
Carrying case for the tripod supplied  
Power supply: 100-240V 50/60Hz  
Power consumption: 55W  
Dimensions: 910 x 242 x 50 mm  
Net weight: 10 kg



**CASE for 4x COB-PLANO**

4x COB-PLANO + 1x LEDCON-02 Mk2

Code : B03252 119€ incl. VAT



Lightweight and compact case designed for 4x COB-PLANO + LEDCON-02 Mk2  
External dimensions: 550 x 315 x 250 mm



**LIGHT EFFECT CASE 1**

Solid flight case for the transport of light effects.

Code : B03216 179€ incl. VAT



Solid flight case for transport  
Divided into 5 compartments:  
2x compartments (465x285x260mm)  
1x compartment (190x69x260mm)  
1x compartment (150x69x260mm)  
1x compartment (95x69x260mm)



**CASE for COB-4BAR**

Lightweight and compact case, specially designed to carry a COB-4BAR

Code : B03249 129€ incl. VAT



Lightweight and compact case, specially designed to carry a COB-4BAR  
External dimensions: 105 x 34 x 16 cm





**FLY8-irLEDFLAT**

Flight case for 8x FLAT12SIX

Code : H10739 429€ incl. VAT



# PAR PROJECTORS



**irLED64-18x12fXsb-Air**  
PAR64 with 18 RGBWAUV LEDs - Wireless DMX

Code : H10532      399€ incl. VAT



18x12W six-colour RGBWA + UV LEDs  
Beam opening: 40°  
Light intensity: 3350 Lux at 3 m  
Wireless airDMX embedded transmitter and receiver: 2.4-GHz frequency band  
Compatible with AirBox-ER1  
Infrared remote control  
Digital display with drop-down menu  
Input and output on IEC plugs  
Modes of operation:  
2-9 channel DMX, fixed colours, Step or Fade programs, Auto mode with sound sensitivity, Slave Mode, Editing and playback of a 20-step program  
Power consumption: 240 W  
Power supply: AC 100/240V - 50/60Hz  
DMX input and output  
Black aluminium housing  
Dimensions: 340 x 270 x 220 mm  
Net weight: 5.4 kg



**irLED64-18x12SIXsb**  
PAR64 with RGBWAUV LEDs - With infrared remote control

Code : H10138      369€ incl. VAT



18x12W six-colour RGBWA + UV LEDs  
Beam opening: 40°  
Light intensity: 3350 Lux at 3 m  
Infrared remote control  
Digital display with drop-down menu  
Input and output on IEC plugs  
Modes of operation:  
2-9 channel DMX, Fixed colours, Step or Fade programs, Auto mode with sound sensitivity, Slave Mode, Editing and playback of a 20-step program  
Power consumption: 240 W  
Power supply: AC 100/240V - 50/60Hz  
DMX input and output  
Black aluminium housing  
Dimensions: 340 x 270 x 220 mm  
Net weight: 5.4 kg









**irLED64-18x12SIXss**  
PAR64 with RGBWAUV LEDs - With infrared remote control - Aluminium

Code : H10137      369€ incl. VAT



18x12W six-colour RGBWA + UV LEDs  
Beam opening: 40°  
Light intensity: 3350 Lux at 3 m  
Infrared remote control  
Digital display with drop-down menu  
Input and output on IEC plugs  
Modes of operation:  
2-9 channel DMX, Fixed colours, Step or Fade programs, Auto mode with sound sensitivity, Slave Mode, Editing and playback of a 20-step program  
Power consumption: 240 W  
Power supply: AC 100/240V - 50/60Hz  
DMX input and output  
Silver aluminium housing  
Dimensions: 340 x 270 x 220 mm  
Net weight: 5.4 kg







**irLED64-18x10FIVEsb**  
PAR64 with 18x10W 5-colour LEDs  
Black finish

Code : H10072      339€ incl. VAT



18x10W RGB White + Amber LEDs  
Beam opening: 40°  
Light intensity: 2150 Lux at 3 m  
Infrared remote control  
Digital display with drop-down menu  
Input and output on IEC plugs  
Modes of operation:  
2-8 channel DMX, Fixed colours, Step or Fade programs, Auto mode with sound sensitivity, Slave mode, Editing and playback of a 20-step program  
Power consumption: 165 W  
Power supply: AC 100/240V - 50/60Hz  
DMX input and output  
Black aluminium housing  
Dimensions: 340 x 270 x 220 mm  
Net weight: 4.6 kg

**irLED64-18x10FIVEss**  
PAR64 with 18x10W 5-colour LEDs - Aluminium finish

Code : H10073      339€ incl. VAT



18x10W RGB White + Amber LEDs  
Beam opening: 40°  
Light intensity: 2150 Lux at 3 m  
Infrared remote control  
Digital display with drop-down menu  
Input and output on IEC plugs  
Modes of operation:  
2-8 channel DMX, Fixed colours, Step or Fade programs, Auto mode with sound sensitivity, Slave mode, Editing and playback of a 20-step program  
Power consumption: 165 W  
Power supply: AC 100/240V - 50/60Hz  
DMX input and output  
Silver aluminium housing  
Dimensions: 340 x 270 x 220 mm  
Net weight: 4.6 kg







18x3W RGB 40°

**irLED64-18x3TCsb**  
PAR64 with 18x3W TRI LEDs Black finish

Code : H9876 199€ incl. VAT



18x3W RGB LEDs  
Beam opening: 40°  
Light intensity: 1150 Lux at 3 m  
Infrared remote control  
Digital display with drop-down menu  
Input and output on IEC plugs  
Modes of operation:  
2-6 channel DMX, Fixed colours, Step or Fade programs, Auto mode with sound sensitivity, Slave mode,  
Power consumption: 60 W  
Power supply: AC 100/240V - 50/60Hz  
DMX input and output  
Black aluminium housing  
Dimensions: 340 x 270 x 220 mm  
Net weight: 4.3 kg

18x3W RGB 40°

**irLED64-18x3TCss**  
PAR64 with 18x3W TRI LEDs Aluminium finish

Code : H9875 199€ incl. VAT



18x3W RGB LEDs  
Beam opening: 40°  
Light intensity: 1150 Lux at 3 m  
Infrared remote control  
Digital display with drop-down menu  
Input and output on IEC plugs  
Modes of operation:  
2-6 channel DMX, Fixed colours, Step or Fade programs, Auto mode with sound sensitivity, Slave mode,  
Power consumption: 60 W  
Power supply: AC 100/240V - 50/60Hz  
DMX input and output  
Silver aluminium housing  
Dimensions: 340 x 270 x 220 mm  
Net weight: 4.3 kg





**FLY-irLED64x6**  
Flight case for 6 PAR64

Code : H10338 429€ incl. VAT



External dimensions - L x W x H:  
850 x 580 x 585 mm  
Compartment dimensions:  
260 x 260 mm Depth: 440 mm  
Hood thickness: 65 mm



12x3W RGB 40°

**irLED56-12x3TCsb**  
PAR56 with 12x3W TRI LEDs - Black finish

Code : H9872 149€ incl. VAT



12x3W RGB LEDs  
Beam opening: 40°  
Light intensity: 1030 Lux at 3 m  
Infrared remote control  
Digital display with drop-down menu  
Input and output on IEC plugs  
Modes of operation:  
2-6 channel DMX, Fixed colours, Step or Fade programs, Auto mode with sound sensitivity, Slave mode,  
Power consumption: 40 W  
Power supply: AC 100/240V - 50/60Hz  
DMX input and output  
Black aluminium housing  
Dimensions: 360 x 270 x 170 mm  
Net weight: 2.8 kg

12x3W RGB 40°

**irLED56-12x3TCss**  
PAR56 projector with 12 3W TRI LEDs Aluminium finish - Infrared remote control

Code : H9871 149€ incl. VAT



12x3W RGB LEDs  
Beam opening: 40°  
Light intensity: 1030 Lux at 3 m  
Infrared remote control  
Digital display with drop-down menu  
Input and output on IEC plugs  
Modes of operation:  
2-6 channel DMX, Fixed colours, Step or Fade programs, Auto mode with sound sensitivity, Slave mode,  
Power consumption: 40 W  
Power supply: AC 100/240V - 50/60Hz  
DMX input and output  
Silver aluminium housing  
Dimensions: 360 x 270 x 170 mm  
Net weight: 2.8 kg



12x12W RGBWAUV 15°

**BT-STAGEPAR 6in1**  
12x12W RGBWA projector + UV - 15°

Code : B04377 339€ incl. VAT



12x12W six-colour RGBWA + UV LEDs  
Beam opening: 25°  
Digital display with drop-down menu  
Mains output on IEC plugs  
Modes of operation:  
1-9 channel DMX, Fixed colours, Step or Fade programs, Auto mode with sound sensitivity, Slave mode,  
Mode: Halogen lamp or Diode  
White balance  
Remote setup: RDM  
Power supply: AC 100/240V - 50/60Hz  
DMX input and output  
finish: black  
Dimensions: 300 x 275 x 300 mm  
Net weight: 3.5 kg



# PAR PROJECTORS



**CW** **100W** **60°**  
5600k

**COB PAR56-100CW BLACK**  
LED projector with parabolic reflector

Code : B04409 329€ incl. VAT



Optics: 1x100W 5600K COB LED  
Opening angle: 60°  
Digital display with drop-down menu  
Mains output on IEC plugs  
Modes of operation:  
1-2 channel DMX, Fixed colours, Step or Fade programs, Auto mode with sound sensitivity, Slave mode,  
Mode: Halogen lamp or Diode  
Power supply: 100-240V/50-60Hz  
DMX input and output  
Finish: black  
Dimensions: 417 x 286 x 260 mm  
Weight: 2.8 kg



**CW** **100W** **60°**  
5600K

**SILVER COB PAR56-100CW**  
LED projector with parabolic reflector

Code : B04408 329€ incl. VAT



Optics: 1x100W 5600K COB LED  
Opening angle: 60°  
Digital display with drop-down menu  
Mains output on IEC plugs  
Modes of operation:  
1-2 channel DMX, Fixed colours, Step or Fade programs, Auto mode with sound sensitivity, Slave mode,  
Mode: Halogen lamp or Diode  
Power supply: 100-240V/50-60Hz  
DMX input and output  
Finish: silver  
Delivered with 25° lens, filter door  
Dimensions: 417 x 286 x 260 mm  
Weight: 2.8 kg



**WW** **100W** **60°**  
3200K

**BLACK COB PAR56-100WW**  
LED projector with parabolic reflector

Code : B04411 329€ incl. VAT



Optics: 1x100W 3200K COB LED  
Opening angle: 60°  
Digital display with drop-down menu  
Mains output on IEC plugs  
Modes of operation:  
1-2 channel DMX, Fixed colours, Step or Fade programs, Auto mode with sound sensitivity, Slave mode,  
Mode: Halogen lamp or Diode  
Power supply: 100-240V/50-60Hz  
DMX input and output  
Finish: black  
Delivered with 25° lens, filter door  
Dimensions: 417 x 286 x 260 mm  
Weight: 2.8 kg



**WW** **100W** **60°**  
3200K

**SILVER COB PAR56-100WW**  
LED projector with parabolic reflector

Code : B04410 329€ incl. VAT



Optics: 1x100W 3200K COB LED  
Opening angle: 60°  
Digital display with drop-down menu  
Mains output on IEC plugs  
Modes of operation:  
1-2 channel DMX, Fixed colours, Step or Fade programs, Auto mode with sound sensitivity, Slave mode,  
Mode: Halogen lamp or Diode  
Power supply: 100-240V/50-60Hz  
DMX input and output  
Finish: silver  
Delivered with 25° lens, filter door  
Dimensions: 417 x 286 x 260 mm  
Weight: 2.8 kg



**R** **G** **B** **100W** **50°**  
COB RGB

**PAR56-RGB COB**  
100xW RGB COB LED

Code : B04403 309€ incl. VAT



Optics: 1x100W RGB COB LED  
Opening angle: 50°  
Digital display with drop-down menu  
Mains output on IEC plugs  
Modes of operation:  
3-, 4- and 5-channel DMX, Fixed colours, Step or Fade programs, Auto mode with sound sensitivity, Slave mode,  
Power supply: 100-240V/50-60Hz  
DMX input and output  
Finish: black  
Delivered with 25° lens, filter door  
Dimensions: 417 x 286 x 260 mm  
Weight: 2.8 kg



**COB BARNDOOR/Black**  
Barndoor for COB PAR56

Code : B04413 34.90€ incl. VAT





**COB BARNDOOR/Silver**  
Barndoor for COB PAR56

Code : B04414 34.90€ incl. VAT



**PROJECTOR CASE**  
Flight case for carrying 4 projectors

Code : B03253 299€ incl. VAT



For:  
BRITEQ COB-PAR  
BRITEQ BT-Stagepar 6in1  
BRITEQ BT-Theatre 1EZ  
BRITEQ BT-Theatre 100EC







**RETRO-PAR20 RGBW**  
15W RGBW RETRO-PAR20 LED IR Remote Control

Code : B05129      64,90€ incl. VAT



RETRO-PAR20 LED projector  
1x15W RVBW LED.  
Opening: 10°  
Infrared remote control IR-3  
16 fixed colours (with dimming).  
"Fade", "soft transition" and "flash"  
colour interlacing (with speed control).  
Strobe function (with speed control).  
Easy to use sound control mode.  
Power supply: 100-240V/50-60Hz  
finish: black  
Dimensions: 198 x 112 x 100 mm  
Weight: 0.65 kg



**PIN15QC**  
4° beam projector with 15W 4-colour LEDs

Code : H10595      129€ incl. VAT



1x15W RGBW LED  
Openings: 4° | 10° | 45°  
Power consumption: 17 W  
Power supply: AC100V-240V. 60Hz-50Hz  
IEC IN/OUT  
DMX 3-pin IN/OUT  
Automatic or music programs DMX  
Control: 1,4,7,12 channels  
Infrared remote control  
Dimensions: 135 x 203 x 172 mm  
Net weight: 1.4 kgs



**PIN15W**  
4° beam projector with 15W warm white LED

Code : H10709      129€ incl. VAT



1x15W warm white LED  
Openings: 4° | 10° | 45°  
Power consumption: 17 W  
Power supply: AC100V-240V. 60Hz-50Hz  
IEC IN/OUT  
DMX 3-pin IN/OUT  
Automatic or music programs DMX  
Control: 1, 2 channels  
Infrared remote control  
Dimensions: 135 x 203 x 172 mm  
Net weight: 1.4 kgs



**BEAMSPOT1-DMX FC**  
15W RGBW projector, equipped with a very narrow 4° lens

Code : B04957      139€ incl. VAT



1x15W RGBW LED  
Openings: 4° | 10° | 45°  
Power consumption: 17 W  
Power supply: AC100V-240V. 60Hz-50Hz  
Powercon IN/OUT  
DMX 3-pin IN/OUT  
DMX control: 4-7 channels  
Dimensions: 125 x 196 x 172 mm  
Net weight: 1.23 kgs



**BEAMSPOT1-DMX NW**  
15W WHITE projector equipped with a very narrow 4° lens.

Code : B04956      139€ incl. VAT



1x15W natural white 4500K LED  
Openings: 4° | 10° | 45°  
Power consumption: 17 W  
Power supply: AC100V-240V. 60Hz-50Hz  
Powercon IN/OUT  
DMX 3-pin IN/OUT  
DMX control: 1-2 channels  
Dimensions: 125 x 196 x 172 mm  
Net weight: 1.23 kgs





**BEAMSPOT1-DMX WW**  
15W WARM WHITE 4° lens

Code : B04960      139€ incl. VAT



1x15W warm white 3200K LED  
Openings: 4° | 10° | 45°  
Power consumption: 17 W  
Power supply: AC100V-240V. 60Hz-50Hz  
Powercon IN/OUT  
DMX 3-pin IN/OUT  
DMX control: 1-2 channels  
Dimensions: 125 x 196 x 172 mm  
Net weight: 1.23 kgs

# PAR PROJECTORS

NW

15W

4°

**BEAMSPOT1-TRIAC NW**  
15W WHITE projector



---

Code : B04955      85€ incl. VAT

---



1x15W natural white 4500K LED  
 Openings: 4° | 10° | 45°  
 NO DMX: can be controlled using a traditional triac dimmer / triac light modulator or the dimmer located on the rear panel.  
 Power consumption: 17 W  
 Power supply: AC100V-240V. 60Hz-50Hz  
 Fixed power cord with standard power outlet  
 Dimensions: 125 x 196 x 172 mm  
 Net weight: 1.23 kgs

WW

15W

4°

**BEAMSPOT1-TRIAC WW**  
This 15W PINSPO

---

Code : B04954      85€ incl. VAT

---



1x15W warm white 3200K LED  
 Openings: 4° | 10° | 45°  
 NO DMX: can be controlled using a traditional triac dimmer / triac light modulator or the dimmer located on the rear panel.  
 Power consumption: 17 W  
 Power supply: AC100V-240V. 60Hz-50Hz  
 Fixed power cord with standard power outlet  
 Dimensions: 125 x 196 x 172 mm  
 Net weight: 1.23 kgs



**LED PINSPO**  
3W white LED projector, lenses incl. 6° + 11°

---

Code : B04918      49€ incl. VAT

---



1x3W LED  
 Openings: 6° | 11°  
 Power consumption: 8 W  
 Power supply: AC100V-240V. 60Hz-50Hz  
 Fixed power cord with standard power outlet  
 Dimensions: 104 x 78 x 55 mm  
 Net weight: 0.44 kgs





**PAR46/black**  
PAR 46 with black E27 socket.

---

Code : B02066      32,90€ incl. VAT

---



Ideal for stores and showrooms!  
 Power cord included  
 E27 socket for PAR 38 lamp (lamp not included)  
 Filter holder included  
 Finish: black  
 Total length without holder: 31cm barn-door option available



**PAR46/silver**  
PAR 46 with chrome-coloured E27 socket.

---

Code : B02053      32,90€ incl. VAT

---



Ideal for stores and showrooms!  
 Power cord included  
 E27 socket for PAR 38 lamp (lamp not included)  
 Filter holder included  
 Finish: silver  
 Total length without holder: 31cm barn-door option available



**PAR46-BARN/black**  
Barndoor for PAR46

Code : B02079 19,90€ incl. VAT



**PAR46-BARN/silver**  
Barndoor for PAR46

Code : B02080 19,90€ incl. VAT



**PINSPOT/Black**  
Projector for PAR36 lamp

Code : B02034 17,90€ incl. VAT



Projector for 30W/6V PAR 36 lamp  
Equipped with a transformer, fuse holder and clips to fix the lamp  
Finish: black  
Without lamp



**PAR30/black**  
Projector for PAR30 or PAR20 lamp

Code : B02088 19€ incl. VAT



**PAR30/silver**  
Projector for PAR30 or PAR20 lamp

Code : B02087 19€ incl. VAT



**PAR30-BARN/black**  
Barndoor for PAR30

Code : B02077 14,90€ incl. VAT



**PAR30-BARN/silver**  
Barndoor for PAR30

Code : B02078 14,90€ incl. VAT



Projector for Par 30 or Par 20 lamp  
Compatible with halogen lamps and E27 socket LED lamps  
Power supply 230V AC  
Finish: black  
Total length without holder: 22 cm  
Without lamp

Projector for Par 30 or Par 20 lamp  
Compatible with halogen lamps and E27 socket LED lamps  
Power supply 230V AC  
Finish: silver  
Total length without holder: 22 cm  
Without lamp



# PAR PROJECTORS



**PAR20/black**  
Projector for PAR20 lamp

Code : B02086 14.90€ incl. VAT



Projector for PAR20 lamp  
Finish: black  
Total length without holder: 17cm  
Without lamp



**PAR20/silver**  
Projector for PAR20 lamp

Code : B02085 14.90€ incl. VAT



Projector for PAR20 lamp  
Finish: silver  
Total length without holder: 17cm  
Without lamp



**PAR20-BARN/black**  
Barndoor for PAR20

Code : B02075 12.90€ incl. VAT



**PAR20-BARN/silver**  
Barndoor for PAR20

Code : B02076 12.90€ incl. VAT



**PAR16/black GU10 socket**  
Projector for PAR16 lamp

Code : B02061 13.90€ incl. VAT



GU10 socket for the use of: LED lamps (GU10) Halogen lamp (35W or 50W/230V)  
Finish: black  
No transformer necessary  
Total length without holder: 14.5cm  
Without lamp



**PAR16/Silver GU10 socket**  
Projector for PAR16 lamp

Code : B02055 13.90€ incl. VAT



GU10 socket for the use of: LED lamps (GU10) Halogen lamp (35W or 50W/230V)  
Finish: silver  
No transformer necessary  
Total length without holder: 14.5cm  
Without lamp



**PAR16-BARN/black**  
Barndoor for PAR16

Code : B02073 11.90€ incl. VAT



**PAR16-BARN/silver**  
Barndoor for PAR16

Code : B02074 11.90€ incl. VAT



**TF36**  
Transformer for PAR36 lamp (30W/6V)

Code : B02045 9.90€ incl. VAT



# Artist10W

La projection gobo sur-mesure\*

\*Tailor-made gobo projection



I love  
you  
Mary



by **Contest**



# PANELS, BLINDERS AND FLOOD

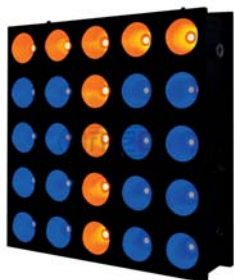

**POWERMATRIX5x5-RGB Mk2**  
25 30W RGB COB LED Flood Projector

Code : B04412 1329€<sup>Incl. VAT</sup>



25 COB LEDs  
30W tri-colour LEDs  
Beam opening: 60°  
Neutrik® PowerCon inputs/outputs  
DMX 3 and 5-pin inputs/outputs. Consumption: 750W  
Power supply: AC 100/240V - 50/60Hz  
Cooling by temperature regulated ventilation  
Dimensions: 55 x 55 x 12 cm  
Net weight: 14.5 kg



**POWERMATRIX5x5-BRACKET**  
Suspensions for POWERMATRIX5x5 RGB, POWERMATRIX5x5 RGB Mk2, ...

Code : B04407 29€<sup>Incl. VAT</sup>



Specially designed for suspension of POWERMATRIX5x5 RGB projectors  
Perfect for mounting several POWERMATRIX5x5 RGB in structures in matrix form  
Robust metal design with additional reinforcements Equipped with a special "coffin lock" mechanism for quick and easy installation.



**POWERMATRIX5x5-CASE**  
Flight case for 6x PowerMatrix5x5

Code : B04406 339€<sup>Incl. VAT</sup>



**PIX44**  
16 30W TRI COB LED Flood Projector With LCD display

Code : H10016 849€<sup>Incl. VAT</sup>



16 COB LEDs  
30W tri-colour LEDs  
Beam opening: 60°  
DMX 3- and 5-pin XLR input and output  
Power input and output on PowerCON (maximum 5 projectors connected to each other)  
Power consumption: 500W  
Power supply: AC 100/240V - 50/60Hz  
Cooling by temperature regulated ventilation  
Dimensions: 345 x 345 (365 with the moving head) x 180 mm  
Net weight: 8.25 Kg



**PIX18**  
Bar with 8 30W TRI COB LEDs  
With LCD display

Code : H10018 559€<sup>Incl. VAT</sup>



8 COB LEDs  
30W tri-colour LEDs  
Beam opening: 60°  
DMX 3- and 5-pin XLR input and output  
Power input and output on PowerCON® (maximum 10 projectors connected to each other)  
Power consumption: 240 W  
Power supply: AC 100/240V - 50/60Hz  
Cooling by temperature regulated ventilation  
Dimensions: 880 x 60 x 170 mm  
Net weight: 8 Kg



**Powerpixel8-RGB**  
Bar with 8 30W TRI COB LEDs  
With LCD display

Code : B04401 559€<sup>Incl. VAT</sup>



8 COB LEDs  
30W tri-colour LEDs  
Beam opening: 60°  
DMX 3- and 5-pin XLR input and output  
Power input and output on PowerCON® (maximum 10 projectors connected to each other)  
Power consumption: 240 W  
Power supply: AC 100/240V - 50/60Hz  
Cooling by temperature regulated ventilation  
Dimensions: 880 x 60 x 170 mm  
Net weight: 8 Kg



**PIX14**  
Bar with 4 30W TRI COB LEDs  
With LCD display

Code : H10017 399€<sup>Incl. VAT</sup>



4 COB LEDs  
30W tri-colour LEDs  
Beam opening: 60°  
DMX 3- and 5-pin XLR input and output  
Power input and output on PowerCON® (maximum 20 projectors connected to each other)  
Power consumption: 120 W  
Power supply: AC 100/240V - 50/60Hz  
Cooling by temperature regulated ventilation  
Dimensions: 440 x 150 x 180 mm  
Net weight: 5 Kg



**Powerpixel4-RGB**  
Bar with 4 30W TRI COB LEDs  
With LCD display

Code : B04400 399€<sup>Incl. VAT</sup>



4 COB LEDs  
30W tri-colour LEDs  
Beam opening: 60°  
DMX 3- and 5-pin XLR input and output  
Power input and output on PowerCON® (maximum 20 projectors connected to each other)  
Power consumption: 120 W  
Power supply: AC 100/240V - 50/60Hz  
Cooling by temperature regulated ventilation  
Dimensions: 440 x 150 x 180 mm  
Net weight: 5 Kg



### PROJECTOR CASE 2

Flight case for POWERPIXEL8-RGB, POWERPIXEL4-RGB, BEAMBAR10-RGBW, BEAMBAR5-RGBW

Code : B03257 599<sup>incl. VAT</sup>



### COB Blinder 2x100W

LED BLINDER equipped with two white 100Watt LED projectors

Code : B04402 559<sup>incl. VAT</sup>



### BEAM MATRIX5x5-RGBW

5x5 MATRIX effect, 25x 15W RGBW 4.5°beams + Artnet

Code : B04416 1190<sup>incl. VAT</sup>



LED BLINDER equipped with two white 100Watt 3200k LED projectors  
Opening angle: 60°  
The two projectors can be controlled independently  
DMX mode: 1, 2 or 4 channels  
Static mode: Stroboscopic effect  
dimmer Master/Slave Mode, Variable stroboscopic effect  
Halogen (slow) or LED (fast) mode  
Dimming 16 bit from 0% to 100%  
DMX IN/OUT on XLR 3/5-pin plug  
POWER IN/OUT with Powercon  
Power: AC 100 - 240V, 50/60Hz  
Power consumption: 235W  
Dimensions: 440 x 144 x 355 mm  
Weight: 4.46 kg

25 15W RGBW LEDs 5x5 Matrix  
Lens opening: 4.5°  
DMX mode: 4-150 channels  
Ethernet input/output: Art-Net support  
Internal programs in standalone mode or via DMX, Master/slave mode, static or fade colours, static or sound-triggered chasers.  
Halogen (slow) or LED (fast) mode  
Balancing of individual whites by Pixel  
Four intensity variation curves  
DMX IN/OUT on XLR 3/5-pin plug  
POWER IN/OUT with Powercon  
Power: AC 100 - 240V, 50/60Hz  
Power consumption: 415W  
Dimensions: 550 x 550 x 120 mm  
Weight: 18 kg



### MATRIX5x5-CASE

Flight case for 6x MATRIX5x5

Code : B04422 339<sup>incl. VAT</sup>



# PANELS, BLINDERS AND FLOOD

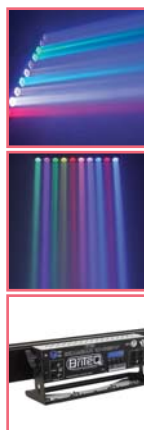

**BEAMBAR10-RGBW**  
LED Narrow Beam Bar, 10x 15W RGBW  
Osram + Artnet

Code : B04418 799€<sup>Incl. VAT</sup>



10 15W RGBW Osram LEDs  
Lens opening: 4.5°  
Frost filter: included  
DMX mode: 3-60 channels  
Ethernet input/output: Art-Net support  
Internal programs in standalone mode or via DMX, Master/slave mode, static or fade colours, static or sound-triggered chasers.  
Halogen (slow) or LED (fast) mode  
Balancing of individual whites by Pixel  
Four intensity variation curves  
DMX IN/OUT on XLR 3/5-pin plug  
POWER IN/OUT with Powercon  
Power: AC 100 - 240V, 50/60Hz  
Power consumption: 180W  
Dimensions: 880 x 182 x 160 mm  
Weight: 9.33 kg



**BEAMBAR5-RGBW**  
LED Narrow Beam Bar, 5x 15W RGBW  
Osram + Artnet

Code : B04419 579€<sup>Incl. VAT</sup>



5 15W RGBW Osram LEDs  
Lens opening: 4.5°  
Frost filter: included  
DMX mode: 3-30 channels  
Ethernet input/output: Art-Net support  
Internal programs in standalone mode or via DMX, Master/slave mode, static or fade colours, static or sound-triggered chasers.  
Halogen (slow) or LED (fast) mode  
Balancing of individual whites by Pixel  
Four intensity variation curves  
DMX IN/OUT on XLR 3/5-pin plug  
POWER IN/OUT with Powercon  
Power: AC 100 - 240V, 50/60Hz  
Power consumption: 100W  
Dimensions: 440 x 182 x 160 mm  
Weight: 6.02 kg



**PIX9W44**  
16 9W TRI LED Flood Projector

Code : H10135 349€<sup>Incl. VAT</sup>



16 9W RGB LEDs  
Beam opening: 25°  
Digital display with drop-down menu for control  
DMX mode: 2-51 channels  
Fixed colours, Step or Fade programmes  
Auto mode, Audio mode with sound sensitivity, Slave mode  
Multi-slave mode to chain patterns across multiple devices  
DMX IN/OUT on XLR 3-pin plug  
POWER IN/OUT by IEC plug  
Power supply: AC 100/240V - 50/60Hz  
Power consumption: 200W  
temperature regulated ventilation  
Dimensions: 345 x 345 x 180 mm  
Net weight: 7.7 Kg

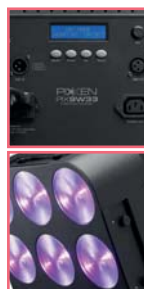

**PIX9W33**  
9 9W TRI LED Flood Projector

Code : H10133 249€<sup>Incl. VAT</sup>



9 9W RGB LEDs  
Beam opening: 25°  
Digital display with drop-down menu for control  
DMX mode: 2-30 channels  
Fixed colours, Step or Fade programmes  
Auto mode, Audio mode with sound sensitivity, Slave mode  
Multi-slave mode to chain patterns across multiple devices  
DMX IN/OUT on XLR 3-pin plug  
POWER IN/OUT by IEC plug  
Power supply: AC 100/240V - 50/60Hz  
Power consumption: 110W  
temperature regulated ventilation  
Dimensions: 260 x 260 x 180 mm  
Net weight: 4.9 Kg

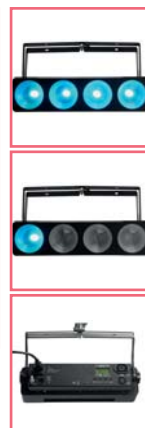

**PIX9W14**  
Bar with 4 9W TRI LEDs

Code : H10134 149€<sup>Incl. VAT</sup>



4 9W RGB LEDs  
Beam opening: 25°  
Digital display with drop-down menu for control  
DMX mode: 2-15 channels  
Fixed colours, Step or Fade programmes  
Auto mode, Audio mode with sound sensitivity, Slave mode  
Multi-slave mode to chain patterns across multiple devices  
DMX IN/OUT on XLR 3-pin plug  
POWER IN/OUT by IEC plug  
Power supply: AC 100/240V - 50/60Hz  
Power consumption: 48W  
temperature regulated ventilation  
Dimensions: 340 x 140 x 140 mm  
Net weight: 2.9 Kg



**BT-GLOWPANEL BRACKET**  
Hanger for BT-GLOWPANEL

Code : B04426 43.90€<sup>Incl. VAT</sup>



Suspension bracket for mounting BT-GLOWPANEL on a large-matrix structure.





### BT-GLOWPANEL

Matrix with 36 - 4° lenses with RGB (glow) effects

Code : B04425

789€<sup>Incl. VAT</sup>



36 3W 2800K LEDs 4° lens  
144 SMD 5050 LEDs for RGB (glow) effects  
LCD display: drop-down menu for control  
5 DMX modes: 4-48 channels  
Integral DMX control with different channel modes, from simple 4-channel mode to 48-channel mode for a complete RVB+dimmer control for each pixel and panel.  
Automatic mode, Slave mode  
DMX IN/OUT on XLR 3-pin plug  
POWER IN/OUT with Powercon  
Power supply: AC 100/240V - 50/60Hz  
Power consumption: 190W  
ventilation: natural convection  
Dimensions: 500 x 500 x 84 mm  
Net weight: 8.5 Kg  
Optional suspension bracket:  
BT-GLOWPANEL BRACKET



### BT-GLOWBAR BLACK

12 CREE 3W LEDs (2,800 K warm white), with 48 RVB 5050SMD LEDs for an RGB (glow) effect

Code : B05502

389€<sup>Incl. VAT</sup>



12 3W 2800K LEDs 4° lens  
48 SMD 5050 LEDs for RGB (glow) effects  
LCD display: drop-down menu for control  
6 DMX modes: 4-28 channels  
Integral DMX control with different channel modes, from simple 4-channel mode to 26/28-channel mode for a complete RVB+dimmer control for each pixel and panel.  
Automatic mode, Slave mode  
DMX IN/OUT on XLR 3/5-pin plug  
POWER IN/OUT with Powercon  
Power supply: AC 100/240V - 50/60Hz  
Power consumption: 70W  
ventilation: natural convection  
Dimensions: 100 x 83 x 109 mm  
Net weight: 5.1 Kg



### BT-GLOWBAR

With 12 CREE 3W LEDs and 48 RVB 5050SMD LEDs

Code : B04424

379€<sup>Incl. VAT</sup>



12 3W 2800K LEDs 4° lens  
48 SMD 5050 LEDs for RGB (glow) effects  
LCD display: drop-down menu for control  
6 DMX modes: 4-28 channels  
Integral DMX control with different channel modes, from simple 4-channel mode to 26/28-channel mode for a complete RVB+dimmer control for each pixel and panel.  
Automatic mode, Slave mode  
DMX IN/OUT on XLR 3/5-pin plug  
POWER IN/OUT with Powercon  
Power supply: AC 100/240V - 50/60Hz  
Power consumption: 70W  
ventilation: natural convection  
Dimensions: 100 x 83 x 109 mm  
Net weight: 5.1 Kg



### BT-GLOWPANEL BLACK

36 4° lens matrix with RGB effects

Code : B05503

799€<sup>Incl. VAT</sup>



36 3W 2800K LEDs 4° lens  
144 SMD 5050 LEDs for RGB (glow) effects  
LCD display: drop-down menu for control  
5 DMX modes: 4-48 channels  
Integral DMX control with different channel modes, from simple 4-channel mode to 48-channel mode for a complete RVB+dimmer control for each pixel and panel.  
Automatic mode, Slave mode  
DMX IN/OUT on XLR 3-pin plug  
POWER IN/OUT with Powercon  
Power supply: AC 100/240V - 50/60Hz  
Power consumption: 190W  
ventilation: natural convection  
Dimensions: 500 x 500 x 84 mm  
Net weight: 8.5 Kg  
Optional suspension bracket:  
BT-GLOWPANEL BRACKET



### CASE for 6x BT-GLOWPANEL

Flight case for 6x BT-GLOWPANEL

Code : B03269

379€<sup>Incl. VAT</sup>



### CASE for 8x BT-GLOWBAR

Flight case for 8x BT-GLOWBAR

Code : B03270

459€<sup>Incl. VAT</sup>

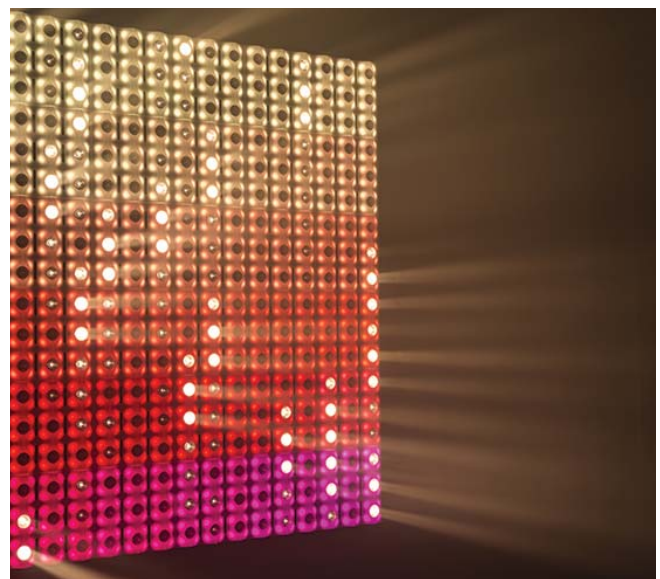

# PANELS, BLINDERS AND FLOOD

This attractive retro-style projector is perfect for many applications.

The combination of its golden reflector and an HPL-575 lamp creates a warm and pleasant light.

The high-power RGB LEDs can illuminate the reflector to produce incredible additional effects.

The BT-VINTAGE has an integrated DMX control to adjust the dimmer and RGB effects. It is prepared for TV studios with a flicker-free LED refresh rate.



## BT-VINTAGE

Retro-style projector with golden reflector, HPL-575 lamp and RGB LEDs to produce incredible warm colour effects.

Code : B04547

1239€incl. VAT



## CASE for 2x BT-VINTAGE

Flight case for 2x BT-VINTAGE

Code : B03271

689€incl. VAT



## HPL 575-X LL (code B02171)

230V halogen lamp for BT-VINTAGE. For a warm and pleasant light



RGB LEDs (156 x 1W RVB)  
Wireless DMX: USB port for WTR-DMX dongle (optional)  
PowerCON input and output  
XLR 3/5-pin input and output  
Power supply: AC 100/240V - 50/60Hz  
Power consumption: 980W  
Ventilation: natural convection  
Dimensions: 696 x 650 x 370 mm  
Net weight: 14 Kg

# MOVING HEADS

- Philips® MSD PLATINUM 15R lamp mounted
- 3-colour process with dichroic Cyan, magenta, yellow filters
- Motorised zoom x4
- Double gobo wheel
- Wheel with 6 additional colours
- 3-facet rotating prism and frost filter
- Iris

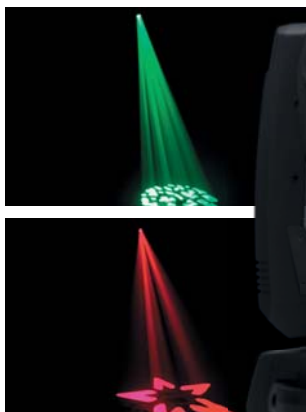

- OSRAM SIRIUS HRI 280 (7800 K°) lamp
- BEAM: from 2.6° to 11°
- SPOT: from 5.2° to 23°
- 1 wheel with 13 colours
- 14 fixed gobos + open
- 9 replaceable rotating gobos
- 8-facet prism + linear with 6 facets
- Frost | Zoom + Focus



**Evora-FLEX15R**  
Spot moving head with Philips® MSD PLATINUM 15R lamp

---

Code : H10295      3699€<sup>Incl. VAT</sup>



**FLY-Flex15Rx2**  
Flight case for 2 Evora-Beam/Flex15R

---



Code : H10343      699€<sup>Incl. VAT</sup>

**BTX-TITAN**  
BEAM + SPOT + WASH effects

---

Code : B04378      2599€<sup>Incl. VAT</sup>

**CASE FOR 2x BTX-TITAN**  
Flight case for 2x BTX-TITAN

---

Code : B03251      579€<sup>Incl. VAT</sup>



Philips® MSD PLATINIUM 15R source  
Opening: Variable zoom from 6 to 28°  
Light power: 38600 lux at 5m [6°]  
3-colour process with dichroic CMY filters  
Wheel with 6 dichroic colours  
Wheel with 8 rotating gobos  
Wheel with 14 fixed gobos  
3-facet rotating prism [16 Macros]  
Variable stroboscope and random strobe  
Variable iris from 5 to 100%  
Variable dimmer from 0 to 100%  
Variable frost from 0 to 100%  
Variable focus from 0 to 100%  
DMX mode: 21, 23 or 34 channels  
Drop-down menu display  
Amplitude: 540° or 630° pan - 270° tilt  
Power consumption: 400W  
Power supply: AC 100/230V - 50/60Hz  
Dimensions: 362x331x645 mm  
Net weight: 19 Kg

OSRAM SIRIUS HRI 280 source  
Beam from 2.6° to 11°: 82,650 lux at 20 m  
Spot from 5.2° to 23°: 25400 lux at 10 m  
2 combinable prisms:  
8-facet circular rotating prism  
6-facet linear rotating prism  
wheel with 9 rotating gobos + open  
wheel with 14 fixed gobos + open  
wheel with 13 dichroic colours (CTO-CTB)  
Frost effect (WASH)  
Stroboscopic effects  
Motorised Focus + Zoom  
Variable dimmer from 0 to 100%  
DMX mode: 16, 24 or 25 channels  
Drop-down menu display  
Amplitude: 540° pan - 270° tilt  
Power consumption: 400W  
Power supply: AC 100/230V - 50/60Hz  
Dimensions: 391x287x583 mm  
Net weight: 22 Kg



# MOVING HEADS



- 270W CW LED
- Linear zoom from 8 to 45°
- 3-facet prism
- Wheel with 7 rotating gobos + open
- Wheel with 9 colours including 2xCTO 1xCTB, UV + open
- Iris
- Frost
- Focus



- 3-in-1 beam, spot, wash moving head
- Powerful LED source
- 1 6-facet linear rotating prism
- 1 8-facet rotating circular prism
- Linear transition from Beam mode to Spot mode



**BTX-SATURN**  
Moving head with 270 W LED

Code : B04428      2990€<sup>Incl. VAT</sup>



**MOVING HEAD CASE 3**  
Flight case for 4x BTX-SATURN

Code : B03273      729€<sup>Incl. VAT</sup>



**FUSION180**  
Beam Spot and Wash moving head with 180W LED

Code : H10661      1899€<sup>Incl. VAT</sup>



**FLY2Fusion180**  
Flight case for 2x FUSION180

Code : H10737      699€<sup>Incl. VAT</sup>



270W CW LED source  
Linear zoom from 8 to 45°  
3-colour process with dichroic CMY filters  
3-facet circular rotating prism  
Wheel with 7 rotating gobos + open  
Wheel with 9 fixed gobos + 3 reducers  
Wheel with 9 colours including 2xCTO, 1xCTB, UV + open  
Variable iris  
Frost effect (WASH)  
Stroboscopic effects motorised focus  
Electronic dimmer variable from 0 to 100%  
DMX mode: 25 channels  
Drop-down menu display  
Amplitude: 540° pan - 270° tilt  
Power IN/OUT: Neutrik powerCON® TRUE-1  
DMX IN/OUT: XLR 3+5pin  
Power supply: AC 100/230V - 50/60Hz

180W CW LED source  
Linear zoom from 6 to 21° (Beam to Spot)  
Light power: 33000 lux at 5m (6°)  
8-facet circular rotating prism  
6-facet linear rotating prism  
wheel with 9 rotating gobos + open  
wheel with 12 fixed gobos + 3 reducers  
wheel with 10 dichroic colours + open  
Progressive Frost filter  
Wash function going from 34° to 60°  
Stroboscope from 1 to 25 flashes / second motorised focus  
Electronic dimmer variable from 0 to 100%  
DMX mode: 17,19 or 20 channels  
Drop-down menu display  
Amplitude: 540° or 630° pan - 270° tilt  
Power consumption: 305W  
Power supply: AC 100/230V - 50/60Hz  
Dimensions: 369x288x583 mm  
Net weight: 18 Kg

# FUSION180

La lyre hybride 3 en 1\*

\*3-in-1 hybrid moving head



by **Contest**



# MOVING HEADS



**BTX-BEAM 5R**  
Ultra powerful moving head based on the legendary Philips MSD Platinum 5R lamp!

Code : B04353      2019€<sup>Incl. VAT</sup>



Philips MSD Platinum 5R source  
Light power: 200000 lux at 10m  
Beam opening: 1 to 3.5°  
Stroboscopic effects  
Motorised focus  
Frost filter  
8-facet rotating prism wheel with 17 gobos + open wheel with 14 dichroic colours + open  
Variable dimmer from 0 to 100%  
DMX mode: 19 channels  
Drop-down menu display to assign and select different modes  
Amplitude: 540° pan - 270° tilt  
Power consumption: 290 W maximum  
Power supply: AC 100/230V - 50/60Hz  
Dimensions: 415 x 343 x 487 mm  
Net weight: 20 Kg



**SWORD5R**  
BEAM moving head with Philips® MSD PLATINUM 5R Lamp

Code : H10409      1299€<sup>Incl. VAT</sup>



Philips MSD Platinum 5R source  
Light power: 770000 lux at 5m  
Beam opening: 3.5°  
Strobe, pulse effect and random strobe  
Motorised focus  
Frost filter  
8-facet rotating prism wheel with 17 gobos + open wheel with 14 dichroic colours + open  
Variable dimmer from 0 to 100%  
DMX mode: 1, 12 and 16 channels  
Synchronised shows (internal microphone)  
Master / Slave mode  
Drop-down menu display to assign and select different modes  
Amplitude: 540° pan - 270° tilt  
Power consumption: 270 W maximum  
Power supply: AC 100/230V - 50/60Hz  
Dimensions: 500 x 394 x 525 mm  
Net weight: 18 Kg



**BTX-BEAM 2R**  
Ultra powerful moving head based on the legendary Philips MSD Platinum 2R lamp!

Code : B04372      1450€<sup>Incl. VAT</sup>



Philips MSD Platinum 2R source  
Light power: 338.400 lux at 5m  
Beam opening: 2.8°  
Motorised focus  
Stroboscopic effects  
8-facet rotating prism wheel with 17 gobos + open wheel with 14 dichroic colours + open  
Variable dimmer from 0 to 100%  
DMX mode: 14 and 16 channels  
Drop-down menu display to assign and select different modes  
Amplitude: 540° pan - 270° tilt  
Power consumption: 250 W  
Power supply: AC 100/230V - 50/60Hz  
Dimensions: 311 x 256 x 476 mm  
Net weight: 15 Kg



**CASE FOR 2x BTX-BEAM 5R**  
Flight case for 2 x BriteQ BTX-BEAM 5R

Code : B03239      379€<sup>Incl. VAT</sup>



**CASE FOR 4x BTX-BEAM 2R**  
Flight case for 4x BTX-BEAM 2R

Code : B03248      399€<sup>Incl. VAT</sup>





### RAY1R

Beam moving head with HRI 100W OSRAM® lamp

Code : H10410 859€<sup>Incl. VAT</sup>



### BT-TRACKER

Super compact but very powerful moving head SIRIUS HRI-100 lamp from OSRAM!

Code : B04387 859€<sup>Incl. VAT</sup>



### Thunder-80

Concentrated light beam moving head 80WLe

Code : H10176 699€<sup>Incl. VAT</sup>



Osram SIRIUS HRI 100W source  
Light power: 307200 lux at 5m  
Beam opening: 3°  
Strobe, pulse effect and random strobe  
8-facet rotating prism  
wheel with 15 gobos + open  
wheel with 14 dichroic colours + open  
Variable dimmer from 0 to 100%  
DMX mode: 1.10 and 14 channels  
Synchronised shows (internal microphone)  
Master / Slave mode  
Drop-down menu display to assign and select different modes  
Amplitude: 540° pan - 270° tilt  
Power consumption: 194.5 W maximum  
Power supply: AC 100/230V - 50/60Hz  
Dimensions: 279 x 225 x 387 mm  
Net weight: 9.2 Kg

Osram SIRIUS HRI 100W source  
Light power: 307200 lux at 5m  
Beam opening: 3°  
Strobe, pulse effect and random strobe  
8-facet rotating prism  
wheel with 10 gobos + 4 reducers + open  
wheel with 14 dichroic colours + open  
Variable dimmer from 0 to 100%  
DMX mode: 5 and 12 channels  
Synchronised shows (internal microphone)  
Master / Slave mode  
Drop-down menu display to assign and select different modes  
Amplitude: 540° pan - 270° tilt  
Power consumption: 194.5 W maximum  
Power supply: AC 100/230V - 50/60Hz  
Dimensions: 279 x 225 x 401 mm  
Net weight: 9.2 Kg

80W CW LED source  
Beam opening: 6°  
Strobe, pulse effect and random strobe  
3-facet rotating prism  
wheel with 7 rotating gobos + open  
wheel with 8 dichroic colours + open  
Electronic dimmer variable from 0 to 100%  
DMX mode: 1-11 channels  
Synchronised shows (internal microphone)  
Simplified control (EASY-2 compatible)  
Master / Slave mode  
Drop-down menu display to assign and select different modes  
Amplitude: 540° pan - 270° tilt  
Power consumption: 155W max.  
Power supply: AC 100/230V - 50/60Hz  
Dimensions: 292x185x461mm  
Net weight: 8 Kg



### FLY-RAY1R-HE-Z0120Zx4

Flight case for 4 RAY1R or 4 HEZ0120Z

Code : H10610 599€<sup>Incl. VAT</sup>



### CASE for 4x BT-TRACKER

Flight case for 4x BT-TRACKER.

Code : B03264 429€<sup>Incl. VAT</sup>



### FLY2CLUB-S1

Flight case for Typhoon/Thunder/Cyclone/Wave

Code : H10247 269€<sup>Incl. VAT</sup>



# MOVING HEADS



## BTX-HAWK

Very bright moving head controlled by a powerful 180 W LED module!

Code : B04398 1559€<sup>Incl. VAT</sup>



180W CW LED source  
motorised focus  
Beam opening: 12°  
3-facet rotating prism + linear prism wheel with 7 rotating gobos + open wheel with 9 fixed gobos + open wheel with 7 dichroic colours + open Frost filter  
Electronic dimmer variable from 0 to 100%  
DMX mode: 11 or 13 channels  
Synchronised shows (internal microphone)  
Master / Slave mode  
Drop-down menu display to assign and select different modes  
Wireless DMX: WTR-DMX dongle (optional)  
Power consumption: 230W  
Power supply: AC 100/230V - 50/60Hz  
Dimensions: 393x558x288 mm  
Net weight: 16.5 Kg



## Cyclone-120R

Spot moving head with 120 W LED and multi-effects

Code : H10402 829€<sup>Incl. VAT</sup>



120W CW LED source  
manual focus  
Beam opening: 15°  
Strobe, pulse effect and random strobe  
3-facet rotating prism wheel with 6 rotating gobos + open wheel with 8 dichroic colours + open Electronic dimmer variable from 0 to 100%  
DMX mode: 1-16 channels  
Synchronised shows (internal microphone)  
Simplified control (EASY-2 compatible)  
Master / Slave mode  
Drop-down menu display to assign and select different modes  
Amplitude: 540° pan - 270° tilt  
Power consumption: 200W max.  
Power supply: AC 100/230V - 50/60Hz  
Dimensions: 292x169x425mm  
Net weight: 8 Kg



## BT-METEOR

Compact and extremely bright LED moving head

Code : B04384 890€<sup>Incl. VAT</sup>



100W CW LED source  
motorised focus  
Beam opening: from 12° to 16°  
Strobe, pulse effect and random strobe  
3-facet rotating prism wheel with 6 rotating gobos + open wheel with 8 dichroic colours + open Electronic dimmer variable from 0 to 100%  
DMX mode: 5, 11 or 14 channels  
Synchronised shows (internal microphone)  
Master / Slave mode  
Drop-down menu display to assign and select different modes  
Wireless DMX: WTR-DMX dongle (optional)  
Power consumption: 160W  
Power supply: AC 100/230V - 50/60Hz  
Dimensions: 290x180x435mm  
Net weight: 8.75 Kg



## Cyclone-80

Spot moving head with 80W LED and multi-effects

Code : H10175 699€<sup>Incl. VAT</sup>



80W CW LED source  
manual focus  
Beam opening: 15°  
Strobe, pulse effect and random strobe  
3-facet rotating prism wheel with 7 gobos + open wheel with 8 dichroic colours + open Electronic dimmer variable from 0 to 100%  
DMX mode: 1-15 channels  
Synchronised shows (internal microphone)  
Simplified control (EASY-2 compatible)  
Master / Slave mode  
Drop-down menu display to assign and select different modes  
Amplitude: 540° pan - 270° tilt  
Power consumption: 150W max.  
Power supply: AC 100/230V - 50/60Hz  
Dimensions: 292x169x425mm  
Net weight: 8 Kg



## MOVING HEAD CASE 1

Flight case for 2x BT-METEOR, BT-70LS, BT-BEAM70

Code : B03255 219€<sup>Incl. VAT</sup>



## CASE for 2x BTX-HAWK

Flight case for 2x Briteq BTX-HAWK

Code : B03263 469€<sup>Incl. VAT</sup>







### Blast-60

Spot moving head with 60W LED

Code : H10312

579€<sup>Incl. VAT</sup>



### DYNASPOT

LED spot moving head with compact and bright 12° beam

Code : B04053

229€<sup>Incl. VAT</sup>



### CLUBSPOT

Compact moving head with 35W LED

Code : B05506

199€<sup>Incl. VAT</sup>

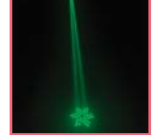

60W CW LED source  
Manual focus  
Beam opening from 14°  
Strobe, pulse effect and random strobe  
3-facet rotating prism  
Wheel with 6 rotating gobos + open  
Wheel with 8 dichroic colours + open  
Electronic dimmer variable from 0 to 100%  
DMX mode: 1, 8 or 12 channels  
Synchronised shows (internal microphone)  
Simplified control [EASY-2 compatible]  
Master / Slave mode  
Drop-down menu display to assign and select different modes  
Amplitude: 540° pan - 270° tilt  
Power consumption: 70 W maximum  
Power supply: AC 100/230V - 50/60Hz  
Dimensions: 212 x 174 x 352 mm  
Net weight: 5.3 Kg

10W CW LED source  
Manual focus  
Beam opening from 12°  
Stroboscopic effects  
Wheel with 6 fixed gobos + open  
Wheel with 8 dichroic colours + open  
Electronic dimmer variable from 0 to 100%  
DMX mode: 5, 8 or 10 channels  
Infrared remote control  
Synchronised shows (internal microphone)  
Master / Slave mode  
Wireless DMX: WTR-DMX dongle (optional)  
Drop-down menu display to assign and select different modes  
Amplitude: 540° pan - 270° tilt  
Power consumption: 70 W maximum  
Power supply: AC 100/230V - 50/60Hz  
Dimensions: 170 x 170 x 200 mm  
Net weight: 2.96 Kg

35W CW LED source  
Manual focus  
12° opening  
Stroboscopic effects  
Wheel with 7 fixed gobos + open  
Wheel with 7 dichroic colours + open  
Electronic dimmer variable from 0 to 100%  
DMX mode: 5, 9 or 11 channels  
Wireless DMX: WTR-DMX dongle (optional)  
Synchronised shows (internal microphone)  
Master / Slave mode  
Drop-down menu display to assign and select different modes  
Amplitude: 540° pan - 270° tilt  
DMX IN / OUT by XLR 3-pin plugs  
POWER IN / OUT by IEC plugs  
Power consumption: 60W maximum  
Power supply: AC 100/230V - 50/60Hz  
Dimensions: 284,5 x 205 x 149 mm  
Net weight: 3.5 Kg



### LIGHT EFFECT CASE 4

Flight case for 2x LYNX, 2x BT-20LS, 2x BT-30FC or 2x BT-W12L10 ZOOM

Code : B03225

169€<sup>Incl. VAT</sup>



### FLY4Hezo300ZR

Flight case for 4x HEZO300ZR

Code : H10736

649€<sup>Incl. VAT</sup>

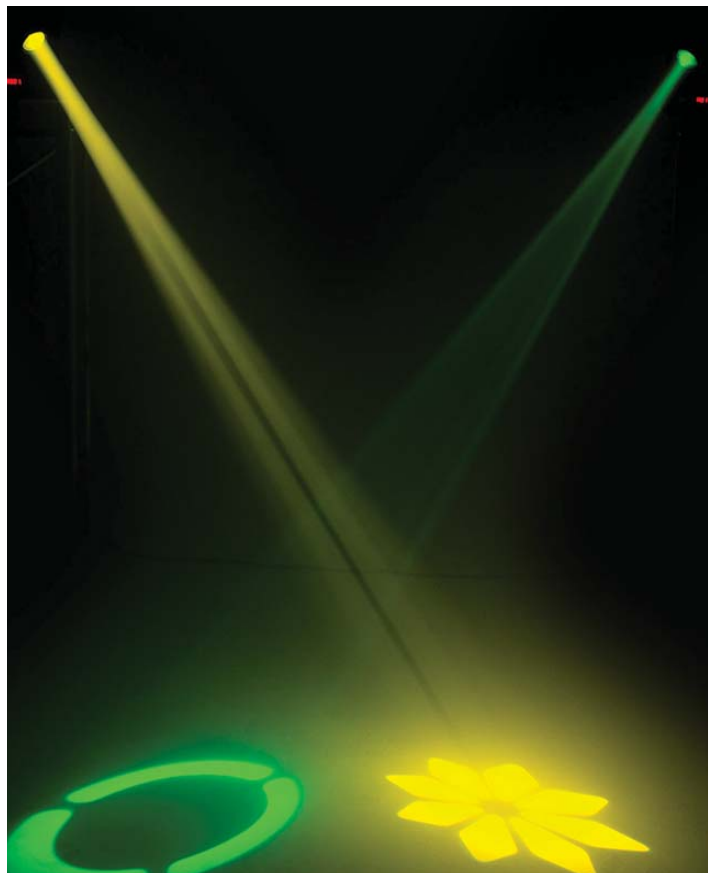

# MOVING HEADS



## HEZO300ZR

Moving head with 19 15W 4-in-1 RGBW LEDs with Zoom

Code : H10710

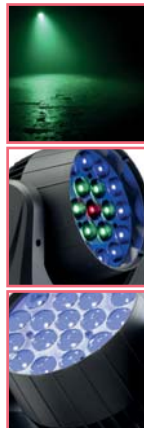

19 15W RGBW LED sources  
Opening from 10° to 60° by motorised lighted zoom: 9030 LUX at 5m at 10°  
Programmable white balance  
Colour preset, Colour macro Strobe, pulse effect and random strobe  
Electronic dimmer variable from 0 to 100%  
Motorised zoom from 10° to 60°  
Independent control of three colour zones (outer ring, inner ring and central point)  
DMX mode: 1, 22 or 30 channels  
Synchronised shows (internal microphone)  
Master / Slave mode  
Drop-down menu display to assign and select different modes  
Amplitude: 540° pan - 270° tilt  
DMX IN / OUT by XLR 3/5-pin plugs  
POWER IN / OUT by Powercon plugs  
Power consumption: 340W maximum  
Power supply: AC 100/230V - 50/60Hz  
Dimensions: 325 x 222 x 393 mm  
Net weight: 9 Kg



## BT-ORBIT

Big brother of the very popular BT-W19L10 ZOOM with output increased by 65%.

Code : B04423 1589€<sup>Incl. VAT</sup>



19 15W RGBW LED sources  
Opening from 10° to 60° by motorised lighted zoom: 8400 LUX at 5m at 10°  
Programmable white balance  
Colour preset, Colour macro Strobe, pulse effect and random strobe  
Electronic dimmer variable from 0 to 100%  
Wireless DMX: WTR-DMX dongle (optional)  
Independent control of three colour zones (outer ring, inner ring and central point)  
DMX mode: 14 or 27 channels  
Drop-down menu display to assign and select different modes  
Amplitude: 540° pan - 270° tilt  
DMX IN / OUT by XLR 3/5-pin plugs  
POWER IN / OUT by Powercon plugs  
Power consumption: 290W maximum  
Power supply: AC 100/230V - 50/60Hz  
Dimensions: 395 x 325 x 225 mm  
Net weight: 9 Kg



## BT-W19L10 ZOOM

Powerful and compact wash moving head

Code : B04359 1539€<sup>Incl. VAT</sup>



19 10W RGBW LED sources  
Opening from 10° to 60° by motorised lighted zoom: 5100 LUX at 5m at 10°  
Programmable white balance  
Colour preset, Colour macro Strobe, pulse effect and random strobe  
Electronic dimmer variable from 0 to 100%  
DMX mode: 14 channels  
Drop-down menu display to assign and select different modes  
Amplitude: 540° pan - 270° tilt  
DMX IN / OUT by XLR 3/5-pin plugs  
POWER IN / OUT by Powercon plugs  
Power consumption: 245W maximum  
Power supply: AC 100/230V - 50/60Hz  
Dimensions: 325 x 188 x 396 mm  
Net weight: 9.2 Kg



## HEZO120Z

Wash moving head 12 x 10 W RGBW OSRAM®

Code : H10408 1199€<sup>Incl. VAT</sup>



12 10W RGBW LED sources  
Opening from 10° to 60° by motorised lighted zoom: 2600 LUX at 5m at 10°  
Programmable white balance  
Colour preset, Colour macro Strobe, pulse effect and random strobe  
Electronic dimmer variable from 0 to 100%  
Motorised zoom from 10° to 60°  
DMX mode: 1-30 channels  
Synchronised shows (internal microphone)



## MOVING HEAD CASE 2

Flight case for 4 BT-Orbit / BT-W19 moving head

Code : B03272 529€<sup>Incl. VAT</sup>



Master / Slave mode  
Drop-down menu display to assign and select different modes  
Amplitude: 540° pan - 270° tilt  
DMX IN / OUT by XLR 3/5-pin plugs  
POWER IN/OUT with Powercon plugs  
Power consumption: 198W maximum  
Power supply: AC 100/230V - 50/60Hz  
Dimensions: 263 x 183 x 340 mm  
Net weight: 7.5 Kg



### NINJA7i

Moving head with 7 4-colour 15W LEDs

Code : H10405 999€<sup>Incl. VAT</sup>



7 15W RGBW LED sources  
Opening from 10° to 20°  
Light: 4400 LUX at 5m at 10°  
Colour preset, Colour macro Strobe, pulse effect and random strobe  
Electronic dimmer variable from 0 to 100%  
Independent control of two colour zones (outer ring and central point)  
DMX mode: 16-25 channels  
Synchronised shows (internal microphone)  
Master / Slave mode  
Drop-down menu display to assign and select different modes  
Amplitude: 540° or 630° pan - 270° tilt  
Infinite PAN and TILT rotation  
DMX IN / OUT by XLR 3-pin plugs POWER IN / OUT by Powercon plugs  
Power consumption: 130W maximum  
Power supply: AC 100/230V - 50/60Hz  
Dimensions: 319 x 226 x 243 mm  
Net weight: 5 Kg



### Ninja-7x15QC

Moving head with 7 4-colour 15W LEDs with diffuser filter and concentrator

Code : H10075 869€<sup>Incl. VAT</sup>



7 15W RGBW LED sources  
Source opening of 11° + Frost filter 20°  
Light: 4400 LUX at 5m at 10°  
Colour preset, Colour macro Strobe, pulse effect and random strobe  
Electronic dimmer variable from 0 to 100%  
Independent control of two colour zones (outer ring and central point)  
DMX mode: 15-21 channels  
Synchronised shows (internal microphone)  
Master / Slave mode  
Drop-down menu display to assign and select different modes  
Amplitude: 540° or 630° pan - 270° tilt  
DMX IN / OUT by XLR 3-pin plugs POWER IN / OUT by Powercon plugs  
Power consumption: 140W maximum  
Power supply: AC 100/230V - 50/60Hz  
Dimensions: 319 x 226 x 243 mm  
Net weight: 5.5 Kg



### BT-W07L12

Wash moving head 7 x 12W RGBW

Code : B04358 719€<sup>Incl. VAT</sup>



7 12W RGBW LED sources  
10° opening  
Independent control of four zones  
Light: 2300 LUX at 5m at 10°  
Colour preset, Colour macro Strobe, pulse effect and random strobe  
Electronic dimmer variable from 0 to 100%  
DMX mode: 1-28 channels  
Synchronised shows (internal microphone)  
Master / Slave mode  
Drop-down menu display to assign and select different modes  
Amplitude: 540° or 630° pan - 270° tilt  
DMX IN / OUT by XLR 3-pin plugs POWER IN / OUT by Powercon plugs  
Power consumption: 126W maximum  
Power supply: AC 100/230V - 50/60Hz  
Dimensions: 322 x 266 x 154 mm  
Net weight: 6.2 Kg



### BT-W36L3

Wash moving head 36 x 3W (12R-12G-12B)

Code : B04344 699€<sup>Incl. VAT</sup>



36 3W LED sources (12 Red + 12 Green + 12 Blue)  
12.5° opening  
Light: 5050 LUX at 5m at 12.5°  
Colour preset, Colour macro Strobe, pulse effect and random strobe  
Electronic dimmer variable from 0 to 100%  
DMX mode: 1-15 channels  
Synchronised shows (internal microphone)



### CASE FOR 4x BT-W36L3 / BT-W07L12

Flight case for 4x BT-W36L3 or BT-W07L12

Code : B03235 169€<sup>Incl. VAT</sup>



Master / Slave mode  
Drop-down menu display to assign and select different modes  
Amplitude: 540° or 630° pan - 270° tilt  
DMX IN / OUT by XLR 3-pin plugs POWER IN / OUT by Powercon plugs  
Power consumption: 150W maximum  
Power supply: AC 100/230V - 50/60Hz  
Dimensions: 267 x 167 x 282 mm  
Net weight: 5.8 Kg



### Fly4Ninja-S1

Flight case for 4 Ninja-7x15QC moving heads

Code : H10076 559€<sup>Incl. VAT</sup>



# MOVING HEADS



**TORNADO 7**  
Wash moving head 7 x 15W RGBW

Code : B04376      669€<sup>Incl. VAT</sup>



7 15W RGBW LED sources  
6° opening  
Light: 4400 LUX at 5m at 10°  
Colour preset, Colour macro Strobe, pulse effect and random strobe  
Electronic dimmer variable from 0 to 100%  
Independent control of four zones  
DMX mode: 17 and 34 channels  
Synchronised shows (internal microphone)  
Master / Slave mode  
Drop-down menu display to assign and select different modes  
Amplitude: 360° or 720° pan - 270° tilt  
Infinite PAN and TILT rotation  
DMX IN / OUT by XLR 3-pin plugs POW-ER IN by cord + 16A plug  
Power consumption: 170W maximum  
Power supply: AC 100/230V - 50/60Hz  
Dimensions: 296 x 224 x 224 mm  
Net weight: 4.7 Kg



**STRIKER**  
LED spot (10°-30W-white) and wash (6 x 8W RVBW) moving head

Code : B04190      449€<sup>Incl. VAT</sup>



Spot 30W CW LED sources  
Wash 6 8W RGBW LED sources  
Beam opening 10° (Spot)  
Motorised focus wheel with 7 fixed gobos + open wheel with 7 dichroic colours + open  
Electronic dimmer variable from 0 to 100%  
Stroboscopic effects  
DMX mode: 5 or 19 channels  
Wireless DMX: WTR-DMX dongle (optional)  
Synchronised shows (internal microphone)  
Master / Slave mode  
Drop-down menu display to assign and select different modes  
Amplitude: 540° pan - 270° tilt  
DMX IN / OUT with 3-pin plugs  
POWER IN by IEC plug + 16A plug  
Power consumption: 95W max.  
Power supply: AC 100/230V - 50/60Hz  
Dimensions: 150x230x330mm  
Net weight: 4.53 Kg



**BT-W30FC Mk2**  
Wash moving head 3 x 10W RGBW

Code : B04371      349€<sup>Incl. VAT</sup>



3 10W RGBW LED sources  
25° opening  
Strobe, pulse effect and random strobe  
Electronic dimmer variable from 0 to 100%  
DMX mode: 9 or 16 channels  
Synchronised shows (internal microphone)  
Master / Slave mode  
CA8 compatible (option)  
Drop-down menu display to assign and select different modes  
Amplitude: 540° pan - 270° tilt  
DMX IN / OUT by XLR 3-pin plugs POW-ER IN by IEC plug + 16A plug  
Power consumption: 57.4W maximum  
Power supply: AC 100/230V - 50/60Hz  
Dimensions: 272 x 231 x 248 mm  
Net weight: 6 Kg



**NEW**



**CLUBWASH**  
Wash moving head 7 x 12W RGBWAUV

Code : B05505      159€<sup>Incl. VAT</sup>



7 12W RGBWAUV LED sources  
25° opening  
Stroboscopic effects  
Electronic dimmer variable from 0 to 100%  
DMX mode: 5, 9 or 15 channels  
Wireless DMX: WTR-DMX dongle (optional)  
Synchronised shows (internal microphone)  
Master / Slave mode  
CA8 compatible (option)





**CASE for 4x STRIKER**  
Flight case for 4x STRIKER

Code : B03267      269€<sup>Incl. VAT</sup>

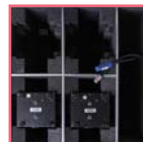

Drop-down menu display to assign and select different modes  
Amplitude: 160° pan - 90° tilt  
DMX IN / OUT by XLR 3-pin plugs POW-ER IN / OUT by PowerCON plugs  
Power consumption: 90W maximum  
Power supply: AC 100/230V - 50/60Hz  
Dimensions: 322.4 x 266.5 x 154 mm  
Net weight: 3 Kg



**CASE for 4x TORNADO 7**  
Flight case for 4x TORNADO 7

Code : B03247      229€<sup>Incl. VAT</sup>





### FLAG25i

Moving head with 5x5 15W RGBW LEDs

Code : H10406

2199€<sup>Incl. VAT</sup>



### BEAM WIZARD5x5

Moving head with 5x5 15W RGBW LEDs

Code : B04417

2199€<sup>Incl. VAT</sup>



### ROTOR7i

Motorised bar with 7 15W RGBW LEDs

Code : H10407

1099€<sup>Incl. VAT</sup>



25 15W RGBW (5 x 5) LED sources  
4° opening per lens  
Infinite PAN and TILT rotation  
Light: 29700 LUX at 5m  
Colour Preset and Macro  
Patterns: letters, digits and figures with customisable colours  
Automatic or musical programmes  
Strobe, pulse effect and random strobe  
Electronic dimmer variable from 0 to 100%  
DMX mode: 16, 21 and 117 channels  
Ethernet port: Art-NET/ KlingNET™  
Drop-down menu display to assign and select different modes  
Amplitude: 630° pan - 270° tilt  
DMX IN / OUT by XLR 3/5-pin plugs  
POWER IN / OUT by Powercon plugs  
Ethernet IN/OUT by RJ45  
Power consumption: 420W maximum  
Power supply: AC 100/230V - 50/60Hz  
Dimensions: 583 x 481 x 352 mm  
Net weight: 18.6 Kg

25 15W RGBW (5 x 5) LED sources  
4° opening per lens  
Infinite PAN and TILT rotation  
Light: 29700 LUX at 5m  
Colour Preset and Macro  
Patterns: letters, digits and figures with customisable colours  
Automatic or musical programmes  
Strobe, pulse effect and random strobe  
Electronic dimmer variable from 0 to 100%  
DMX mode: 12, 18, 110 and 116 channels  
Ethernet port: Art-NET  
Drop-down menu display to assign and select different modes  
Amplitude: 630° pan - 270° tilt  
DMX IN / OUT by XLR 3/5-pin plugs  
POWER IN / OUT by Powercon plugs  
Ethernet IN/OUT by RJ45  
Power consumption: 420W maximum  
Power supply: AC 100/230V - 50/60Hz  
Dimensions: 583 x 481 x 352 mm  
Net weight: 18.6 Kg

7 15W RGBW LED sources  
4° opening per lens  
Infinite PAN and TILT rotation  
Light: 8100 LUX at 5m  
Colour Preset and Macro  
Patterns: letters, digits and figures with customisable colours  
Automatic or musical programmes  
Strobe, pulse effect and random strobe  
Electronic dimmer variable from 0 to 100%  
DMX mode: 15, 20 and 44 channels  
Ethernet port: Art-NET/ KlingNET™  
Drop-down menu display to assign and select different modes  
Amplitude: 630° pan - 270° tilt  
DMX IN / OUT by XLR 3/5-pin plugs  
POWER IN / OUT by Powercon plugs  
Ethernet IN/OUT by RJ45  
Power consumption: 133W maximum  
Power supply: AC 100/230V - 50/60Hz  
Dimensions: 575 x 257 x 296 mm  
Net weight: 9.6 Kg



### FLY2FLAG25i

Flight case for 2 FLAG25i

Code : H10428

599€<sup>Incl. VAT</sup>



### FLY2ROTOR7i

Flight case for 2 ROTOR7i

Code : H10429

399€<sup>Incl. VAT</sup>



### CASE FOR BEAM WIZARD5x5

Flight case for 2x BT-BEAM WIZARD

Code : B03256

579€<sup>Incl. VAT</sup>



# MOVING HEADS



**DART90iZOOM**  
Moving head with 90W RGBW LED with zoom from 4° to 44° and continuous PAN and TILT movements

Code : H10594      749€<sup>Incl. VAT</sup>



90 W RGBW COB LED source  
Opening from 4° to 44° by motorised zoom  
Infinite PAN and TILT rotation  
Light: 3800 LUX at 5m at 4°  
Colour Preset and Macro  
Automatic or musical programmes  
Strobe, pulse effect and random strobe  
Electronic dimmer variable from 0 to 100%  
DMX mode: 13, 18 and 20 channels  
Ethernet port: Art-NET/ KlingNET™  
Drop-down menu display to assign and select different modes  
Amplitude: 540° or 630° pan - 270° tilt  
DMX IN / OUT by XLR 3-pin plugs POWER IN / OUT by Powercon plugs  
Ethernet IN/OUT by RJ45  
Power consumption: 120W maximum  
Power supply: AC 100/230V - 50/60Hz  
Dimensions: 304 x 236 x 186 mm  
Net weight: 5.2 Kg



**BEAM FURY-1**  
Moving head with 60W RGBW LED and continuous rotation

Code : B04394      649€<sup>Incl. VAT</sup>



60 W RGBW COB LED source  
4° opening [10° and 45° filters included]  
Infinite PAN and TILT rotation  
Light: 5280 LUX at 5m at 4°  
Colour Preset and Macro  
Automatic or musical programmes  
Strobe, pulse effect and random strobe  
Electronic dimmer variable from 0 to 100%  
DMX mode: 16 and 18 channels  
Drop-down menu display to assign and select different modes  
Amplitude: 540° or 630° pan - 270° tilt  
DMX IN / OUT by XLR 3/5-pin plugs  
POWER IN / OUT by Powercon plugs  
Power consumption: 80W maximum  
Power supply: AC 100/230V - 50/60Hz  
Dimensions: 304 x 236 x 186 mm  
Net weight: 5.3 Kg





**DART60i**  
Moving head with 60W RGBW LED and continuous rotation

Code : H10490      649€<sup>Incl. VAT</sup>

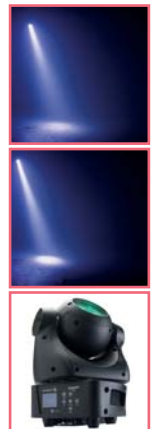

60 W RGBW COB LED source  
4° opening [10° and 45° filters included]  
Infinite PAN and TILT rotation  
Light: 5280 LUX at 5m at 4°  
Colour Preset and Macro  
Automatic or musical programmes  
Strobe, pulse effect and random strobe  
Electronic dimmer variable from 0 to 100%  
DMX mode: 16 and 18 channels  
Drop-down menu display to assign and select different modes  
Amplitude: 540° or 630° pan - 270° tilt  
DMX IN / OUT by XLR 3/5-pin plugs  
POWER IN / OUT by Powercon plugs  
Power consumption: 80W maximum  
Power supply: AC 100/230V - 50/60Hz  
Dimensions: 304 x 236 x 186 mm  
Net weight: 5.3 Kg



**CASE for 6x BEAM FURY-1**  
Flight case for 6x BEAM FURY-1

Code : B03265      399€<sup>Incl. VAT</sup>



**FLY-DARTx6**  
Flight case for 6 DART60i or DART60iZoom

Code : H10611      429€<sup>Incl. VAT</sup>



# SCANNERS



**VICTORYSCAN Mk2 LED**  
Scanner effect CREE 60 WATTS LED.

Code : B04054      369€<sup>Incl. VAT</sup>



60W CW LED source  
manual focus  
Beam opening: 17°  
wheel with 6 fixed gobos + open  
wheel with 8 dichroic colours + open  
Electronic dimmer variable from 0 to 100%  
DMX mode: 1, 7 or 8 channels  
Synchronised shows (internal microphone)  
Simplified control  
CA8 / RF-8SET compatible  
Master / Slave mode  
Drop-down menu display to assign and  
select different modes  
Power consumption: 105 W maximum  
Power supply: AC 100/230V - 50/60Hz  
Dimensions: 472 x 208 x 264 mm  
Net weight: 7.32 Kg





**DYNAMO 250**  
Attractive and compact scanner

Code : B04020      159€<sup>Incl. VAT</sup>



ELC250W/24V lamp source  
manual focus  
Beam opening: 13°  
Wheel with 10 multicolour gobos + open  
DMX mode: 4 channels  
Synchronised shows (internal microphone)  
Simplified control  
CA8 compatible  
Master / Slave mode  
Power supply: AC 100/230V - 50/60Hz  
Dimensions: 385 x 170 x 120 mm  
Net weight: 4.4 Kg





**DYNABARREL**  
LED effect with rotating mirror

Code : B04187      149€<sup>Incl. VAT</sup>



10W RGBW LED source  
manual focus  
DMX mode: 1 or 9 channels  
Synchronised shows (internal microphone)  
Simplified control: CA8 compatible  
Master / Slave mode  
DMX IN / OUT by XLR 3-pin plugs POW-  
ER IN / OUT by IEC plugs  
Power supply: AC 100/230V - 50/60Hz  
Dimensions: 331 x 170 x 120 mm  
Net weight: 2.95 Kg

**QUADROLL**  
Roller effect with 8W R/G/B/W LEDs

Code : H10290      269€<sup>Incl. VAT</sup>



4 R/G/B/W LED 8 W sources  
DMX mode: 1,3 and 10 channels  
Synchronised shows (internal microphone)  
Simplified control: EASY-2 compatible  
Master / Slave mode  
Drop-down menu display to assign and  
select different modes  
DMX IN / OUT by XLR 3-pin plugs POW-  
ER IN / OUT by IEC plugs  
Power consumption: 40 W maximum  
Power supply: AC 100/230V - 50/60Hz  
Dimensions: 479 x 247 x 132 mm  
Net weight: 2.2 Kg



**LIGHT EFFECT CASE 3**  
Flight case for 2x LED CLUBSCAN or 2x  
DYNAMO scan

Code : B03223      79€<sup>Incl. VAT</sup>

**LIGHT EFFECT CASE 7**  
For The Winner II, Led Victoryscan Led  
Spinner,...

Code : B03233      119€<sup>Incl. VAT</sup>



# MOVING HEAD COMPARISON

## Hybrid Beam/Spot/Wash moving heads

REF	NAME	Brand	Source	Auto Programme	CMY	Colour wheel	Rotating interchangeable gobos	Fixed gobos	Rotating circular prism
H10295	EVORA-Flex15R	Contest	15R 300W	yes	yes	6 colours	8 gobos	14 gobos	3 facets
B04378	BTX-TITAN	Briteq	HRI280 280W	no	no	13 colours (CTO + CTB)	9 gobos	14 gobos	combinable 8 facets
B04428	BTX-Saturn	Briteq	270W LED	no	yes	9 colours (CTO + CTB + UV)	7 gobos	9 gobos	3 facets
H10661	FUSION180	Contest	180W LED	yes	-	10 colours	9 gobos	15 gobos	8 facets

## Beam moving heads

REF	NAME	Brand	Source	Beam Opening	Auto Programme	PAN / TILT Macro	Colour wheel	Gobos	Rotating circular prism
B04353	BTX-BEAM 5R	Briteq	5R 189W	1° - 3.8°	no	yes	14 colours	17 gobos	8 facets
H10409	SWORD5R	Contest	5R 189W	3.5°	yes + sound	yes	14 colours	17 gobos	8 facets
B04372	BTX-BEAM 2R	Briteq	2R 132W	2.8°	no	yes	14 colours	17 gobos	8 facets
H10410	RAY1R	Contest	HRI-100 100W	3°	yes + sound	yes	14 colours	15 gobos	8 facets
B04387	BT-TRACKER	Briteq	HRI-100 100W	3°	sound	-	14 colours	15 gobos	8 facets
H10176	Thunder-80	Contest	80W LED	6°	yes + sound	yes	8 colours	7 rotating gobos	-

## Spot moving heads

REF	NAME	Brand	Source	Beam Opening	USB Port for B04645 WiFi dongle	Auto Programme	PAN / TILT Macro	Colour wheel	Rotating interchangeable gobos
B04398	BTX-HAWK	Briteq	180W LED	12°	yes	yes	-	7 colours	7 gobos
H10402	Cyclone120R	Contest	120W LED	15°	-	yes	yes	8 colours	6 gobos
B04384	BT-METEOR	Briteq	100W LED	12° to 16°	yes	yes	-	8 colours	6 gobos
H10175	Cyclone-80	Contest	80W LED	15°	-	yes	yes	8 colours	-
H10312	BLAST-60	Contest	60W LED	14°	-	yes	yes	8 colours	6 gobos
B05506	CLUBSPOT	JB Systems	35W LED	12°	yes	yes	-	7 colours	-
B04053	DYNASPOT	JB Systems	10W LED	12°	yes	yes + ir remote	-	7 colours	-

## Wash / Beam LED moving heads

REF	NAME	Brand	LED source	Beam Opening	Continuous Pan/Tilt rotation	USB Port for B04645 WiFi dongle	Auto Programme	PAN / TILT Macro	Colour wheel
H10710	HEZO300ZR	Contest	19x15W RGBW	10° to 60°	-	-	yes	yes	-
B04423	BT-ORBIT	Briteq	19x15W RGBW	10° to 60°	-	yes	-	-	-
B04359	BT-W19L10 ZOOM	Briteq	19x10W RGBW	10° to 60°	-	-	-	-	-
H10408	HEZO120Z	Contest	12x10W RGBW	10° to 60°	-	-	yes	yes	-
H10405	Ninja7i	Contest	7x15W RGBW	11°-20°	yes	-	yes	-	-
H10075	Ninja-7x15QC	Contest	7x15W RGBW	9°-11°-20°	-	-	yes	-	-
B04358	BT-W07L12	Briteq	7x12W RGBW	10°	-	-	yes	yes	-
B04344	BT-W36L3	Briteq	12xR-12xG-12xB 3W	12.5°	-	-	yes	yes	-
B04376	TORNADO 7	Briteq	7x15W RGBW	6°	yes	-	yes	-	-
B04371	BT-W30FC Mk2	Briteq	3x10W RGBW	25°	-	-	yes	yes	-
B05505	CLUBWASH	JB Systems	7x12W RGBWA+UV	25°	-	yes	yes	-	-
B04190	STRIKER	JB Systems	30W White 6x8W RGBW	10° spot	-	yes	yes	yes	7 colours

## LED effect moving heads

REF	NAME	Brand	LED source	Beam Opening	Continuous Pan/Tilt rotation	Art-NET compatibility	Auto Programme	Multi zones pixel	Motorised zoom
H10406	FLAG25i	Contest	25x15W QC	25x 4.5°	yes	yes RJ45 IN/OUT	yes	25	-
B04417	BEAM WIZARD5x5	Briteq	25x15W QC	25x 4.5°	yes	yes RJ45 IN/OUT	yes	25	-
H10407	ROTOR7i	Contest	7x15W QC	7x 4°	yes	yes RJ45 IN/OUT	yes	7	-
H10594	DART90i ZOOM	Contest	90W	4° to 44°	yes	yes RJ45 IN/OUT	yes	-	yes
B04394	BEAM FURY-1	Briteq	60W	4°-10°45°	yes	-	-	-	-
H10490	DART60i	Contest	60W	4°-10°45°	yes	-	yes	-	-



Linear rotating prism	Iris	Frost	Zoom Beam - Spot	Focus	Number of DMX channels	Battery for adjusting with power off	DMX XLR	Power supply	Weight	Flight case compatible
-	yes	Linear	6° to 28°	yes	21-23-34	yes	3 and 5 pin	Powercon IN	19Kg	H10343
combinable 6 facets	no	Linear	2.7° to 23°	yes	16-24-25	yes	3 and 5 pin	Powercon IN - OUT	22Kg	B03251
-	yes	Linear	8° to 45°	yes	25	no	3 and 5 pin	Powercon TRUE1 IN - OUT	22.7 kg	B03273
6 facets	-	Linear	6 to 21°	yes	17-19-20	yes	3 and 5 pin	Seetronic IN - OUT	18Kg	H10737

Trapezoidal rotating prism	Frost	Focus	Number of DMX channels	Battery for adjusting with power off	DMX XLR	Power supply	Weight	Flight case compatible
-	yes	yes	19	yes	3 and 5 pin	Powercon IN - OUT	20Kg	B03239
-	yes	yes	1-12-16	-	3 pin	Powercon IN - OUT	18Kg	B03239
yes	-	yes	14-16	-	3 and 5 pin	Powercon IN - OUT	15Kg	B03248
-	-	-	1-10-14	-	3 pin	Powercon IN - OUT	9.2Kg	H10610
-	-	-	5-12	-	3 pin	Powercon IN - OUT	9.7Kg	B03264
-	-	-	1-8-11	-	3 pin	IEC IN - OUT	8Kg	H10247

Fixed gobos	Rotating circular prism	Linear Prism	Frost	Focus	Number of DMX channels	Battery for adjusting with power off	DMX XLR	Power supply	Weight	Flight case compatible
9 gobos	3 facets	yes	yes	motorised	5-13-15	yes	3 and 5 pin	Powercon IN - OUT	15.5Kg	B03263
-	3 facets	-	-	manual	1-10-16	-	3 pin	IEC IN - OUT	8Kg	H10247
-	3 facets	-	-	motorised	5-11-14	-	3 pin	Powercon IN - OUT	8.75Kg	B03255
7 gobos	3 facets	-	-	manual	1-9-15	-	3 pin	IEC IN - OUT	8Kg	H10247
-	-	-	-	manual	1-8-12	-	3 pin	IEC IN - OUT	5.3Kg	H10247
7 gobos	-	-	-	manual	5-8-11	-	3 pin	IEC IN	3.5Kg	Coming soon
6 gobos	-	-	-	manual	5-8-10	-	3 pin	IEC IN - OUT	2.96Kg	-

Gobo Wheel	Multi zones pixel	Motorised Zoom / Focus	Number of DMX channels	Battery for adjusting with power off	DMX XLR	Power supply	Weight	Flight case compatible
-	3	Zoom	1-22-30	-	3 and 5 pin	Powercon IN - OUT	9Kg	H10736
-	3	Zoom	14a-14b-27	-	3 and 5 pin	Powercon IN - OUT	9.2Kg	B03272
-	-	Zoom	14a-14b	-	3 and 5 pin	Powercon IN - OUT	9.2Kg	B03272
-	-	Zoom	1-12-17	-	3 and 5 pin	Powercon IN - OUT	7.5Kg	H10610
-	2	-	16-20-25	yes	3 pin	Powercon IN - OUT	5.5Kg	H10076
-	2	-	15-17-21	yes	3 pin	Powercon IN - OUT	5.5Kg	H10076
-	4	-	1-4-9-12-16-28	-	3 pin	Powercon IN - OUT	6.4Kg	B03235
-	-	-	1-4-8-12-15	-	3 pin	Powercon IN - OUT	5.8Kg	B03235
-	4	-	17-34	-	3 pin	Power cable	4.7Kg	B03247
-	-	-	1-4-1-9-16	-	3 pin	IEC IN - OUT	4.2Kg	B03225
-	-	-	5-9-15	-	3 pin	IEC IN	3 kg	Coming soon
7 gobos	Spot / Wash	Focus	5-19	-	3 pin	IEC IN	4.5Kg	B03267

Number of DMX channels	Battery for adjusting with power off	DMX XLR	Power supply	Weight	Flight case compatible
16-21-117	yes	3 and 5 pin	Powercon IN - OUT	20Kg	H10428
12-18-110-116	yes	3 and 5 pin	Powercon IN - OUT	20Kg	B03256
15-20-44	yes	3 and 5 pin	Powercon IN - OUT	9.6Kg	H10429
13-18-20	yes	3 and 5 pin	Powercon IN - OUT	5.3Kg	H10611
12-14	yes	3 and 5 pin	Powercon IN - OUT	6.2Kg	B03265
12-17-19	yes	3 and 5 pin	Powercon IN - OUT	5.3Kg	H10611



# ANIMATION EFFECTS



## Heliptic-9x10WH

Animation projector with 3x3 white beams and continuous PAN

Code : H10311

849€<sup>Incl. VAT</sup>



## Heliptic-9x10QC

Animation projector with 3x3 4-colour beams and continuous PAN

Code : H10360

749€<sup>Incl. VAT</sup>



## Heliwave-8x10WH

Animation light bars with 2x4 white beams and continuous PAN

Code : H10293

799€<sup>Incl. VAT</sup>



9 10W White LED sources  
Beam opening 6° per lens  
Strobe, pulse effect and random strobe  
Electronic dimmer variable from 0 to 100%  
DMX mode: 1, 11, 16 and 15 channels  
Synchronised shows (internal microphone)  
Simplified control (EASY-2 compatible)  
Master / Slave mode  
Drop-down menu display to assign and select different modes  
Independent rotation of each bar  
Bar rotation over 145°  
Continuous PAN rotation  
DMX IN / OUT by XLR 3-pin plugs POWER IN / OUT by IEC plugs  
Power consumption: 106W max.  
Power supply: AC 100/230V - 50/60Hz  
Dimensions: 429 x 347 x 208 mm  
Net weight: 9.6 Kg

9 10W RGBW LED sources  
Beam opening 6° per lens  
Strobe, pulse effect and random strobe  
Electronic dimmer variable from 0 to 100%  
DMX mode: 1, 11, 43 and 47 channels  
Synchronised shows (internal microphone)  
Simplified control (EASY-2 compatible)  
Master / Slave mode  
Drop-down menu display to assign and select different modes  
Independent rotation of each bar  
Bar rotation over 145°  
Continuous PAN rotation  
DMX IN / OUT by XLR 3-pin plugs POWER IN / OUT by IEC plugs  
Power consumption: 126W max.  
Power supply: AC 100/230V - 50/60Hz  
Dimensions: 429 x 347 x 208 mm  
Net weight: 9.6 Kg

8 10W White LED sources  
Beam opening 6° per lens  
Strobe, pulse effect and random strobe  
Electronic dimmer variable from 0 to 100%  
DMX mode: 1, 10, 14 and 18 channels  
Synchronised shows (internal microphone)  
Simplified control (EASY-2 compatible)  
Master / Slave mode  
Drop-down menu display to assign and select different modes  
Independent rotation of each bar  
Bar rotation over 145°  
Continuous PAN rotation  
DMX IN / OUT by XLR 3-pin plugs POWER IN / OUT by IEC plugs  
Power consumption: 106W max.  
Power supply: AC 100/230V - 50/60Hz  
Dimensions: 393 x 232 x 239 mm  
Net weight: 9.6 Kg



## FLY-HELIWAVEx2

Flight case for 2 HELIWAVE

Code : H10340

299€<sup>Incl. VAT</sup>



## FLY-HELIPTIC

Flight case for 1 HELIPTIC

Code : H10341

249€<sup>Incl. VAT</sup>





### Storm-8x10QC

Moving head with double animation ramp.  
The madness of the colored multibeam

Code : H10172 629€<sup>Incl. VAT</sup>



### Storm-8x10WH

Moving head with double animation ramp.  
The madness of the white multibeam

Code : H10173 629€<sup>Incl. VAT</sup>



### Wave-8x10QC

Double motorized animation ramp. Colored  
multibeam effect.

Code : H10170 449€<sup>Incl. VAT</sup>

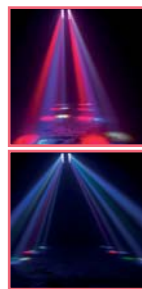

8 10W RGBW LED sources  
Beam opening 6° per lens  
Strobe, pulse effect and random strobe  
Electronic dimmer variable from 0 to 100%  
DMX mode: 1-37 channels  
Synchronised shows (internal microphone)  
Simplified control (EASY-2 compatible)  
Master / Slave mode  
Drop-down menu display to assign and  
select different modes  
Panoramic movement  
Independent rotation of each bar  
Amplitude: 540° pan - Bar rotation  
over 230°  
DMX IN / OUT by XLR 3-pin plugs POW-  
ER IN / OUT by IEC plugs  
Power consumption: 100W max.  
Power supply: AC 100/230V - 50/60Hz  
Dimensions: 414x153x376mm  
Net weight: 6.5 Kg

8 10W White LED sources  
Beam opening 6° per lens  
Strobe, pulse effect and random strobe  
Electronic dimmer variable from 0 to 100%  
DMX mode: 1-13 channels  
Synchronised shows (internal microphone)  
Simplified control (EASY-2 compatible)  
Master / Slave mode  
Drop-down menu display to assign and  
select different modes  
Panoramic movement  
Independent rotation of each bar  
Amplitude: 540° pan - Bar rotation  
over 230°  
DMX IN / OUT by XLR 3-pin plugs POW-  
ER IN / OUT by IEC plugs  
Power consumption: 100W max.  
Power supply: AC 100/230V - 50/60Hz  
Dimensions: 414x153x376mm  
Net weight: 6.5 Kg

8 10W RGBW LED sources  
Beam opening 6° per lens  
Strobe, pulse effect and random strobe  
Electronic dimmer variable from 0 to 100%  
DMX mode: 1-36 channels  
Synchronised shows (internal microphone)  
Simplified control (EASY-2 compatible)  
Master / Slave mode  
Drop-down menu display to assign and  
select different modes  
Independent rotation of each bar over 145°  
DMX IN / OUT by XLR 3-pin plugs POW-  
ER IN / OUT by IEC plugs  
Power consumption: 85W max.  
Power supply: AC 100/230V - 50/60Hz  
Dimensions: 395x234x180mm  
Net weight: 4.9 Kg



### Kadeo460QC

DMX projector with 4 60W 4-in-1 RGBW  
LEDs with zoom and effect

Code : H10652 599€<sup>Incl. VAT</sup>



### CASE for 2x BT-DAZZLE

Flight case for 2x BT-DAZZLE.

Code : B03258 229€<sup>Incl. VAT</sup>

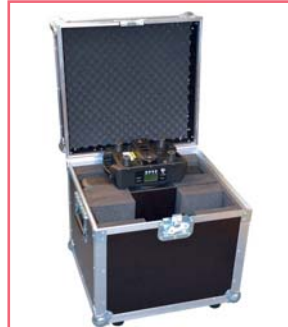

### FLY2CLUB-S2

Flight case for two Storm-8x10 moving  
heads

Code : H10248 269€<sup>Incl. VAT</sup>



4 60W RGBW LED sources  
Rotating lens: Indexable, infinity and  
variable shake  
Beam opening in Par mode from 6° to  
80° by motorised zoom  
RGBW setting and colour macros  
Electronic dimmer variable from 0 to 100%  
DMX mode: 1, 10 or 12 channels  
Synchronised shows (internal microphone)  
Simplified control (EASY-2 compatible)

Master / Slave mode  
Drop-down menu display to assign and  
select different modes  
Independent rotation of each bar over 145°  
DMX IN / OUT by XLR 3-pin plugs POW-  
ER IN by cord and 16A plugs  
Power consumption: 350W max.  
Power supply: AC 100/230V - 50/60Hz  
Dimensions: 342 x 320 x 305 mm  
Net weight: 6.3 Kg

# ANIMATION EFFECTS



## Firestorm-4x10WH

Bar with 4 10W white LED projectors with Pan and Tilt Movements

Code : H10291 599€<sup>Incl. VAT</sup>



## Firestorm-4x10QC

Bar with 4 10W RGBW LED projectors with Pan and Tilt Movements

Code : H10292 599€<sup>Incl. VAT</sup>



## FLY-FIRESTORMx2

Flight case for 2 FIRESTORM

Code : H10339 299€<sup>Incl. VAT</sup>



4 10W White LED sources  
 Beam opening 6° per lens  
 Strobe, pulse effect and random strobe  
 Electronic dimmer variable from 0 to 100%  
 DMX mode: 1, 11A, 11B and 15 channels  
 Synchronised shows (internal microphone)  
 Simplified control (EASY-2 compatible)  
 Master / Slave mode  
 Drop-down menu display to assign and select different modes  
 TILT movement of the bar  
 Independent PAN movement over 90° for each projector  
 DMX IN / OUT by XLR 3-pin plugs POWER IN / OUT by IEC plugs  
 Power consumption: 80W max.  
 Power supply: AC 100/230V - 50/60Hz  
 Dimensions: 791 x 152 x 232 mm  
 Net weight: 10.2 Kg

4 10W RGBW LED sources  
 Beam opening 6° per lens  
 Strobe, pulse effect and random strobe  
 Electronic dimmer variable from 0 to 100%  
 DMX mode: 1, 11, 23 and 27 channels  
 Synchronised shows (internal microphone)  
 Simplified control (EASY-2 compatible)  
 Master / Slave mode  
 Drop-down menu display to assign and select different modes  
 TILT movement of the bar  
 Independent PAN movement over 90° for each projector  
 DMX IN / OUT by XLR 3-pin plugs POWER IN / OUT by IEC plugs  
 Power consumption: 78W max.  
 Power supply: AC 100/230V - 50/60Hz  
 Dimensions: 791 x 232 x 152 mm  
 Net weight: 10.2 Kg



## RADIUS-515

Beam effect with 5 15W 4-in-1 RGBW LEDs

Code : H10667 329€<sup>Incl. VAT</sup>



## Swell-6x10WH

Rotating multibeam bar with 6 white 10 W LEDs

Code : H10260 299€<sup>Incl. VAT</sup>



5 15W RGBW LED sources  
 Beam opening 4° per lens  
 Automatic or musical programmes  
 DMX control: 1, 9, 12 or 28 channels  
 Drop-down menu display to assign and select different modes  
 Bar rotation over 240°  
 DMX IN / OUT by XLR 3-pin plugs POWER IN / OUT by IEC plugs  
 Power consumption: 80W max.  
 Power supply: AC 100/230V - 50/60Hz  
 Dimensions: 525 x 280 x 250 mm  
 Net weight: 5.870 kg

6 10W White LED sources  
 Beam opening 6° per lens  
 Strobe, pulse effect and random strobe  
 Electronic dimmer variable from 0 to 100%  
 DMX mode: 1-13 channels  
 Synchronised shows (internal microphone)  
 Simplified control (EASY-2 compatible)  
 Master / Slave mode  
 Drop-down menu display to assign and select different modes  
 Bar rotation over 240°  
 DMX IN / OUT by XLR 3-pin plugs POWER IN / OUT by IEC plugs  
 Power consumption: 64.5W max.  
 Power supply: AC 100/230V - 50/60Hz  
 Dimensions: 843 x 170 x 84 mm  
 Net weight: 4.9 Kg

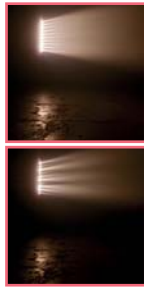

### SunBar103W

Bar with 10 warm white 3W LEDs with pixel control

Code : H10653 209€<sup>Incl. VAT</sup>



### FLY4Sunbar103

Flight case for 4x SUNBAR103W

Code : H10738 399€<sup>Incl. VAT</sup>



### SUPER LED RAINBOW

Powerful multibeam LED effects

Code : B04171 299€<sup>Incl. VAT</sup>



10 3W Warm White LED sources  
17 variable speed or sound-based pixel scrolling programmes  
Strobe, pulse effect and random strobe  
Electronic dimmer variable from 0 to 100%  
DMX mode: 1, 3, 5, 10 or 15 channels  
Synchronised shows (internal microphone)  
Simplified control (EASY-2 compatible)  
Master / Slave mode  
Drop-down menu display to assign and select different modes  
DMX IN / OUT by XLR 3-pin plugs POWER IN / OUT by Powercon plugs  
Power consumption: 36W max.  
Power supply: AC 100/230V - 50/60Hz  
Dimensions: 999 x 170 x 50 mm  
Net weight: 3.4 Kg

6 10W RGBW LED sources  
Beam opening 9° per lens  
Synchronised shows (internal microphone)  
Automatic or musical programmes  
Master / Slave mode  
DMX control: 1, 8 or 28 channels  
Simplified control (CA-8 compatible)  
Drop-down menu display to assign and select different modes  
DMX IN / OUT by XLR 3-pin plugs POWER IN / OUT by IEC plugs  
Power consumption: 80.6W max.  
Power supply: AC 100/230V - 50/60Hz  
Dimensions: 418 x 233 x 122 mm  
Net weight: 4.18 kg



### Beam-4x10QC

Multibeam coloured light bar 4x10W Compact multi-beam effect

Code : H10179 229€<sup>Incl. VAT</sup>



### Beam-4x10WH

Multibeam white light bar 4x10W Compact multibeam effect

Code : H10180 229€<sup>Incl. VAT</sup>



### FLASHBEAM

Double light bar with 8 9W TRI LEDs and 4 white Flash LEDs

Code : H10481 149€<sup>Incl. VAT</sup>



4 10W RGBW LED sources  
Beam opening 6° per lens  
Strobe, pulse effect and random strobe  
Electronic dimmer variable from 0 to 100%  
DMX mode: 1-18 channels  
Synchronised shows (internal microphone)  
Simplified control (EASY-2 compatible)  
Master / Slave mode  
Drop-down menu display to assign and select different modes  
DMX IN / OUT by XLR 3-pin plugs POWER IN / OUT by IEC plugs  
Power consumption: 45W max.  
Power supply: AC 100/230V - 50/60Hz  
Dimensions: 380x165x80mm  
Net weight: 2.7 Kg

4 10W White LED sources  
Beam opening 6° per lens  
Strobe, pulse effect and random strobe  
Electronic dimmer variable from 0 to 100%  
DMX mode: 1-6 channels  
Synchronised shows (internal microphone)  
Simplified control (EASY-2 compatible)  
Master / Slave mode  
Drop-down menu display to assign and select different modes  
DMX IN / OUT by XLR 3-pin plugs POWER IN / OUT by IEC plugs  
Power consumption: 45W max.  
Power supply: AC 100/230V - 50/60Hz  
Dimensions: 380x165x80mm  
Net weight: 2.7 Kg

8 9W RGB LED sources  
Beam opening 3° per lens + 4 White 1W LEDs (stroboscope)  
Pre-programmed shows, Colour control and stroboscopic LEDs  
Electronic dimmer variable from 0 to 100%  
Master / Slave mode  
DMX mode: 1, 4, 14 or 15 channels  
DMX IN / OUT by XLR 3-pin plugs POWER IN / OUT by IEC plugs  
Power consumption: 76W max.  
Power supply: AC 100/230V - 50/60Hz  
Dimensions: 605 x 184 x 268 mm  
Net weight: 3.2 kg



# ANIMATION EFFECTS



## SUPER QUADRA BEAM

Extremely dynamic scanning LED

Code : B04180 189€<sup>Incl. VAT</sup>



4 groups of 9 pcs 1W LEDs  
 (8 x red, 8 x green, 8 blue, 12 x white)  
 Synchronised shows (internal microphone)  
 Automatic or musical programmes  
 Master / Slave mode  
 DMX control: 1 or 3 channels  
 Simplified control (CA-8 compatible)  
 Drop-down menu display to assign and select different modes  
 DMX IN / OUT by XLR 3-pin plugs POWER IN / OUT by IEC plugs  
 Power consumption: 66 W max.  
 Power supply: AC 100/230V - 50/60Hz  
 Dimensions: 830 x 171 x 202 mm  
 Net weight: 5 kg



## SUPER ORION

Extremely dynamic scanning LED effect

Code : B04179 159€<sup>Incl. VAT</sup>



4 groups of 9 pcs 1W LEDs  
 (8 x red, 8 x green, 8 blue, 12 x white)  
 Synchronised shows (internal microphone)  
 Automatic or musical programmes  
 Master / Slave mode  
 DMX control: 1 or 3 channels  
 Simplified control (CA-8 compatible)  
 Drop-down menu display to assign and select different modes  
 DMX IN / OUT by XLR 3-pin plugs POWER IN / OUT by IEC plugs  
 Power consumption: 67 W max.  
 Power supply: AC 100/230V - 50/60Hz  
 Dimensions: 430 x 256 x 172 mm  
 Net weight: 4.1 kg



## ORION

LED effect

Code : B04143 159€<sup>Incl. VAT</sup>



4 groups with a total of 224 LEDs  
 (80 red, 60 green, 48 blue, 36 white)  
 Synchronised shows (internal microphone)  
 Automatic or musical programmes  
 Master / Slave mode  
 DMX control: 1, 4 and 7 channels  
 Simplified control (CA-8 compatible)  
 Drop-down menu display to assign and select different modes  
 DMX IN / OUT by XLR 3-pin plugs POWER IN / OUT by IEC plugs  
 Power consumption: 30 W max.  
 Power supply: AC 100/230V - 50/60Hz  
 Dimensions: 475 x 290 x 160 mm  
 Net weight: 5.3 kg



## ALIEN

LED effect + UV + stroboscope + laser

Code : B06200 239€<sup>Incl. VAT</sup>



3 projectors with 9 8 W RGB+UV LEDs  
 Effect with 84 0.75 W RGB+UV LEDs  
 Stroboscopic: 12 0.5 W white LEDs  
 Laser: red (100 mW) and green (30 mW)  
 laser motifs  
 IR remote control included  
 Synchronised shows (internal microphone)  
 Automatic or musical programmes  
 Master / Slave mode  
 DMX control: 3, 9, 11 or 28 channels  
 Drop-down menu display to assign and select different modes  
 DMX IN / OUT by XLR 3-pin plugs POWER IN / OUT by IEC plugs  
 Power consumption: 66 W max.  
 Power supply: AC 100/230V - 50/60Hz  
 Dimensions: 830 x 171 x 202 mm  
 Net weight: 5 kg



## BEAM TWISTER

Compact and innovative LED projector

Code : B04183 239€<sup>Incl. VAT</sup>



32W RGBW LED source  
 Synchronised shows (internal microphone)  
 Automatic or musical programmes  
 Master / Slave mode  
 DMX control: 1 or 4 channels  
 Simplified control (CA-8 compatible)  
 Drop-down menu display to assign and select different modes  
 DMX IN / OUT by XLR 3-pin plugs POWER IN / OUT by IEC plugs  
 Power consumption: 50W max.  
 Power supply: AC 100/230V - 50/60Hz  
 Dimensions: 350 x 352 x 203 mm  
 Net weight: 3.3 kg



## GOBOBEAM

Animation effect with 8 3W LEDs with projection of moving gobos

Code : H10662 199€<sup>Incl. VAT</sup>



8 3W RGB LED sources  
 Synchronised shows (internal microphone)  
 Automatic or musical programmes  
 Master / Slave mode  
 DMX control: 1, 8 or 12 channels  
 Simplified control (EASY-2 compatible)  
 Drop-down menu display to assign and select different modes  
 DMX IN / OUT by XLR 3-pin plugs POWER IN / OUT by IEC plugs  
 Power consumption: 40W max.  
 Power supply: AC 100/230V - 50/60Hz  
 Dimensions: 290 x 160 x 220 mm  
 Net weight: 3 kg



### LED-BLASTER

Animation effect Multibeam rotation  
2 RGBW 10W LEDs

Code : H9915

199€<sup>Incl. VAT</sup>



### DELirium

Animation effect Multibeam 320 RGBW  
LEDs

Code : H9893

189€<sup>Incl. VAT</sup>



### INVADER

Multieffect: 23W LED eff. + 200mW  
red+green laser

Code : B04176

199€<sup>Incl. VAT</sup>



2 10W RGBW LED sources  
Synchronised shows (internal microphone)  
Automatic or musical programmes  
Master / Slave mode  
DMX control: 1 or 3 channels  
Simplified control (EASY-2 compatible)  
Drop-down menu display to assign and select different modes  
DMX IN / OUT by XLR 3-pin plugs POWER IN / OUT by IEC plugs  
Power consumption: 34W max.  
Power supply: AC 100/230V - 50/60Hz  
Dimensions: 296 x 271 x 140 mm  
Net weight: 3.8 kg

320 LED sources (80 Red, 80 green, 80 blue, 80 white)  
Synchronised shows (internal microphone)  
Automatic or musical programmes  
Master / Slave mode  
DMX control: 4 channels  
Drop-down menu display to assign and select different modes  
DMX IN / OUT by XLR 3-pin plugs POWER IN / OUT by IEC plugs  
Power consumption: 40W max.  
Power supply: AC 100/230V - 50/60Hz  
Dimensions: 309 x 309 x 227 mm  
Net weight: 3.8 kg

Effect with 5 3 W RGBWA LEDs  
Stroboscopic: 8 1 W white LEDs  
Laser: red (150 mW) and green (50 mW) laser motifs  
Synchronised shows (internal microphone)  
Automatic or musical programmes  
Master / Slave mode  
DMX control: 1 or 9 channels  
Drop-down menu display to assign and select different modes  
DMX IN / OUT by XLR 3-pin plugs POWER IN / OUT by IEC plugs  
Power consumption: 66 W max.  
Power supply: AC 100/230V - 50/60Hz  
Dimensions: 240 x 220 x 110 mm  
Net weight: 3.75 kg



### LED-GUN

Multibeam animation effect with TRI  
10W LED

Code : H9541

169€<sup>Incl. VAT</sup>



### LED-BEAMER

Derby with 2 3-colour 9W LEDs

Code : H10023

89€<sup>Incl. VAT</sup>



### PARTY DERBY

Compact projector with 2 different led effects

Code : B04186

99€<sup>Incl. VAT</sup>

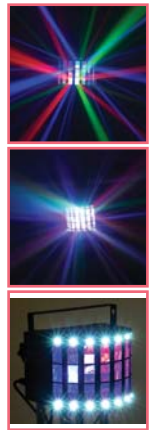

10W RGBW LED source  
Synchronised shows (internal microphone)  
Automatic or musical programmes  
Master / Slave mode  
DMX control: 3 channels  
Simplified control (EASY-2 compatible)  
Drop-down menu display to assign and select different modes  
DMX IN / OUT by XLR 3-pin plugs POWER IN / OUT by IEC plugs  
Power consumption: 12.5 W max.  
Power supply: AC 100/230V - 50/60Hz  
Dimensions: 271 x 176 x 213 mm  
Net weight: 3.0 kg

2 9W RGB LED sources  
Modes of operation:  
- Independent  
- Musical (internal microphone)  
Power consumption: 20W  
Power supply: AC 100/230V - 50/60Hz  
Dimensions: 310 x 205 x 310 mm  
Net weight: 3.4 kg

Derby LED effect  
Stroboscopic: 16 white LEDs  
IR remote control included  
Synchronised shows (internal microphone)  
Automatic or musical programmes  
Master / Slave mode  
DMX control: 1 or 5 channels  
Drop-down menu display to assign and select different modes  
DMX IN / OUT by XLR 3-pin plugs POWER IN / OUT by IEC plugs  
Power consumption: 28 W max.  
Power supply: AC 100/230V - 50/60Hz  
Dimensions: 190 x 258 x 182 mm  
Net weight: 1.72 kg

# ANIMATION EFFECTS

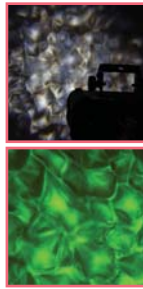

## LED AQUA

25W LED water simulator

Code : B04545 199€<sup>Incl. VAT</sup>



25W White LED source  
6 progressively changing colours  
The colour change can be blocked on 1 colour  
Adjustable focus  
Power consumption: 43.3W max.  
Power supply: AC 100/230V - 50/60Hz  
Dimensions: 255 x 245 x 196 mm  
Net weight: 3.4 kg



## LED VIRTUAL FLAME

Flame simulator 36cm diameter

Code : B04544 99€<sup>Incl. VAT</sup>



Equipped with 5 1W LED light emitting diodes  
The nearly silent fan allows a flame to be projected to a height of about 35 cm  
Place it on a flat surface or hang it with the set of fine mesh chains provided.  
Diameter of the fire cup: 36 cm  
Power consumption: 16.5W max.  
Power supply: AC 100/230V - 50/60Hz  
Net weight: 3.55 kg



## BEAMSPOT-4BAR NW

T-BAR with 4 BEAMSPOT NW 4500K

Code : B05508 409€<sup>Incl. VAT</sup>



4 white 15W 4500K LED sources  
4° opening [10° and 45° filters included]  
Electronic dimmer from 0 to 100%  
2 Mode dimmer: Slow, Fast  
4 Dimmer curves [LINEAR, SQUARE, INV.SQUARE, S-CURVE]  
DMX mode: 1, 2, 4 or 5 channels  
Wireless DMX: WTR-DMX dongle (optional)  
Drop-down menu display  
DMX IN / OUT by XLR 3/5-pin plugs  
POWER IN / OUT by PowerCON plugs  
Spigot support 28mm  
Power supply: AC 100/230V - 50/60Hz  
Dimensions: 552 x 85 x 315 mm  
Net weight: 6.74 Kg



## BEAMSPOT-4BAR WW

T-BAR with 4 BEAMSPOT WW 3200K

Code : B05507 409€<sup>Incl. VAT</sup>



4 15W Warm white 3200K LED sources  
4° opening per lens [10° and 45° filters included]  
Electronic dimmer variable from 0 to 100%  
2 Mode dimmer: Slow (halogen), Fast (LED)  
4 Dimmer curves [LINEAR, SQUARE, INV.SQUARE, S-CURVE]  
DMX mode: 1, 2, 4 or 5 channels  
Wireless DMX: WTR-DMX dongle (optional)  
Drop-down menu display to assign and select different modes  
DMX IN / OUT by XLR 3/5-pin plugs  
POWER IN / OUT by PowerCON plugs  
Spigot support 28mm  
Power consumption: 71W max.  
Power supply: AC 100/230V - 50/60Hz  
Dimensions: 552 x 85 x 315 mm  
Net weight: 6.74 Kg

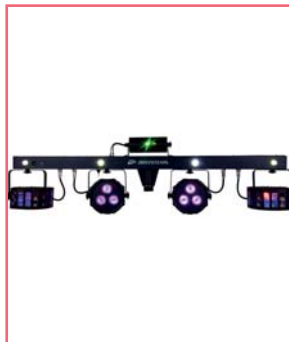

## PARTY BAR

The PARTY BAR is a fabulous set of 4-in-1 lights for mobile DJs!

Code : B04184 329€<sup>Incl. VAT</sup>



2 Derby effects equipped with a 3 W RGB LED  
2 projectors with 3 RGB 9 W LEDs  
4 cool white LEDs to create stroboscopic effects  
The bi-colour red/green laser  
IR remote control included  
Synchronised shows (internal microphone)  
Automatic or musical programmes  
Master / Slave mode  
DMX control: 3, 5, 6, 9 or 27 channels  
Wireless DMX: WTR-DMX dongle (optional)  
Drop-down menu display to assign and select different modes  
DMX IN / OUT by XLR 3-pin plugs POWER IN / OUT by IEC plugs  
Power consumption: 48 W max.  
Power supply: AC 100/230V - 50/60Hz  
Dimensions: 1185 x 386 x 110 mm  
Net weight: 8.35 kg



## PARTY BEAMS

This extremely compact bar is equipped with two different light effects to create superb light effects

Code : B04185 149€<sup>Incl. VAT</sup>



8 9W RGB LED sources  
Beam opening 7° per lens + 4 White 1W LEDs (stroboscope)  
Pre-programmed shows, Colour control and stroboscopic LEDs  
Electronic dimmer variable from 0 to 100%  
Master / Slave mode  
DMX mode: 3, 9 or 14 channels  
DMX IN / OUT by XLR 3-pin plugs POWER IN / OUT by IEC plugs  
Power consumption: 76W max.  
Power supply: AC 100/230V - 50/60Hz  
Dimensions: 605 x 184 x 268 mm  
Net weight: 3.2 kg







### SUPER BOOGIE

Double Led Flower DMX

Code : B04178 139€<sup>Incl. VAT</sup>



### SUPER ATLAS

Flower LED 9 x 1Watt

Code : B04177 79€<sup>Incl. VAT</sup>



### LED KAOS

Flower effect with 3 Watt LED

Code : B04175 69€<sup>Incl. VAT</sup>



Equipped with 2 sets of 9 1 Watt LEDs (4 x red, 4 x green, 4 blue, 6 x white)  
Synchronised shows (internal microphone)  
Automatic or musical programmes  
Master / Slave mode  
DMX control: 1 or 3 channels  
Simplified control (CA-8 compatible)  
Drop-down menu display to assign and select different modes  
DMX IN / OUT by XLR 3-pin plugs POWER IN / OUT by IEC plugs  
Power consumption: 35 W max.  
Power supply: AC 100/230V - 50/60Hz  
Dimensions: 246 x 230 x 164 mm  
Net weight: 2.6 kg

Equipped with 9 1 Watt LEDs (2 x red, 2 x green, 2 blue, 3 x white)  
Automatic programmes (internal microphone) Consumption: 20 W max.  
Power supply: AC 100/230V - 50/60Hz  
Dimensions: 141 x 224 x 203 mm  
Net weight: 1.4 kg

Flower effect equipped with one 3 Watt LED  
Plug & play  
3 operating modes: Static, automatic rotation, activated to the rhythm of the music.  
Double reflector  
Internal microphone  
External power supply transformer  
Consumption: 10 W max.  
Power supply: AC 100/230V - 50/60Hz  
Dimensions: 286 x 165 x 134 mm  
Net weight: 0.74 kg



### LED MOON

Rotating Flower Effect with extremely compact LED

Code : B04174 65€<sup>Incl. VAT</sup>



### LED DIAMOND

A DMX effect with very compact LED

Code : B04170 65€<sup>Incl. VAT</sup>



### LED DIAMOND II

A LED projector controlled by very attractive and compact DMX

Code : B04188 45.90€<sup>Incl. VAT</sup>



Rotating Flower effect equipped with one 3 Watt LED  
Plug & play  
3 operating modes: Static, automatic rotation, activated to the rhythm of the music.  
Double reflector  
Internal microphone  
External power supply transformer  
Consumption: 10 W max.  
Power supply: AC 100/230V - 50/60Hz  
Dimensions: 195 x 165 x 134 mm  
Net weight: 0.64 kg

6 3W LED sources (2 x red, 2 x green, 2 x blue)  
The 80 lenses project a full set of coloured rays covering a space of 360 degrees  
Synchronised shows (internal microphone)  
Automatic or musical programmes  
Master / Slave mode  
DMX control: 1 or 6 channels  
Drop-down menu display to assign and select different modes  
DMX IN / OUT with 3-pin plugs  
Power consumption: 35 W max.  
Power supply: AC 100/230V - 50/60Hz  
Dimensions: dia 183 x 157 mm  
Net weight: 1.07 kg

6 3W LED sources (1 red + 1 green + 1 blue + 1 white + 1 orange + 1 violet)  
The various lenses project many beams of clean colour over more than 360 degrees  
Synchronised shows (internal microphone)  
Automatic or musical programmes  
Master / Slave mode  
DMX control: 1 or 6 channels  
Drop-down menu display to assign and select different modes  
DMX IN / OUT with 3-pin plugs  
Power consumption: 24 W max.  
Power supply: AC 100/230V - 50/60Hz  
Dimensions: dia 190 x 175 mm  
Net weight: 0.42 kg

# ANIMATION EFFECTS



## NightBall

Half-sphere with 3 1W RGB LEDs With infrared remote control

Code : H10711 19€<sup>Incl. VAT</sup>



3 RGB 1W LEDs  
Automatic mode  
Sound mode  
Weight: 0.195 Kg  
Power consumption: 5W  
Dimensions: 125 x 105 x 120 mm  
AC 240V - 50Hz / 5 V DC adaptor supplied



## NightMotion

Mushroom type animation effect with 3 3W RGB LEDs With infrared remote control

Code : H10645 59€<sup>Incl. VAT</sup>



3 RGB 3W LEDs  
Automatic mode  
Sound mode  
Weight: 0.950 Kg  
Power consumption: 10W  
Dimensions: 180 x 160 x 190 mm  
AC 240V - 50Hz / 12 V DC adaptor supplied



## NightDerby

Derby type animation effect with 3 3W RGB LEDs With infrared remote control

Code : H10647 49€<sup>Incl. VAT</sup>



3 RGB 3W LEDs  
Automatic mode  
Sound mode  
Weight: 0.950 Kg  
Power consumption: 10W  
Dimensions: 180 x 160 x 200 mm  
AC 240V - 50Hz / 12 V DC adaptor supplied



## NightFlower

Flower type animation effect with 9W RGB LED With infrared remote control

Code : H10646 39€<sup>Incl. VAT</sup>



1 3-in-1 RGB 9W LED  
Automatic mode  
Sound mode  
Weight: 0.950 Kg  
Power consumption: 10W  
Dimensions: 180 x 160 x 190 mm  
AC 240V - 50Hz / 12 V DC adaptor supplied



## NightColor

Wash projector with 3 1W RGB LEDs With infrared remote control

Code : H10648 29€<sup>Incl. VAT</sup>



3x1W 1R 1G 1B LED  
Automatic mode  
Sound mode  
Weight: 0.55 Kg  
Power consumption: 5W  
Dimensions: 190 x 60 x 110 mm  
AC 240V - 50Hz / 12 V DC adaptor supplied



## LED MARVEL

LED Projector

Code : B04543 49€<sup>Incl. VAT</sup>



6 LED panels  
216 LEDs (72 red, 72 green, 72 blue)  
Static or sound-activated programmes (internal microphone)  
IR remote control included  
Control by DMX possible: 21 channels  
Weight: 0.6 Kg  
Power consumption: 12W  
Dimensions: 68 x 39 x 434 mm  
AC 240V - 50Hz / 12 V DC adaptor supplied



### NightFluo

Bar with 5 UV 1W LEDs and 4 Flash LEDs  
With infrared remote control

Code : H10649 35€<sup>Incl. VAT</sup>



5 UV LEDs  
4 Flash LEDs  
Automatic mode  
Sound mode  
Weight: 0.245 Kg  
Power consumption: 12W  
Dimensions: 530 x 40 x 60 mm  
AC 240V - 50Hz / 12 V DC adaptor supplied



### LED POLICE LIGHT BLUE

Blue LED rotating beacon

Code : B04540 25.90€<sup>Incl. VAT</sup>



Rotating beacon with 108 extremely brilliant LEDs  
Adjustable rotation speed  
Weight: 0.86 Kg  
Dimensions: dia 143 x 182 mm  
AC 240V - 50Hz / 12 V DC adaptor supplied



### LED POLICE LIGHT RED

Red LED rotating beacon

Code : B04541 25.90€<sup>Incl. VAT</sup>



Rotating beacon with 108 extremely brilliant LEDs  
Adjustable rotation speed  
Weight: 0.86 Kg  
Dimensions: dia 143 x 182 mm  
AC 240V - 50Hz / 12 V DC adaptor supplied



### LED SIXLIGHT

6-channel chaser with integrated microphone

Code : B04538 55.90€<sup>Incl. VAT</sup>



6 channel chaser  
Equipped with 282 LEDs (47 red, 47 green, 94 blue, 47 orange and 47 yellow)  
Modular: possibility of changing the shape of the device  
Integrated microphone  
Adjustable speed and audio sensitivity  
Weight: 2.1 Kg  
Dimensions: 365 x 347 x 182 mm  
AC 240V - 50Hz / 14 V DC adaptor supplied



# LASERS



## BT-LASER1500 RGB

1.5 W - R:500 mW - G:200 mW - B:800 mW

Code : B04235      1049€<sup>Incl. VAT</sup>



Superb 1.5Watt Class IV laser  
Incorporates 3 powerful coloured lasers (RVB):  
Red laser 500 mW (638 nm)  
Green laser 200 mW (532 nm)  
Blue laser 800 mW (450 nm)  
20Kpps scanners for clean, flawless RGB images!  
100% ILDA compatible for maximum flexibility in use!  
SD card reader to project your own motifs and logos.  
6 user modes  
CONTROLLED BY THE MUSIC  
MASTER/SLAVE  
AUTOMATIC  
DMX mode: 1 or 13 channels  
ILDA mode  
SD CARD mode  
Power consumption: 45W max.  
Power supply: AC 100/230V - 50/60Hz  
Dimensions: 300 x 240 x 160 mm  
Net weight: 7.8 kg  
Meets EN/IEC 60825-1 Ed2, 2007-03 safety standards with respect to lasers

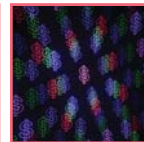

## SPECTRA-3D Laser

480 mW - R:100 mW - G:80 mW - B:300 mW

Code : B04230      599€<sup>Incl. VAT</sup>



RGB Class III 480mW laser  
Incorporates 3 powerful coloured lasers (RGB):  
Red laser 100 mW (638 nm)  
Green laser 80 mW (532 nm)  
Blue laser 300 mW (450 nm)  
25Kpps scanners combined with 4 effect wheels, Motifs and 3D effect shows, 80 motifs and RGB beams, burst effects... ILDA compatible for maximum use flexibility!  
User modes:  
MASTER/SLAVE  
STANDALONE: automatic and sound  
DMX mode: 1, 2 or 19 channels  
ILDA mode  
Power consumption: 40W max.  
Power supply: AC 100/230V - 50/60Hz  
Dimensions: 290 x 240 x 110 mm  
Net weight: 4.16 kg  
Meets EN/IEC 60825-1 Ed2, 2007-03 safety standards with respect to lasers



## MULTIBEAM LASER

850 mW - 2xR: 150 mW - G: 50 mW - B: 500 mW

Code : B04236      339€<sup>Incl. VAT</sup>



RGRB White Class 3B 850 mW laser equipped with 4 powerful temperature controlled lasers:  
2 150 mW red lasers (650 nm)  
1 50 mW green laser (532 nm)  
1 500 mW blue laser (450 nm)  
4 user modes:  
Musical mode: 100% plug&play  
MASTER/SLAVE mode  
AUTOMATIC mode  
DMX mode: 2 or 10 channels  
Infrared remote control included  
LED display to facilitate navigation in the configuration menu  
Power consumption: 65W max.  
Power supply: AC 100/230V - 50/60Hz  
Dimensions: 537 x 268 x 170 mm  
Net weight: 5 kg  
Meets EN/IEC 60825-1 Ed2, 2007-03 safety standards with respect to lasers



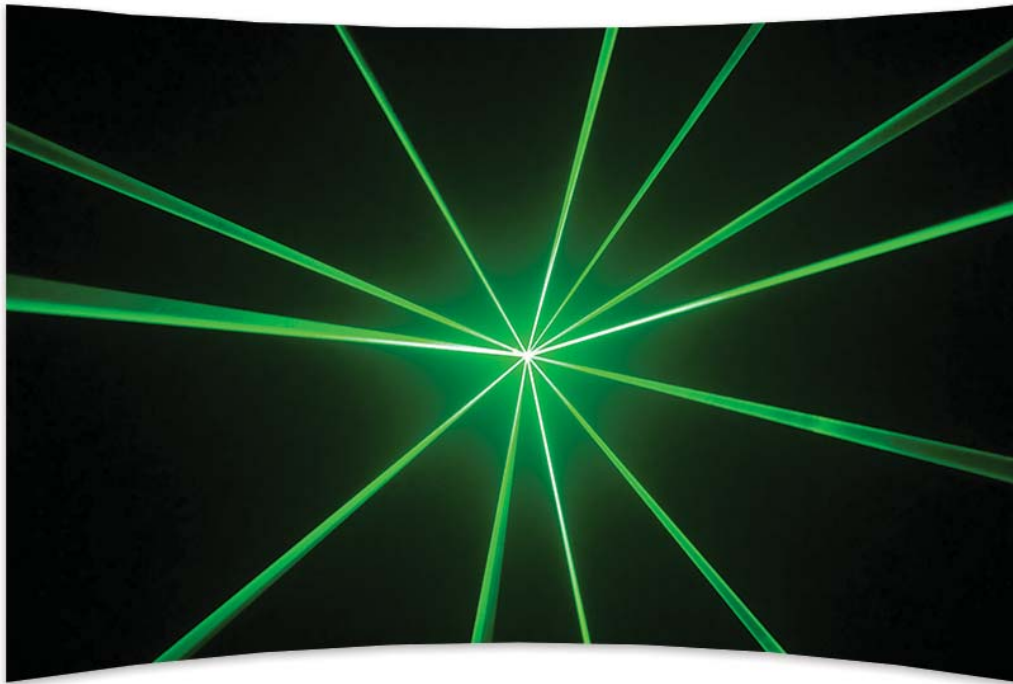

### SPACE-4 Laser

G: 40mW

Code : B04232

109€<sup>Incl. VAT</sup>

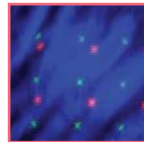

### LOUNGE LASER DMX

190 mW R: 150 mW -G: 40 mW

Code : B04221

159€<sup>Incl. VAT</sup>

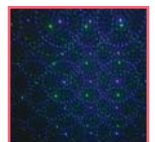

### μ-PHOTON Laser

120 mW - G: 40 mW - B: 80 mW

Code : B04229

119€<sup>Incl. VAT</sup>



Green 40mW Class 3B compact laser  
Several modes are available:  
DMX mode: 1 or 8 channels  
Standalone mode: sound activated (via internal microphone) or automatic mode  
Infrared remote control included  
Master/Slave mode  
3-digit LED display for simple navigation of the menus  
Power consumption: 12W max.  
Power supply: AC 100/230V - 50/60Hz  
Dimensions: 145 x 160 x 80 mm  
Net weight: 1.48 kg  
Meets EN/IEC 60825-1 Ed2, 2007-03 safety standards with respect to lasers

190mW laser with one green 40mW laser and one 150mW red laser + blue LED projector with waterwave style!  
Several modes are available:  
DMX mode: 1 or 7 channels  
Standalone mode: sound activated (via internal microphone) or automatic mode  
Master/Slave mode  
3-digit LED display for simple navigation of the menus  
Power consumption: 15W max.  
Power supply: AC 100/230V - 50/60Hz  
Dimensions: 233 x 165 x 200 mm  
Net weight: 1.9 kg  
Meets EN/IEC 60825-1 Ed2, 2007-03 safety standards with respect to lasers

Laser using a green 40mW 532nm laser and a blue 80mW 450nm laser  
Plug-and-Play: no controller necessary!  
Infrared remote control included  
Standalone mode with integrated microphone or automatic shows mode.  
Stroboscopic effect available  
Adjustable support and AC adaptor included.  
Power consumption: 5.7 W max.  
Power supply: AC 100/230V - 50/60Hz  
Dimensions: 117 x 92 x 46 mm  
Net weight: 0.64 kg  
Complies with EN/IEC 60825-1 Ed2, 2007-03 standards concerning Laser Safety

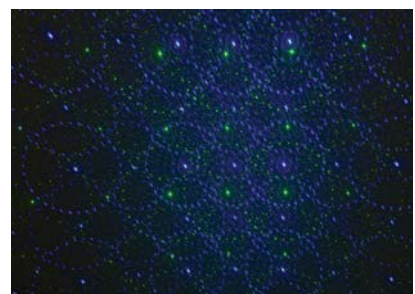

# LASERS



## RADIANT LASER

240 mW - G: 40 mW - B: 200 mW

Code : B04222 369€<sup>Incl. VAT</sup>



## SMOOTH SCAN-BLUE Laser

G: 400 mW

Code : B04227 295€<sup>Incl. VAT</sup>



## SMOOTH SCAN-3 Laser

140 mW - G: 100 mW - V: 40 mW

Code : B04226 209€<sup>Incl. VAT</sup>



## LASER INTERLOCK SWITCH

Emergency stop mushroom button for Laser

Code : B04210 24.90€<sup>Incl. VAT</sup>



Class 3B Laser with one green 40mW 532nm laser and one blue 200mW 450nm laser.  
Several modes are available:  
DMX mode: 1 or 10 channels  
Standalone mode: sound activated (via internal microphone) or automatic mode  
Master/Slave mode  
Simplified control (CA-8 compatible)  
Compatible with RF-DMX Converter:  
3-character LED screen for easy navigation through the menus.  
Power consumption: 30W max.  
Power supply: AC 100/230V - 50/60Hz  
Dimensions: 250 x 240 x 190 mm  
Net weight: 2.92 kg  
Meets EN/IEC 60825-1 Ed2, 2007-03 safety standards with respect to lasers

Class 3B Laser based on one blue 400mW 450nm laser.  
Fluid movements, 80 motifs, numbers, designs, words, etc....  
Several modes are available:  
DMX mode: 1 or 17 channels  
Standalone mode: sound activated (via internal microphone) or automatic mode  
Infrared remote control included  
Master/Slave mode  
3-digit LED display for simple navigation of the menus  
Power consumption: 13W max.  
Power supply: AC 100/230V - 50/60Hz  
Dimensions: 190 x 170 x 80 mm  
Net weight: 1.61 kg  
Meets EN/IEC 60825-1 Ed2, 2007-03 safety standards with respect to lasers

Class 3B Laser based on one green 40mW 532nm laser and one red 100mW 650nm laser.  
Fluid movements, 80 motifs, numbers, designs, words, etc....  
Several modes are available:  
DMX mode: 1 or 17 channels  
Standalone mode: sound activated (via internal microphone) or automatic mode  
Infrared remote control included  
Master/Slave mode  
3-digit LED display for simple navigation of the menus  
Power consumption: 13W max.  
Power supply: AC 100/230V - 50/60Hz  
Dimensions: 190 x 170 x 80 mm  
Net weight: 1.61 kg  
Meets EN/IEC 60825-1 Ed2, 2007-03 safety standards with respect to lasers

This emergency switch is additional safety for your laser projector.





### μ-QUANTUM Laser

180 mW - R: 100 mW - B: 80 mW

Code : B04228 101,90€<sup>Incl. VAT</sup>

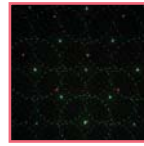

### μ-QUASAR Laser

140 mW - G: 40 mW - R: 100 mW

Code : B04225 82,90€<sup>Incl. VAT</sup>



### μ-STAR Laser

140 mW - G: 40 mW - R: 100 mW

Code : B04224 69€<sup>Incl. VAT</sup>



Laser using one red 100mW 650nm laser and one blue 80mW 450nm laser  
 Plug-and-Play: no controller necessary!  
 Infrared remote control included  
 Standalone mode with integrated microphone or automatic shows mode.  
 Stroboscopic effect available  
 Adjustable support and AC adaptor included.  
 Power consumption: 5.7 W max.  
 Power supply: AC 100/230V - 50/60Hz  
 Dimensions: 117 x 92 x 46 mm  
 Net weight: 0.64 kg  
 Complies with EN/IEC 60825-1 Ed2, 2007-03 standards concerning Laser Safety

Laser using one red 100mW 650nm laser and one green 40mW 532nm laser  
 Plug-and-Play: no controller necessary!  
 Infrared remote control included  
 Standalone mode with integrated microphone or automatic shows mode.  
 Stroboscopic effect available  
 Adjustable support and AC adaptor included.  
 Power consumption: 5.7 W max.  
 Power supply: AC 100/230V - 50/60Hz  
 Dimensions: 117 x 92 x 46 mm  
 Net weight: 0.64 kg  
 Complies with EN/IEC 60825-1 Ed2, 2007-03 standards concerning Laser Safety

Laser using one red 100mW 650nm laser and one green 40mW 532nm laser  
 Plug-and-Play: no controller necessary!  
 Infrared remote control included  
 Standalone mode with integrated microphone or automatic shows mode.  
 Stroboscopic effect available  
 Adjustable support and AC adaptor included.  
 Power consumption: 5.7 W max.  
 Power supply: AC 100/230V - 50/60Hz  
 Dimensions: 117 x 92 x 46 mm  
 Net weight: 0.64 kg  
 Complies with EN/IEC 60825-1 Ed2, 2007-03 standards concerning Laser Safety

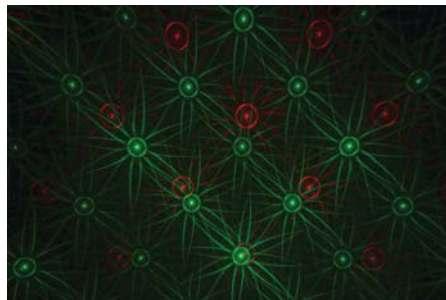
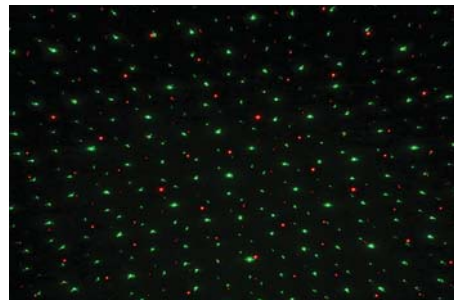
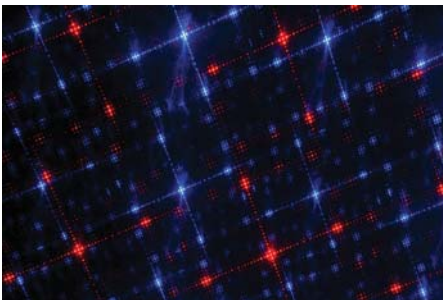

# STROBES



## BT-GIGAFLASH RGB

Colour LED strobe with 3 separately controllable segments and 1260 RGB strobe LEDs

Code : B04716 999€ incl. VAT



## BT-GIGAFLASH

Strobe LED with 9 separately controllable segments and a light output of +/- 100 000 lm.

Code : B04714 799€ incl. VAT



## BT-MAGICFLASH RGB

Colour LED strobe with 3 separately controllable segments and 324 RGB strobe LEDs

Code : B04717 399€ incl. VAT



1260 RGB LEDs source  
3 independent sections frequency from 0 to 30 Hz and Blinder mode  
Flicker free  
7 different DMX modes with 1 to 13 channels  
LCD display with drop-down menu  
Reflector shutters for more rendering  
DMX 3 and 5 XLR  
Powercon In and Out  
Forced and regulated ventilation  
Power supply: 240V/50Hz 800 W max  
Dimensions: 471 x 195 x 274 mm  
Weight: 8.5 kg

1260 4500°K LEDs source  
9 independent sections frequency from 0 to 30 Hz and Blinder mode  
Flicker free  
7 different DMX modes with 1 to 13 channels  
LCD display with drop-down menu  
Reflector shutters for more rendering  
DMX 3 and 5 XLR  
Powercon In and Out  
Forced and regulated ventilation  
Power supply: 240V/50Hz 900 W max  
Dimensions: 471 x 195 x 274 mm  
Weight: 8.5 kg

324 RGB LEDs source  
3 independent sections frequency from 0 to 30 Hz and Blinder mode  
Flicker free  
7 different DMX modes with 1 to 13 channels  
LCD display with drop-down menu  
DMX XLR 3  
Powercon In and Out  
Forced and regulated ventilation  
Power supply: 240V/50Hz 140 W max  
Dimensions: 336 x 126 x 212 mm  
Weight: 4.0 kg



## BT-MAGICFLASH

Powerful LED strobe with 9 separately controllable segments and a light output of +/- 35,000 lm.

Code : B04715 349€ incl. VAT



## BT-STROBE3000

Powerful professional strobe with outstanding brightness.

Code : B04711 279€ incl. VAT



## BT-STROBE 1500

A powerful 1,500 W professional strobe, 2 DMX channels with intense light output.

Code : B04713 159€ incl. VAT



324 4500°K LEDs source  
9 independent sections frequency from 0 to 30 Hz and Blinder mode  
Flicker free  
7 different DMX modes with 1 to 13 channels  
LCD display with drop-down menu  
DMX XLR 3  
Powercon In and Out  
Forced and regulated ventilation  
Power supply: 240V/50Hz 250 W max  
Dimensions: 336 x 126 x 212 mm  
Weight: 4.0 kg

PX-3000 Xenon lamp source  
Variable frequency and effects  
4 different DMX modes with 1 to 4 channels  
Drop-down menu LED display  
DMX 3 and 5 XLR  
Power supply: 240V/50Hz 250 W max  
Dimensions: 486 x 154 x 255 mm  
Weight: 6.8 kg

1500W Xenon lamp source  
Variable frequency and effects  
Adjustment of speed and dimmer by potentiometer  
2 DMX channels (speed and dimmer)  
DMX XLR 3  
Input Jack for CA-8 controller  
Power supply: 240V/50Hz  
Dimensions: 458 x 147 x 116 mm  
Weight: 3.58 kg





### STB-520

1500 W active sound strobe and DMX

Code : H7122

159€ incl. VAT



Xenon XOP15 1500 W lamp source  
 Variable frequency and audio mode  
 Adjustment of speed and dimmer by dip switches  
 2 DMX channels (speed and dimmer)  
 DMX XLR 3  
 Power supply: 240V/50Hz  
 Dimensions: 455 x 205 x 137 mm  
 Weight: 5.2 kg



### LED STROBE

Strobe, 68x 5mm white led, 4prog/sound.

Code : B04705

44.90€ incl. VAT



68 LEDs of 5mm source  
 Variable frequency, sound mode and effects  
 Adjustment of modes, speed and dimmer by potentiometer  
 Power supply: 240V/50Hz  
 Dimensions: 132 x 188 x 164 mm  
 Weight: 0.5 kg



### LED MINI FLASH

Strobe, 20x 5mm white led, 1-20 FL/sec

Code : B04706

21.90€ incl. VAT



20 LEDs of 5mm source  
 Frequency variable from 0 to 20 Hz  
 Speed adjustment by potentiometer  
 Power supply: 240V/50Hz  
 Dimensions: 110 x 90 x 70 mm  
 Weight: 0.22 kg



# BLACK LIGHT



## UV-GUN 100W LED

UV projector with 100W "COB" LED

Code : B03807 449€ incl. VAT



UV 100W COB LED on individual reflector  
 Beam angle: 100°  
 DMX IN/OUT by XLR 3  
 4-digit display with drop-down menu IR remote control for:  
 Dimmer, Strobe, audio mode, Master/Slave  
 Regulated fan cooling  
 Power supply: AC 100/240V - 50/60Hz  
 Dimensions: 263 x 309 x 300 mm  
 Net weight: 4.1 Kg



## UV-BAR LED

Reliable ultraviolet LED light bar with many advantages over a traditional UV lamp

Code : B03806 219€ incl. VAT



12 UV 3W LEDs on individual reflector  
 Beam angle: 100°  
 DMX IN/OUT by XLR 3  
 4-digit display with drop-down menu IN/OUT power supply via IEC plug  
 IR remote control for:  
 Dimmer, Strobe, audio mode, Master/Slave  
 Convection cooling without fan  
 Power supply: AC 100/240V - 50/60Hz  
 Dimensions: 1050 x 93 x 88 mm  
 Net weight: 2.7 Kg



## LED-UV8

Black light projector with 8pcs 1W UV LEDs

Code : H9956 99€ incl. VAT



8 UV 1W LEDs on metal reflector  
 Beam angle: 65°  
 ON/OFF switch  
 Convection cooling without fan  
 Power supply: AC 100/240V - 50/60Hz  
 Dimensions: 160 x 80 x 60 mm  
 Net weight: 0.950 Kg



## LED-UV12

Floodlight with 12 3W UV LEDs

Code : H10288 189€ incl. VAT



12 UV 3W LEDs on individual reflector  
 Beam angle: 65°  
 4-digit display with drop-down menu  
 DMX IN/OUT by XLR 3  
 IN/OUT power supply by IEC plug  
 Convection cooling without fan  
 Power supply: AC 100/240V - 50/60Hz  
 Dimensions: 295 x 228 x 95 mm  
 Net weight: 2.2 Kg



# MIRROR BALLS



**MIRROR BALL 20/50 cm**  
Mirror ball 20"/50 cm

Code : B02026      70.90€ incl. VAT



**MIRROR BALL 16/40 cm**  
Mirror ball 16"/40 cm

Code : B02024      51.90€ incl. VAT

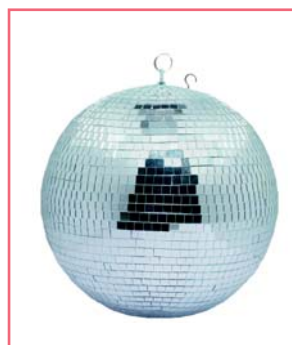

**MIRROR BALL 12/30 cm**  
Mirror ball 12"/30 cm

Code : B02023      24.90€ incl. VAT

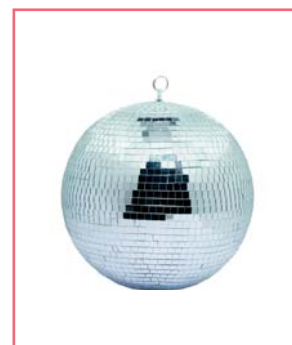

**MIRROR BALL 8/20 cm**  
Mirror ball 8"/20 cm

Code : B02022      11.90€ incl. VAT



**MIRROR BALL 4/10 cm**  
Mirror ball 4"/10 cm

Code : B02027      4.29€ incl. VAT



**MB ROTATOR Heavy duty**  
Motor for mirror balls up to a weight of 10 kg

Code : B04123      42.90€ incl. VAT



**MB ROTATOR STANDARD**  
Mirror ball motor: 1.5 rpm.

Code : B02021      16.90€ incl. VAT



**MB ROTATOR BATTERY**  
Motor for mirror balls with a maximum diameter of 20 cm

Code : B02020      6.90€ incl. VAT



# CONTROLLERS

Chromateq® offers innovative DMX lighting control solutions (lighting and multimedia) for professional architectural lighting and the entertainment world.

It is a solution adapted to all types of projects and for all sectors of activity: audio system, discos, theatres, concerts, live performances, LED installations, architectural lighting inside and outside, monuments, exhibitions and other services.

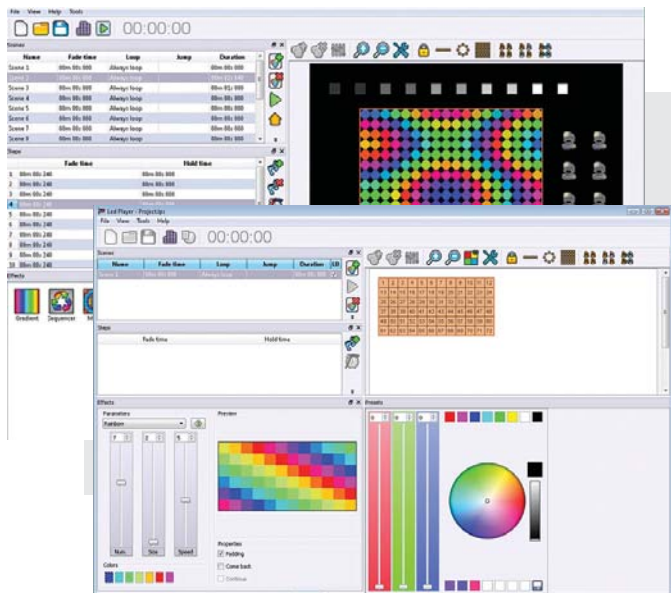

## LED PLAYER

Led Player is ideal for all DMX (architectural and entertainment) applications and fixed installations. It can control all standard DMX devices and can record a show in the interfaces. The LED Player is the easiest and most economical solution for DMX lighting control.



**LD-512WALL+**  
DMX wall controller.  
For CHROMATEQ software.

---

Code : B05016      309€ incl. VAT



**LD-512BOX**  
512-channel DMX interface with remote control IR  
For CHROMATEQ software

---

Code : B05005      185€ incl. VAT



**LD-1024BOX**  
DMX interface with 1024 DMX channels.  
For CHROMATEQ software

---

Code : B05006      289€ incl. VAT

**LD-512EASY+**  
512-channel DMX interface with 8 buttons.  
For CHROMATEQ software.

---

Code : B05012      299€ incl. VAT



Wall interface compatible with "Chromateq Led Player" software (supplied)  
512 DMX channels  
Internal memory for max. 255 scenes  
Activation by external contacts  
Access to 10 scenes by buttons  
Direct access to the interface:  
Trigger, Speed, Dimmer  
Calendar function  
Merger mode  
Operating system: Windows & MAC OSX & Linux  
DMX outputs on terminal block  
Power supply: By mini USB 5V or DC 9-36 V  
Art-Net Universe available: 1

Compact DMX interface  
Wall interface compatible with "Chromateq Led Player" software (supplied)  
IR remote control  
512 DMX channels  
256 channels in standalone  
Internal memory for max. 255 scenes  
IR remote control included for:  
Choice of scenes, speed, dimmer, BO  
Operating system: Windows & MAC OSX & Linux  
DMX outputs on XLR connectors  
Power supply: By mini USB 5V (cable supplied)  
Art-Net Universe available: 1

Standalone compact DMX interface  
Compatible with "Chromateq Led Player" and "Chromateq Pro DMX" software. (supplied)  
1024 DMX channels [2x512]  
132 channels in standalone  
Internal memory for max. 255 scenes  
IR receiver for optional remote control  
Operating system: Windows & MAC OSX & Linux  
DMX Inputs and Outputs on XLR and terminal block connectors.  
Power supply: By mini USB 5V (cable supplied)  
Art-Net Universe available: 2

Compact DMX interface  
"Chromateq Led Player" and "Chromateq Pro DMX". (supplied)  
512 DMX channels  
Internal memory for max. 255 scenes  
SD card slot for more memory  
Activation by external contacts  
Access to 80 programs by 8 buttons  
Direct access to the interface:  
Trigger, Page, Colour, Speed, Dimmer  
Calendar function  
Splitter mode 2x512  
Operating system: Windows & MAC OSX & Linux  
DMX outputs on XLR connectors  
Power supply: By mini USB 5V or DC 9-36 V  
Art-Net Universe available: 1

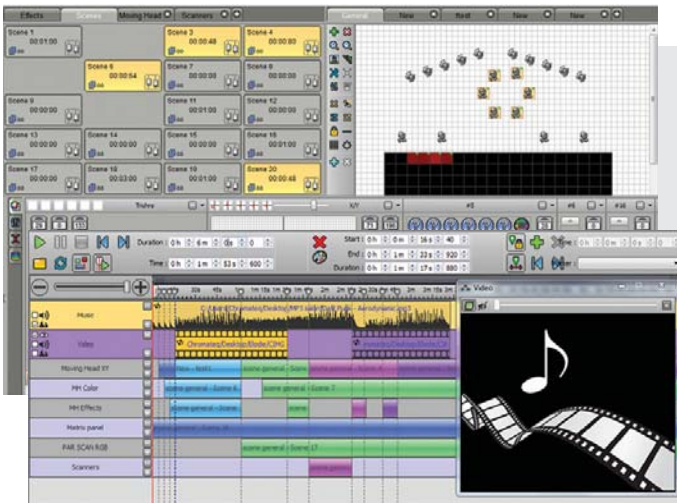

## PRO DMX

Professional software for experienced users and the production of quality shows. Thanks to the Timeline, it is the indispensable controller for Live performances and synchronizations in Audio, Video and lighting. Pro DMX will animate and embellish all your artistic creations easily.



## WI-LIGHT

The application can be used as a WIFI remote control with the LED Player software and LD-512WIFI interface. It can control all Live Board mode and standalone mode controls through a local WIFI connection. For smartphones and tablets.



### LD-512WIFI

DMX interface with 512 DMX channels. For CHROMATEQ software and Wi-Light app

Code : B05009 369€ incl. VAT



Compact DMX interface compatible with Wi-Light application.  
Compatible with "Chromateq Led Player" and "Chromateq Pro DMX" software. (supplied)  
512 DMX channels  
Internal memory for max. 3 x 255 scenes  
The application allows you to manage colours, speed and channels.  
Activation by external contacts  
Calendar function  
Operating system: Windows & MAC OSX & Linux  
DMX outputs on XLR power connectors:  
Supplied with external power supply (9 to 36 V) for use in standalone mode



### LD-1024DIN

DMX interface 1024 channels in DIN rail format. For CHROMATEQ software

Code : B05013 329€ incl. VAT



Interface in DIN rail format  
1024 DMX channels  
Compatible with "Chromateq Led Player" and "Chromateq Pro DMX" software. (supplied)  
Internal 4MB memory for storing programs.  
Internal memory for max. 255 scenes  
Activation by external contacts or optional remote control  
Calendar function  
Splitter mode 2x512  
Merger mode  
Chaining in Master/Slave possible  
Operating system: Windows & MAC OSX & Linux  
DMX inputs and outputs on connectors.  
Power supply: By mini USB 5V or DC 9-36V  
Art-Net Universe available: 1



### LD-512KIT-IR

Infrared set for CHROMATEQ interfaces

Code : B05011 45€ incl. VAT



Infrared set including 2 wireless remotes and 1 IR receiver board that can be installed anywhere in the room. Remote controls can also be used with LD standalone interfaces already integrating an IR receiver.

# CONTROLLERS

Software available in full French version

Windows  
macOS



- Version V8
- New functions
- Usability
- Efficiency
- Power

Windows  
macOS

**SWEETRACK**  
The ultimate 19-inch interface. For SWEET-LIGHT software

Code : H10485      849€ incl. VAT

**Contest**

Standalone interface capable of storing 18 scenes/chases.  
16 programs (previously programmed on Sweet Light) accessible and triggerable on the front  
Calendar function  
Indication: Power, USB link, DMX input  
Operating system: Windows & MAC  
Memories: 18  
DMX channel: 512  
DMX output: 3-pin female XLR with optical isolation  
DMX input: 3-pin male XLR with optical isolation  
Power supply: By USB or 9-12V, 300mA AC/DC  
Dimensions: 482 x 136 x 44mm  
Weight: 1.7 Kg

Windows  
macOS

**SWEET REMOTE**  
DMX interface with infrared remote control  
For SWEETLIGHT software

Code : H9635      699€ incl. VAT

**Contest**

Compact interface in a metallic box  
512 DMX channels - Unlimited number of projectors  
Access to 3D and DMX modes simultaneously integrated infrared sensor + connector for offset - Control your scenes from your remote control  
Standalone rendering of 10 scenes of 512 channels (4 simultaneous)  
Internal "date and time" calendar trigger  
Mini-Din connector for external contact triggering  
Windows and MacOS compatible  
Opto-isolated DMX output (surge protection)

Windows  
macOS

**SWEET D512**  
Compact, complete and standalone interface. For SWEETLIGHT software

Code : H9634      429€ incl. VAT

**Contest**

Compact interface in a metallic box  
512 DMX channels - Unlimited number of projectors  
Access to 3D and DMX modes simultaneously  
Thermal protection  
USB powered - USB Cable supplied  
Windows and MacOS compatible  
Standalone rendering of a 512-channel scene

Windows

**SWEET CABLE**  
DMX interface on USB stick. For SWEET-LIGHT software

Code : H8287      159€ incl. VAT

**Contest**

Compact and self-powered USB interface  
100 DMX channels, up to 20 simultaneous scenes  
Driver up to 10 DMX projectors  
Access to 3D mode or DMX  
Windows compatible

## 1 - SIMPLIFY YOUR LIGHT

- Quick and precise creation of your projectors under Setup
- Library containing most market models and all DMX Contest products
- Sharing your creations with other users on the forum
- Creating scenes with Editor like on traditional consoles
- Possibility of creating pallets to save time.
- Numerous simplification tools (Pan and Tilt with the mouse, RGB colours in 1 click, etc..)

## 2 - SAVE TIME

- Preparation, simulation and creation assisted in a few clicks
- Automatic patch creation, dip-switch position per projector
- Manage projectors in groups with multi-group management
- 3D simulation of your shows
- Possibility of repatching products without loss of programming.

- Creating complex scenes with offset management via Generator
- Record your favourite movements and reproduce them
- Copy, paste and cut your scenes at will

## 3 - MASTER LIVE

- One scene per button, organize your pages according to your needs
- Keyboard shortcuts, grouping, MIDI and DMX control
- Autonomous broadcast interfaces (Sweet-Remote, Sweet-Rack) controlled boot programs
- Simple creation of scenes with DMX, video, music and synchronized animated gifs
- Exemplary stability, even on the most modest configurations
- New Sequential List function

## 4 - BECOME THE ARCHITECT OF YOUR COLOURS

- Import your own visuals of buildings or spaces to showcase
- Determine the placement of your projectors
- Create Chaser, Text and Rainbow effects with ease



### SWEET-TELEC

Infrared remote control.  
For SWEET-REMOTE interface

Code : H9819

25€ incl. VAT



18 buttons to launch scenes  
Speed adjustment button:  
- Allows you to reduce the rendering speed of the scene  
+ Allows you to increase the rendering speed of the scene  
= Returns to the default programming speed

	CABLE	D512	REMOTE	RACK
<b>WITH A COMPUTER</b>				
Operating system	Windows	Win/Mac	Win/Mac	Win/Mac
Communication	USB	USB	USB	USB
Number of channels	100	DMX512 + 512 Artnet	DMX512 + 512 Artnet	DMX512 + 512 Artnet
Maximum number of interfaces	1	6	6	6
dmx input				✓
dmx optical isolation			✓	✓
<b>STANDALONE MODE</b>				
Number of dmx channels	0	512	512	512
Number of scenes (dynamic)		1	18	16
Number of zones		1	4	4
Number of push buttons				16
Infrared remote control			✓	
Calendar			✓	✓
External contacts			4	

## LIVE MOBILE

Control the show remotely

Live Mobile is available on AppStore for iPhone, iPad, and on the Market for Android smartphones.

- Download the full software for a FREE TRIAL on our site!
- Download updates, manuals, and tutorials regularly



[WWW.SWEETLIGHT-CONTROLLER.COM](http://WWW.SWEETLIGHT-CONTROLLER.COM)

# CONTROLLERS



## MEMORY-24

24-channel DMX console for power blocks

Code : H9067

229€ incl. VAT



Organ playing with 2 courses of 12 circuits or 1 course of 24 circuits  
4,600 memories and 48 programmable sequences  
Crossfade  
Adjustable speed and rise time of sequences  
Backup memories internally  
Possibility of mixing several sequences  
Sound mode  
Manual triggering by Tap synchro  
Triggering scenes and sequences in MIDI  
DMX 512 output on 3-pin XLR plug  
External power supply (DC 9 V - 12 V, 500 mA)  
Dimensions: 483 x 265 x 90mm  
Weight: 4.6 kg



## PILOT-192PRO

192-channel DMX controller with joystick

Code : H9073

169€ incl. VAT



192 channels (12 projectors of 16 channels)  
30 banks of 8 programs each  
12 chases (240 steps per chase)  
Pan/Tilt  
Fade Time  
MIDI control of memories and blackout  
Assignable joystick for Pan/Tilt movements  
Connection for foot control and smoke machine  
Sound mode  
Dimensions: 483 x 82 x 135 m  
Weight: 2.2 kg



## SCM-1 SCENEMASTER

16 DMX channels with MIDI output

Code : B04624

189€ incl. VAT



64 channels (4 projectors of 16 channels)  
16 scenes of 16 channels  
MIDI control of faders and flashes  
Midi In controls scenes with compatible software  
16 buttons for flashes or scenes  
Dimensions: 483 x 85 x 133 m  
Weight: 2.5 kg



## LEDCON-XL

LEDCON-XL controller

Code : B04661

179€ incl. VAT



64 channels (8 projectors with 8 channels each) patchable  
Control of colours, fades and chases.  
8 faders for other functions  
4- or 8-channel modulators with speed control or sound mode  
Choice of RGB, white RGB, amber white RGB modes, etc.  
UV button for 6-in-1 LED projectors that include a UV LED.  
Separate control for strobe and dimmer.  
Instant access to 9 preprogrammed colour chasers  
Static or audio chaser mode 32-colour spectral blend.  
Dimensions: 483 x 75 x 133 m  
Weight: 2.2 kg



## CONTROLLER CASE 3U

Compact flight case for all kinds of small 19" controllers

Code : B03224

79€ incl. VAT

Compact flight case for controllers  
19" up to 3U  
Accessory compartment  
Rubber feet







### PILOT-8

Programmable 8x8 channels controller

Code : H10126 199€ incl. VAT



64 patchable channels (8 projectors with 8 channels each)  
 8 colours recorded and 24 free  
 8 pre-programmed colours and 24 free  
 Assignable patch for RGBWA and dimmer functions  
 2 assignable free channels  
 Strobe function  
 Adjustable sequence speed  
 Connectors:  
 - DMX output on XLR  
 - RJ45 for DMX control of the Contest Architecture range using the PILOT  
 - Jack for external controller Easy-2 for launching programs, choice of colours and Blackout  
 - USB for the night light supplied  
 Dimensions: 400 x 200 x 68 mm  
 Weight: 2.3 kg



### MANU-6X

DMX 6 channels + master controller

Code : H9064 65€ incl. VAT



6-channel DMX console  
 6 faders + Master  
 Operates on 9 V battery  
 Supplied AC adapter  
 Ideal for the control of architectural colour changers  
 DMX output: 3-pin XLR  
 Dimensions: 173 x 153 x 55 mm  
 Weight: 0.8 kg



### PARCONTROL34

RGB and RGBW compatible DMX controller

Code : H9913 89€ incl. VAT



Control of colour, prog, strobe.  
 Direct access to 12 colours and 3 shades of whites  
 RGBW colour graduation  
 Audio mode  
 Strobe speed  
 2 control modes  
 Mode 1: R,G,B, Dim/Strobe, White  
 Mode 2: R,G,B,White  
 Power supply: DC 9-12V 300mA  
 Dimensions: 270 x 170 x 60 mm  
 Weight: 1.1 Kg



### PARCONTROL

DMX controller for RGB projector

Code : H9406 69€ incl. VAT



Control of colour, prog, strobe.  
 Direct access to 9 colours  
 RGB colour graduation  
 Audio mode  
 Strobe speed  
 Fixed patch R, G, B, Dimmer/Strobe.  
 Power supply: DC 9-12V 300mA  
 Dimensions: 220 x 140 x 36 mm  
 Weight: 1 Kg



### LEDCON-02 Mk2

Small pre-programmed LED controller

Code : B04660 91.90€ incl. VAT



Control of colour, prog, strobe.  
 Direct access to 9 colours  
 Faders for chasers, speed and Dimmer  
 Audio mode  
 Fixed patch R,G,B, Dimmer/Strobe  
 Works in 4 or 8 channel mode  
 Power supply: DC 9-12V 300mA  
 Dimensions: 210 x 140 x 46 mm  
 Weight: 1 Kg



### PARPILOT

DMX control box for PAR LEDs CONTEST and LED4STAGE

Code : H9658 39€ incl. VAT



Control of colour, prog, strobe.  
 2 control modes: Fixed colour and running light  
 Fixed patch R,G,B, Dimmer/Strobe  
 Works in 4 or 16 DMX channels  
 10 pre-memorized internal programs  
 Musical Mode, Tap Tempo and Colour Variation  
 Quick access to 8 fixed colours  
 Management of scroll speed and intensity  
 Strobe effect  
 Net or progressive colour chaining  
 Blackout  
 Power supply: DC 12 V 100 mA (supplied)  
 Dimensions: 70 x 110 x 33 mm  
 Weight: 0.31 kg

# CONTROLLERS



## CA-8

Remote compatible with most lighting effects

Code : B04192 16.90€ incl. VAT



Colour/gobo control of programs and of Blackout.  
Connectivity: 6.35 stereo jack  
Cable length: 11 m



## EASY-2

Universal remote control for Contest devices

Code : H8701 19€ incl. VAT



Colour/gobo control of programs and of Blackout.  
Connectivity: 6.35 stereo jack  
Cable length: 11 m



## BT-STR4

4-channel controller for strobes.

Code : B04712 59€ incl. VAT



Strobe controller  
Analog outputs and DMX (2-channel)  
Manual or automatic operation 10 different programs  
Single flash, Full on / Blinder, Blackout  
Adjustable speed  
Dimmer (only in DMX)  
Audio mode  
Compatible with analog strobes using 12V DC pulses such as: MEGA STROBE 1500, ...  
Compatible with DMX strobes using 2 channels such as: MEGA STROBE 1500 DMX, BT-STROBE 3000, ...



## FL-01CX

Strobe controller, analog pulses

Code : B02029 23.90€ incl. VAT



1-channel controller for strobes  
Manual or automatic operation  
Adjustable speed: 1 to 12 bursts per second  
Up to 4 possible strobes  
Mono jack/jack cable to be ordered separately (e.g. 2-0426)  
Compatible with: FL1800, STR300, FL045/B, ZAP Strobes



## DMS-26

The perfect all-in-one solution for securing your DMX installations: MERGER + SPLITTER + BOOSTER.

Code : B04625 209€ incl. VAT



SPLITTER:  
100% electrical insulation  
2 inputs and 6 DMX outputs  
BOOSTER:  
signal reconstruction  
MERGER:  
Mixer:  
HTP: Priority to the highest value  
Backup: if signal A is faulty then relay on signal B  
Priority channel address per input.  
DMX speed 23 ms to 45 ms.  
Signal loss setting:  
Null, Hold, Clear  
4-character LED display.  
Dimensions: 482 x 150 x 44 mm  
Weight: 2.9 kg



## DS 12

PRO splitter DMX+IEC 1in/2out

Code : B04631 119€ incl. VAT



SPLITTER:  
100% electrical insulation  
1 input and 2 DMX outputs  
BOOSTER:  
signal reconstruction  
Bidirectional RDM compatible  
Inputs:  
DMX 3 and 5 XLR  
IEC 10A  
Outputs:  
2 DMX XLR3  
2 IEC 10A  
Dimensions: 130 x 132 x 56 mm  
Weight: 0.95 kg



## SPLIT-2

DMX line splitter of 1 input 2 outputs

Code : H7546 89€ incl. VAT



SPLITTER:  
100% electrical insulation  
1 input and 2 DMX outputs  
BOOSTER:  
signal reconstruction  
Inputs:  
DMX 3 and 5 XLR  
Outputs:  
2 DMX 3 and 5 XLR  
Overvoltage protection on each channel by fuse: 500 mA - 250 V  
Signal presence indicators  
Dimensions: 245 x 165 x 72 mm  
Weight: 1.9 kg



**MINI DMX-SPLITTER**  
Mini DMX splitter 1in/2out

Code : B04630 39€ incl. VAT



**SPLITTER:**  
100% electrical insulation  
1 input and 2 DMX outputs  
**BOOSTER:**  
signal reconstruction  
Inputs:  
DMX XLR 3  
Outputs:  
2 DMX XLR3  
Dimensions: 102 x 72 x 40 mm  
Weight: 0.24 kg



**airBOX-ER1**  
Wireless DMX transmitter and receiver box of 512 DMX channels and 7 WiFi frequencies

Code : H9966 119€ incl. VAT



Transceiver operation in automatic transmitter and receiver  
- ISM 2.400-2.483GHz frequency band  
Channel selection button with tricolour LED  
Choice of 7 different channels to make groups of projectors  
Power supply:  
- AC 100/240 V - 50/60 Hz  
Input and output power  
DMX input and output on XLR3  
Maximum transmission power: 20 dBm/100 mW  
Removable bracket for hanging on structures and wall attachment  
Dimensions: 165 x 120 x 53 mm  
Net weight: 0.5 kg



**M-DMX TRANSCEIVER**  
Wireless DMX! Compatible with WTR-DMX DONGLE.

Code : B04646 99€ incl. VAT



Transceiver can operate in transmitter or receiver mode  
- 2.4 GHz frequency band  
Compatible with the "Wireless Solution" W-DMX™ Protocol  
Works perfectly with Briteq WR-DMXG4 (4632) in WT-DMXG4 (4633)  
5V DC power supply via micro USB or adapter included  
DMX input and output on XLR3  
Dimensions: 103 x 76 x 36 mm  
Net weight: 0.250 kg



**WTR-DMX DONGLE**  
The perfect solution for anyone looking for an extremely reliable wireless DMX!

Code : B04645 59€ incl. VAT



Transceiver can operate in transmitter or receiver mode  
- 2.4 GHz frequency band  
Compatible with the "Wireless Solution" W-DMX™ Protocol  
Works perfectly with Briteq WR-DMXG4 (4632) in WT-DMXG4 (4633)  
5V DC power supply via USB port  
DMX connection via USB port  
Dimensions: 71 x 42 x 11 mm  
Net weight: 0.02 kg



**FIRMWARE UPDATER**  
This device allows you to do firmware updates on DMX projectors and light effects.

Code : B04319 42.90€ incl. VAT



Firmware update box for compatible devices.  
Works with the software that allows you to load the program via the USB port.  
Possible to update multiple devices in one time.  
Check the compatibility of your device.



**FIRMWARE UPDATER 2**  
Standalone programmer that makes it easy to update the firmware of projectors on site.

Code : B04379 39€ incl. VAT



Firmware update box for compatible devices. The update is loaded on the micro-SD card  
Possible to update multiple devices in one time.  
Possible to store firmware files for different projectors.  
Charging the internal battery via a mini USB input.  
Output: 3-pin XLR  
USB stick adapter/micro-SD card  
Supplied with mini USB cable and micro-SD card  
Check the compatibility of your device.



**FIRMWARE UPDATER 3**  
Firmware update cable

Code : B04389 29€ incl. VAT



Firmware update cable for compatible devices.  
Works with the software that allows you to load the program via the USB port.  
Possible to update multiple devices in one time.  
Check the compatibility of your device.



**DMS-26**

The perfect all-in-one solution to secure your installations.

# ELECTRICAL DISTRIBUTION



## DIM-6X16

6x16A DMX 6-channel block with faders

Code : H9058 359€ incl. VAT



Power rating: 16 A (3500 W) per channel / 96 A max. resistive/inductive  
 Protection of each channel by bipolar circuit breaker  
 LEDs indicating charge presence on each channel  
 DMX addressing Dip Switch  
 6 linear potentiometers for manual dimming  
 Power supply: single-phase or three-phase on internal terminal blocks (230 V - 50 Hz)  
 6 16A French plug outputs on the back  
 DMX input and output: on 3-pin XLR connectors  
 Dimensions: 482 x 390 x 90  
 Weight: 7 kg



## BT-626/FRA

6-channel professional Dimmer/Switch pack for rack mounting 19".

Code : B04634 429€ incl. VAT



Power rating: 16 A (3500 W) per channel / 96 A max. resistive/inductive  
 Protection of each channel by circuit breaker  
 LEDs indicating charge presence on each channel  
 Independent addressing of each channel  
 6 linear potentiometers for manual dimming  
 Preheat control of lamps from 0 to 6%  
 LED display to monitor all functions, including internal temperature  
 Power supply: single-phase or three-phase on terminal blocks (230 V - 50 Hz)  
 6 16A French plug outputs on the back  
 DMX XLR 3 and RJ11 input and output  
 0/10V input on DB9  
 Dimensions: 482 x 312 x 90  
 Weight: 8 kg



## BT-626/GER

6-channel professional Dimmer/Switch pack for rack mounting 19".

Code : B04635 429€ incl. VAT



Same as BT-626/FRA but with outputs on 6 standard German plugs.



## DSP-4 Mk2 /F

Multifunctional dimmer/switch pack with 4 sockets (French Schuko).

Code : B04643 219€ incl. VAT



Power rating: 8 A (1850 W) per channel / 15 A max. resistive/inductive  
 Protection of each channel by fuse  
 Independent addressing of each channel  
 LED display with drop-down menu  
 Power supply: 240V - 50Hz single phase  
 4 16A French plug outputs on the front  
 DMX XLR 3 input and output  
 Dimensions: 482 x 100 x 88  
 Weight: 2.9 kg



## DSP-4 Mk2 /G

Multifunctional dimmer/switch pack with 4 sockets (German Schuko).

Code : B04644 219€ incl. VAT



identical to the DSP-4 MK2 but with outputs on 4 standard German plugs.





### DIM-1X10

1-channel 1x10A DMX block with PC output fader

Code : H9061

99€ incl. VAT



Power rating: 10 A (2200W) resistive/ inductive  
 Linear potentiometers for manual dimming  
 Cable length of the remote fader: 1.8 m  
 LED display with drop-down menu  
 DMX input/output on 3-pin XLR plugs  
 Output on French plug  
 Power supply: AC 230 V, 50 / 60 Hz  
 Dimensions: 150 x 125 x 82 mm  
 Weight: 1.5 kg

### DIM-4X5

4-channel 4 x 5A compact DMX block with faders

Code : H9057

179€ incl. VAT



Power rating: 5 A (1100 W) per channel / 16 A max. resistive/inductive  
 16 internal chase programs with variable speed  
 Individual fader per channel, with speed adjustment  
 4 DMX channels with independent assignment in DMX 512  
 Modes: Master/slave, program, DMX, sound via build-in microphone.  
 Switch/dimmer pack  
 Control of 4 DMX channels via faders  
 Outputs on 4 French mains plugs  
 Power supply: AC 120 V / 230 V - 50 / 60 Hz, 16 A maximum  
 Dimensions: 250 x 208 x 68 mm  
 Weight: 2.5 kg

### RG8USB

1U rackable strip, 8 European plugs + 2xUSB

Code : H10840

39€ incl. VAT



1U rackable 19" strip with:  
 8 sockets on the back  
 2 USB ports (1A) on the front  
 1 bipolar switch on the front panel to control the outlets  
 Standard German plugs with child protection  
 3G1.5mm<sup>2</sup> cable - length 2m  
 Dimensions: 483 x 46 x 90 mm  
 Power supply: 230V - 50 Hz  
 Weight: 1 kg



### PC-8 Mk2 FRA/BEL

8-channel dispatch with bipolar switches

Code : B02049

89€ incl. VAT



Outputs on 8 IP54 outlets  
 Standard French plugs  
 8 bipolar switches  
 6.3 amp fuse for each channel  
 the total charge cannot exceed 15 amps (3300 W)  
 Rackable 19 inches / 2U  
 Dimensions: 483 x 80 x 97 mm  
 Power supply: 230V - 50 Hz  
 Weight: 2 kg

### PC-8 Mk2 GER

8-channel dispatch with bipolar switches

Code : B02059

89€ incl. VAT



Outputs on 8 IP54 outlets  
 Standard German plugs  
 8 bipolar switches  
 6.3 amp fuse for each channel  
 the total charge cannot exceed 15 amps (3300 W)  
 Rackable 19 inches / 2U  
 Dimensions: 483 x 80 x 97 mm  
 Power supply: 230V - 50 Hz  
 Weight: 2 kg

### RG2x8

1U double-sided rackable strip, 2x8 European plugs

Code : H10837

69€ incl. VAT



1U rackable 19" strip with:  
 8 sockets in front / 16A protection  
 8 sockets at the rear / 16A protection  
 2 front bipolar switches to control front outlets and rear outlets  
 Standard German plugs with child protection  
 3G1.5mm<sup>2</sup> cable - length 2m  
 Dimensions: 483 x 46 x 90 mm  
 Power supply: 230V - 50 Hz  
 Weight: 1.33 kg

# ELECTRICAL DISTRIBUTION



## PD-63SH/FRA-BEL

Distributor 63A Tetra / 12x16A Mono + 2x 16PIN + 2x19PIN + 1 CEE 63A output.

Code : B04647

1039€ incl. VAT



1 x 63A 4-pole circuit breaker (3P+N) for protection of all outputs, including 63A output  
 1 x 30 mA 63A differential circuit breaker for the protection of persons  
 12 x bipolar circuit breakers for 12 16A standard French outlets (4 outlets per phase)  
 V-meters + A-meters per phase  
 1.5 m mains input cable with CEE 63A plug  
 1 x CEE 63A output connector  
 2 x 16-pin Harting type connector  
 2 x 19 pin socapex type connector  
 Dimensions: 482 x 266 x 326 mm  
 Rackable 19" height 6U  
 Power supply: 400V - 50 Hz (3P+N+E)  
 Weight: 11.74 kg



## PD-63SH/GERMAN

Distributor 63A Tetra / 12x16A Mono + 2x 16PIN + 2x19PIN + 1 CEE 63A output.

Code : B04648

1039€ incl. VAT



1 x 63A 4-pole circuit breaker (3P+N) for protection of all outputs, including 63A output  
 1 x 30 mA 63A differential circuit breaker for the protection of persons  
 12 x bipolar circuit breakers for 12 16A standard German outlets (4 outlets per phase)  
 V-meters + A-meters per phase  
 1.5 m mains input cable with CEE 63A plug  
 1 x CEE 63A output connector  
 2 x 16-pin Harting type connector  
 2 x 19 pin socapex type connector  
 Dimensions: 482 x 266 x 326 mm  
 Rackable 19" height 6U  
 Power supply: 400V - 50 Hz (3P+N+E)  
 Weight: 11.74 kg



## PD-63A Mk2/FRA-BEL

Distributor 63A Tetra / 2 x outputs CEE 32A + 3 x 16A Mono.

Code : B04639

629€ incl. VAT



1 x 30 mA 63A differential circuit breaker for the protection of persons  
 2 x 32A 4-pole circuit breakers (3P+N) for the protection of two P17 32A outputs  
 3 x bipolar circuit breakers for 3 16A standard French outlets (1 outlet per phase)  
 V-meters + A-meters per phase  
 1.5 m mains input cable with CEE 63A plug  
 2 x CEE 32A output connectors  
 Dimensions: 482 x 274 x 152 mm  
 Rackable 19" height 3U  
 Power supply: 400V - 50 Hz (3P+N+E)  
 Weight: 11.74 kg



## PD-63A Mk2/GER-NL

Distributor 63A Tetra / 2 x outputs CEE 32A + 3 x 16A Mono.

Code : B04640

629€ incl. VAT



1 x 30 mA 63A differential circuit breaker for the protection of persons  
 2 x 32A 4-pole circuit breakers (3P+N) for the protection of two P17 32A outputs  
 3 x bipolar circuit breakers for 3 16A standard German outlets (1 outlet per phase)  
 V-meters + A-meters per phase  
 1.5 m mains input cable with CEE 63A plug  
 2 x CEE 32A output connectors  
 Dimensions: 482 x 274 x 152 mm  
 Rackable 19" height 3U  
 Power supply: 400V - 50 Hz (3P+N+E)  
 Weight: 11.74 kg



### PD-32SH/FRA-BEL

Distributor 32A Tetra / 6 x 16A Mono + 1 x 16PIN + 1x19PIN + 1 x CEE 32A output.

Code : B04636

529€ incl. VAT



1 x 30 mA 32A differential circuit breaker for the protection of people  
 1 x 32A 4-pole circuit breaker (3P+N) for protection of all outputs, including the 32A output  
 6 x bipolar circuit breakers for 6 16A standard French outlets (2 outlets per phase)  
 V-meters + A-meters per phase  
 1.5 m mains input cable with CEE 32A plug  
 1 x CEE 32A output connector  
 2 x 16-pin harting type connector  
 2 x 19 pin socapex type connector  
 Dimensions: 482 x 258 x 152 mm  
 Rackable 19" height 3U  
 Power supply: 400V - 50 Hz (3P+N+E)  
 Weight: 8.78 kg



### PD-32SH/GERMAN

Distributor 32A Tetra / 6 x 16A Mono + 1 x 16PIN + 1x19PIN + 1 x CEE 32A output.

Code : B04637

529€ incl. VAT



1 x 30 mA 32A differential circuit breaker for the protection of people  
 1 x 32A 4-pole circuit breaker (3P+N) for protection of all outputs, including the 32A output  
 6 x bipolar circuit breakers for 6 16A standard German outlets (2 outlets per phase)  
 V-meters + A-meters per phase  
 1.5 m mains input cable with CEE 32A plug  
 1 x CEE 32A output connector  
 2 x 16-pin harting type connector  
 2 x 19 pin socapex type connector  
 Dimensions: 482 x 258 x 152 mm  
 Rackable 19" height 3U  
 Power supply: 400V - 50 Hz (3P+N+E)  
 Weight: 8.78 kg



### BREAK-3X32

3x32A power supply block on 6 outlets and 1CEE32 - vu-meter

Code : H9070

529€ incl. VAT



1 x 30 mA 32A differential circuit breaker for the protection of people  
 6 x bipolar circuit breakers for 6 16A standard French outlets (2 outlets per phase)  
 V-meters + A-meters per phase  
 AC input cable with CEE 32A plug  
 1 x CEE 32A output connector  
 Dimensions: 482 x 260 x 152 mm  
 Rackable 19" height 3U  
 Power supply: 400V - 50 Hz (3P+N+E)  
 Weight: 7 kg



### BREAK-3X16

3x16A power supply block on 6 outlets with vu-meter

Code : H9059

329€ incl. VAT



3 x bipolar circuit breakers for 6 16A standard French outlets (2 outlet per phase)  
 V-meters + A-meters per phase  
 1 x CEE 32A input connector  
 1 x 16A socket in front on phase 1  
 Dimensions: 482 x 260 x 152 mm  
 Rackable 19" height 2U  
 Power supply: 400V - 50 Hz (3P+N+E)  
 Weight: 3.8 kg

# ELECTRICAL DISTRIBUTION

**NEW**



**DIST3x2F**  
TRI 1xCEE16A distributor - 3x2 French outlets

Code : H10838      69€ incl. VAT



**NEW**



**DIST3x2E**  
TRI 1xCEE16A distributor - 3x2 European outlets

Code : H10839      69€ incl. VAT



**NEW**



**DIST-CUBE**  
Tri 1xCEE16A distributor / 3 x European outlets

Code : H10868      35€ incl. VAT



Rackable distributor 19" height 1U  
Power input cable in 5G1.5mm<sup>2</sup> with a length of 2 m + Tetra CEE 16A plug  
6 16A standard French sockets on the front (2 outlets per phase)  
Weight: 1.1 Kg

Rackable distributor 19" height 1U  
Power input cable in 5G1.5mm<sup>2</sup> with a length of 2 m + Tetra CEE 16A plug  
6 16A standard German sockets on the front (2 outlets per phase)  
Weight: 1.1 Kg

Cube format distributor  
2 M10inserts  
Tetra CEE 16A input plug  
3 16A standard German plugs (1 outlet per phase)  
Dimensions: 160 x 136 x 102 mm  
Weight: 0.86 Kg





# LIFTING CONTROL



## RICO-V8

8-channel chain lift motor controllers with separate UP / DOWN buttons and master / slave function.

Code : B07000 1250€ incl. VAT



Standalone controller for chain lift motors. Control up to 8 motors independently. Compatible with the RICO-V4 model. Multiple units can be connected as master/slave. Simultaneous control of the hoists using the UP/DOWN buttons on the master controller. Emergency stop. "Slave" LED indicator light. Manual phase inversion switch for each output. Choice of different outputs: 4 16 A outputs, 4 individual CEE poles. 2x 16-pin connectors, Harting® type. 2x 19-pin connectors, Socapex® type. 1x PowerCON 16 A power outlet. XLR input for the remote control [RICO-REMOTE] (optional). Phase indicators available. A 4-pole 32A circuit breaker protects ALL outlets, including the 32A output to the next unit in the chain. In case of emergency, all the phases AND the neutral are disconnected. 2x C16 bipolar automatic circuit breakers (16 A - 1P+N) for the protection of circuits + auxiliary output. AC input cable (3 x 32 A, 5 wires), equipped with CEE 32 A input socket (3P+N+T). Output connector bypass (3 x 32 A, 5 wires) of EEC type (3P+N+T) (19 inches)/4 U rugged metallic box. Designed and manufactured in Europe. Dimensions: 482 x 184 x 430 mm. Power supply: 400V - 50 Hz (3P+N+E). Weight: 13.5 kg.



## RICO-V4

4-channel chain lift motor controllers with separate UP / DOWN buttons and master / slave function.

Code : B04649 849€ incl. VAT



Standalone controller for chain lift motors. Control up to 4 motors independently. Multiple units can be connected as master/slave. Simultaneous control of the hoists using the UP/DOWN buttons on the master controller. Emergency stop. "Slave" LED indicator light. Manual phase inversion switch for each output. Choice of different outputs: 4 16 A outputs, 4 individual CEE poles. 1x 16-pin connectors, Harting® type. 1x 19-pin connectors, Socapex® type. 1x PowerCON 16 A power outlet. XLR input for the remote control [RICO-REMOTE] (optional). Phase indicators available. A 4-pole 32A circuit breaker protects ALL outlets, including the 32A output to the next unit in the chain. In case of emergency, all the phases AND the neutral are disconnected. 2x C16 bipolar automatic circuit breakers (16 A - 1P+N) for the protection of circuits + auxiliary output. AC input cable (3 x 32 A, 5 wires), equipped with CEE 32 A input socket (3P+N+T). Output connector bypass (3 x 32 A, 5 wires) of EEC type (3P+N+T) (19 inches)/4 U rugged metallic box. Designed and manufactured in Europe. Dimensions: 482 x 184 x 430 mm. Power supply: 400V - 50 Hz (3P+N+E). Weight: 13.5 kg.



## RICO-REMOTE

Remote control for RICO-V4 and RICO-V8

Code : B04650 125€ incl. VAT



Equipped with:  
2 UP / DOWN buttons  
1 backlit emergency stop button  
1 6.5m cable (XLR 5pin male / female)

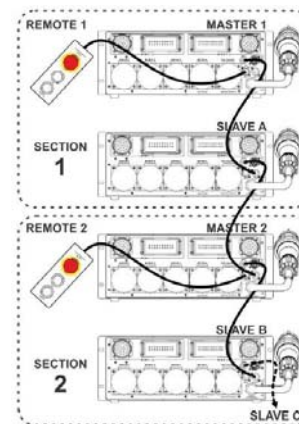



# EFFECT MACHINES

SMOKE, FOG, BUBBLE AND SNOW  
MACHINES  
PERFUMES AND LIQUIDS



# EFFECT MACHINES



**F-7 Smaze**  
All-in-one solution: fog and mist modes

Code : B04844      1989€<sup>Incl. VAT</sup>



Tank: 5 litres  
Preheating time: 8 minutes  
Output volume:  
Fog mode: 650 m3 per minute  
Faze mode: 170 m3 per minute  
Max. consumption  
Fog mode: 140 ml/min  
Faze mode: 28 ml/min  
Control panel: LCD screen, smoke volume and diffusion fan speed management  
DMX mode: 3 channels  
Integrated DMX wireless receiver:  
Use liquid:  
Power supply: 230V - 50Hz  
Power consumption: 1650W max.  
Dimensions: 710 x 412 x 710 mm  
Net weight: 52.5 Kg



**HZ-500**  
Hazer machine

Code : B04817      1590€<sup>Incl. VAT</sup>



Tank: 2.5 litres  
Output volume: 85 m3 per minute  
Max. consumption: 1.1ml/min  
Control panel: LCD display  
Volume and Timer Mode  
DMX mode: 1 channel  
Noise level: lower than 70 dB from 10cm  
Use hazer liquid HZL-5  
Power supply: 230V - 50Hz  
Power consumption: 480W max.  
Dimensions: 490 x 351 x 338 mm  
Net weight: 31.5 Kg



**HZ-350**  
Hazer machine

Code : B04826      749€<sup>Incl. VAT</sup>



Tank: 2.5 litres  
Output volume: 57 m3 per minute  
Max. consumption: 0.8 ml/min  
Control panel: LCD display  
Volume and Timer Mode  
DMX mode: 1 channel  
Wireless remote included  
Use hazer liquid HZL-5  
Power supply: 230V - 50Hz  
Power consumption: 390 W max.  
Dimensions: 492 x 273 x 314.5 mm  
Net weight: 14.2 Kg





**F-5D**  
Fazer machine trustworthy and efficient.

Code : B04846      1369€<sup>Incl. VAT</sup>



Heating element: 800W  
Preheating time: 4 minutes  
Tank: 2.8 litres  
Output volume: 85 m3 per minute  
Max. consumption 3ml/min at 100%  
Control panel: LCD screen, smoke volume and diffusion fan speed management  
DMX mode: 2 channels  
Integrated DMX wireless receiver:  
Use liquid:  
Power supply: 230V - 50Hz  
Power consumption: 800W max.  
Dimensions: 535 x 465 x 225 mm  
Net weight: 22.9 Kg



**HAZETEC**  
Smoke / Fazer machine

Code : H10487      699€<sup>Incl. VAT</sup>



Heating element: 1400W (preheating), 90W (operation)  
Preheating time: 46 seconds  
Tank: 6 litres  
Output volume: 99m3 per minute  
Max. consumption 17ml/min at 100%  
Control panel with smoke volume and diffusion fan speed management  
2 DMX channels: Smoke volume and diffusion fan speed  
Use liquid:  
Power supply: 230V - 50Hz  
Power consumption: 900W max.  
Dimensions: 343 x 364 x 290 mm  
Net weight: 11.9 Kg



**FLY-HAZETEC**  
Flight case for HAZETEC

Code : H10510      269€<sup>Incl. VAT</sup>





**FazeTEC**  
Hazer 700W

Code : H10204 369€<sup>Incl. VAT</sup>



Heating element: 700W  
Preheating time: 4 minutes  
Tank: 1.3 litres  
Output volume: 85m<sup>3</sup>/min  
Max. consumption: 3ml/min at 100%  
Control panel with smoke volume and fan management  
2 DMX channels: Smoke/fan  
Use liquid: **HD5L**  
Power supply: 230V - 50Hz  
Power consumption: 900W max.  
Dimensions: 320 x 153 x 391 mm  
Net weight: 8.8 kg



**CTL-FazeTec**  
Remote Volume/On/Off for FazeTEC

Code : H10246 39€<sup>Incl. VAT</sup>



Wired remote for FazeTEC  
Connector: stereo jack 6.35 mm  
Function: Volume, start/stop



**Z-380**  
Hazer machine

Code : B04847 499€<sup>Incl. VAT</sup>



Heating element: 1500W  
Preheating time: 1.5 minutes  
Tank: 1.2 litres  
Output volume: 170m<sup>3</sup>/min  
Max. consumption: 6 ml/min at 100%  
Control panel with smoke volume and fan management  
DMX mode: 1 or 2 channels  
Use liquid:  
Power supply: 230V - 50Hz  
Power consumption: 1500W  
Dimensions: 328 x 248 x 265 mm  
Net weight: 8.48 kg



**Z-350**  
Fazer

Code : B04828 379€<sup>Incl. VAT</sup>



Heating element: 700W  
Preheating time: 4 minutes  
Tank: 1.3 litres  
Output volume: 85m<sup>3</sup>/min  
Max. consumption: 3ml/min at 100%  
Control panel with smoke volume and fan management  
2 DMX channels: Smoke/fan  
Use liquid:  
Power supply: 230V - 50Hz  
Power consumption: 900W max.  
Dimensions: 320 x 153 x 391 mm  
Net weight: 8.8 kg



**Z-3**  
ANTARI wired remote Z-350

Code : B04829 45€<sup>Incl. VAT</sup>



Wired remote for Z-350  
Connector: stereo jack 6.35 mm  
Function: Volume, start/stop



**FAZE-700**  
Fazer

Code : B04891 209€<sup>Incl. VAT</sup>



Heating element: 700W  
Preheating time: 3 minutes  
Tank: 1.2 litres  
Output volume: 39.65 m<sup>3</sup>/min  
Adjustable fog output:  
Via the integrated control panel.  
Via wired remote (included).  
Use liquid: **FOG LIQUID HI-TECH** or **FOG LIQUID STD**  
Power supply: 230V - 50Hz  
Power consumption: 700W  
Dimensions: 300 x 147 x 290 mm  
Net weight: 5 kg

# EFFECT MACHINES

**NEW**



**FT-200**  
Smoke machine - 1600 W designed for fire training

Code : B04881      999€<sup>Incl. VAT</sup>





**FT-100**  
Smoke machine - 1500 W designed for fire training

Code : B04880      729€<sup>Incl. VAT</sup>



**NEW**



**FT-20**  
Portable smoke machine 600 W on batteries designed for fire training

Code : B04882      999€<sup>Incl. VAT</sup>



Heating element: 1600W  
Preheating time: 7 minutes  
Tank: 2.4 litres  
Max. consumption 270 ml/min at 100%  
Coverage: Height 8 metres  
Control panel: LCD display  
Volume and Timer Mode  
DMX mode: 1 channel  
Wireless W-2 remote included  
Z-3 remote optional  
Use liquid FLP-6  
Power supply: 230V - 50Hz  
Power consumption: 1600 W max.  
Dimensions: 301 x 194 x 414 mm  
Net weight: 16 Kg

Heating element: 1500W  
Preheating time: 7.5 minutes  
Tank: 6 litres  
Max. consumption 100 ml/min at 100%  
Output volume: 560 m3 per minute  
Control panel: LCD display  
Volume and Timer Mode  
DMX mode: 1 channel  
Wireless W-2 remote included  
Z-3 remote optional  
Use liquid FLP-6  
Power supply: 230V - 50Hz  
Power consumption: 1500 W max.  
Dimensions: 580 x 278 x 264 mm  
Net weight: 14.6 Kg

Heating element: 600W  
Battery: DC 12V  
Preheating time: 1 sec  
Tank: 0.4 litres  
Max. consumption 16 ml/min at 100%  
Control panel:  
Manual: on/off  
DMX mode: 1 channel  
WTR-20 optional  
Z-3 remote optional  
Use liquid FLP-6  
Charger: AC 230V - 50Hz / DC 12V  
Power consumption: 600 W max.  
Dimensions: 580 x 278 x 264 mm  
Net weight: 14.6 Kg



**NEW**



**WTR-20**  
Wireless transmitter and receiver 433MHz

---

Code : B04883      79€<sup>Incl. VAT</sup>



1 x W-2 transmitter  
1 x W-2 receiver  
frequencies: 315MHz and 433MHz



**W-515D**  
Smoke machine 1500W

---

Code : B04842      619€<sup>Incl. VAT</sup>



Heating element: 1500W  
Preheating time: 10 minutes  
Tank: 6 litres  
Output volume: 566 m3/min  
Max. consumption: 10 min/litre at 100%  
Wireless remote included  
Control panel: LCD display  
Management: Volume, Timer  
DMX mode: 1 channel  
Integrated DMX wireless receiver  
Use liquid: **FLG-5**  
Power supply: 230V - 50Hz  
Power consumption: 1500W max.  
Dimensions: 561 x 278 x 186 mm  
Net weight: 14 kg



**W-530D**  
Smoke machine 3000 W

---

Code : B04843      759€<sup>Incl. VAT</sup>



Heating element: 3000W  
Preheating time: 12 minutes  
Tank: 6 litres  
Output volume: 1132 m3/min  
Max. consumption: 6 min/litre at 100%  
Wireless remote included  
Control panel: LCD display  
Management: Volume, Timer  
DMX mode: 1 channel  
Integrated DMX wireless receiver  
Use liquid: **FLG-5**  
Power supply: 230V - 50Hz  
Power consumption: 3000W max.  
Dimensions: 581 x 278 x 186 mm  
Net weight: 14 kg



**Z-3000 II**  
Smoke machine 3000W + remote

---

Code : B04809      739€<sup>Incl. VAT</sup>



Heating element: 3000W  
Preheating time: 12 minutes  
Tank: 6 litres  
Output volume: 1132 m3/min  
Max. consumption: 200 ml/min at 100%  
Detachable control panel:  
Management: Volume, Timer, Manual  
DMX mode: 1 channel  
Use liquid: **FLG-5**  
Power supply: 230V - 50Hz  
Power consumption: 3000W max.  
Dimensions: 581 x 278 x 186 mm  
Net weight: 14 kg



**Z-1500 II**  
Smoke machine 1500W + remote

---

Code : B04808      579€<sup>Incl. VAT</sup>



Heating element: 1500W  
Preheating time: 9.5 minutes  
Tank: 6 litres  
Output volume: 566 m3/min  
Max. consumption: 110 ml/min at 100%  
Detachable control panel:  
Management: Volume, Timer, Manual  
DMX mode: 1 channel  
Use liquid: **FLG-5**  
Power supply: 230V - 50Hz  
Power consumption: 1500W max.  
Dimensions: 688 x 285 x 257 mm  
Net weight: 14 kg

**NEW**



**Z-30PRO-433**  
Wireless control module for Z-1500II / Z-3000II

---

Code : B04827      179€<sup>Incl. VAT</sup>



Heating element: 1500W  
Preheating time: 9.5 minutes  
Tank: 6 litres  
Output volume: 566 m3/min  
Max. consumption: 110 ml/min at 100%  
Detachable control panel:  
Management: Volume, Timer, Manual  
DMX mode: 1 channel  
Use liquid: **FLG-5**  
Power supply: 230V - 50Hz  
Power consumption: 1500W max.  
Dimensions: 688 x 285 x 257 mm  
Net weight: 14 kg



**Z-1200 II**  
Smoke machine 1200W + remote

---

Code : B04807      429€<sup>Incl. VAT</sup>



Heating element: 1200W  
Preheating time: 9.5 minutes  
Tank: 2.5 litres  
Output volume: 510 m3/min  
Max. consumption: 90 ml/min at 100%  
Control panel:  
Management: Volume, Timer, Manual  
DMX mode: 1 channel  
Use liquid: **FLG-5**  
Power supply: 230V - 50Hz  
Power consumption: 1200W max.  
Dimensions: 458 x 243 x 251 mm  
Net weight: 10.9 kg

# EFFECT MACHINES



## Smotec1500

Smoke machine DMX 1500W  
With HF remote and control panel

Code : H9577 649€<sup>Incl. VAT</sup>



Heating element: 1500W  
Preheating time: 8 minutes  
Tank: 10 litres  
Output volume: 566 m3/min  
Max. consumption: 8.6 litres / hour  
RF Remote control: on/off  
Control panel: output interval + volume controls  
DMX channel: 1  
Use liquid:  
Power supply: 230V - 50Hz  
Power consumption: 1600W max.  
Dimensions: 668 x 319 x 170 mm  
Net weight: 15 kg



## Smotec1000

Smoke machine DMX 1000W  
With HF remote and Timer

Code : H9576 379€<sup>Incl. VAT</sup>



Heating element: 1000W  
Preheating time: 12 minutes  
Tank: 2.8 litres  
Output volume: 283m3 / minute  
Max. consumption: 2.5 litres / hour  
RF Remote control: on/off  
Control panel: output interval + volume controls  
DMX channel: 1  
Use liquid:  
Power supply: 230V - 50Hz  
Power consumption: 1100W max.  
Dimensions: 468 x 250 x 148 mm  
Net weight: 11.4 kg



## Smotec800

Smoke machine 800W  
With timer remote

Code : H9575 169€<sup>Incl. VAT</sup>



Heating element: 800W  
Preheating time: 1.5 minutes  
Tank: 0.8 litre  
Output volume: 85m3/minute  
Consumption type: 0.6 litre / hour  
Remote control : With duration and interval setting from 5 to 200 seconds  
Use liquid: HD5L  
Power supply: 230V - 50Hz  
Power consumption: 900W max.  
Dimensions: 315 x 128 x 165.5 mm  
Net weight: 3.5 kg



## FX-1200

Smoke machine - 1200W

Code : B04895 159€<sup>Incl. VAT</sup>



Heating element: 1200W  
Preheating time: 5 minutes  
Tank: 2.5 litre  
Output volume: 510 m3/minute  
Wired and wireless remote included  
Use liquid: FOG LIQUID HI-TECH or FOG LIQUID STD  
Wireless FC-5 remote optional  
Power supply: 230V - 50Hz  
Power consumption: 1200W max.  
Dimensions: 475 x 253 x 200 mm  
Net weight: 6.55 kg



## FX-700

Smoke machine - 700 W

Code : B04818 89€<sup>Incl. VAT</sup>



Heating element: 700W  
Preheating time: 5 minutes  
Tank: 0.8 litres  
Output volume: 70 m3/minute  
Wired remote included  
Use liquid: FOG LIQUID HI-TECH or FOG LIQUID STD  
Wireless FC-5 remote optional  
Power supply: 230V - 50Hz  
Power consumption: 700W max.  
Dimensions: 330 x 160 x 130 mm  
Net weight: 3.65 kg



## FC-5

Wireless remote for FX-700

Code : B04819 51.90€<sup>Incl. VAT</sup>



Wireless remote for F-80Z, FX-700 and FX-100  
The receiver's magnetic housing can be attached to the smoke machine  
Range: ± 30m





### FIRE FOG

Smoke machine equipped with 3 amber LED lights to colour smoke

Code : B04890 49€<sup>Incl. VAT</sup>



### MAGICAN

Fog in a tank

Code : B04833 11.90€<sup>Incl. VAT</sup>



Heating element: 400W  
 Preheating time: 3 minutes  
 Tank: 0.5 litre  
 Output volume: 57 m<sup>3</sup>/minute  
 Max. consumption: 4 ml/min  
 Wired remote included  
 Use liquid: FOG LIQUID HI-TECH or FOG LIQUID STD  
 Power supply: 230V - 50Hz  
 Power consumption: 400W max.  
 Dimensions: 240 x 120 x 163 mm  
 Net weight: 1.81 kg

Very original.  
 Fog in a tank!  
 For use in small rooms  
 Always ready for use  
 Non-toxic, non-irritating, does not damage ozone layer



### M-7 RGBA

Vertical smoke machine with an intense output to simulate CO<sub>2</sub> effects.

Code : B04845 679€<sup>Incl. VAT</sup>



Light source: 22 3W LEDs  
 5 red, 6 green, 6 blue, 5 amber  
 Heating element: 1550W  
 Preheating time: 5 minutes  
 Tank: 2.5 litres  
 Max. consumption: 25 ml/ 10s at 100%  
 Functions with liquid FLC-5  
 HF remote with 4 programmable buttons  
 - Control panel with emission interval, smoke volume and LED management  
 DMX mode: 9 channels  
 Can operate in both vertical and horizontal position  
 Power supply: 230V - 50Hz  
 Power consumption: 1600W max.  
 Dimensions: 340 x 195 x 380 mm  
 Net weight: 10.9 kg



### GeyTEC

Geyser machine with 22 3W LEDs - 1550W

Code : H10202 629€<sup>Incl. VAT</sup>



Light source: 22 3W LEDs  
 8 red, 7 green, 7 blue  
 Heating element: 1550W  
 Preheating time: 5 minutes  
 Tank: 2.5 litres  
 Max. consumption: 25 ml/ 10s at 100%  
 Functions with rapid dissipation liquid CONTEST® FD5L  
 HF remote with 4 programmable buttons  
 - Control panel with emission interval, smoke volume and LED management  
 DMX mode: 8 channels  
 Can operate in both vertical and horizontal position  
 Power supply: 230V - 50Hz  
 Power consumption: 1600W max.  
 Dimensions: 340 x 195 x 380 mm  
 Net weight: 10.9 kg



### FLY-GeyTECx2

Flight case for 2 GeyTEC or 2 M-7 RGBA

Code : H10337 319€<sup>Incl. VAT</sup>



# EFFECT MACHINES



**Z-1020**  
ANTARI Z-1020 smoke machine

Code : B04806      359€<sup>Incl. VAT</sup>



Heating element: 1050W  
Preheating time: 13 minutes  
Tank: 2.4 litres  
Output volume: 453 m3/min  
Max. consumption: 90 ml/min at 100%  
Wired remote included  
Control panel:  
Management: Manual on/off  
DMX mode: 1 channel  
Use liquid: **FLG-5**  
Power supply: 230V - 50Hz  
Power consumption: 1050W max.  
Dimensions: 408 x 295 x 199 mm  
Net weight: 9.8 kg



**COLOR JET**  
Powerful vertical jet smoke machine with 6 3 W RGB LEDs

Code : B04892      199€<sup>Incl. VAT</sup>



Light source: 6x3W RGB LEDs  
Heating element: 900W  
Preheating time: 4 minutes  
Tank: 2.5 litres  
HF remote with 4 programmable buttons  
DMX mode: 4 channels  
Functions with liquid **FLC-5**  
Power supply: 230V - 50Hz  
Power consumption: 950W max.  
Dimensions: 340 x 250 x 130 mm  
Net weight: 5.5 kg



**BUBBLE-01**  
Bubble machine

Code : B04893      39,90€<sup>Incl. VAT</sup>



This machine functions with a special ready to use liquid.  
Use liquid: **BUBBLE LIQUID 5L**  
Power supply: 230V - 50Hz  
Power consumption: 30W max.  
Dimensions: 200 x 240 x 210 mm  
Net weight: 1.57 kg



**YETI**  
A powerful 1200W snow machine

Code : B04894      189€<sup>Incl. VAT</sup>



Snow machine 1200 W  
Produces a large amount of artificial snow flakes.  
Adjustable snow output volume  
Wired remote (included).  
Wireless remote (included).  
Recommended liquid **SNOW LIQUID 5L**  
Power supply: 230V - 50Hz  
Power consumption: 1200W max.  
Dimensions: 530 x 260 x 320 mm  
Net weight: 8.7 kg



**S-500**  
Professional snow machine, controlled by DMX and set up in a flight case.

Code : B04848      1419€<sup>Incl. VAT</sup>



DMX-controlled air volume and liquid flow  
Tank: 20 litres  
Max. consumption: 400 ml/min at 100%  
Effect output equipped with a 10m air hose.  
Control panel: LCD display  
Volume and Timer Mode  
Integrated DMX wireless receiver:  
DMX mode: 2 channels  
Horizontal movement motor PM-1 (120°) optional  
Power supply: 230V - 50Hz  
Power consumption: 890W max.  
Dimensions: 592 x 551 x 651 mm  
Net weight: 37.2 kg



**PM-1**  
Horizontal movement motor for ANTARI S-500 snow machine.

Code : B04849      399€<sup>Incl. VAT</sup>



Horizontal movement motor (120°)  
Compatible with S-500



**BT-HURRICANE**  
DMX high power fan

Code : B04850      479€<sup>Incl. VAT</sup>



Studio and stage fan controlled by DMX  
Power: up to 3500m<sup>3</sup>/h or 58m<sup>3</sup>/min (2060 cfm)  
Sound level:  
30 dB minimum speed - 72 dB maximum speed  
Air flow direction adjustable over 180°  
Continuous adjustment of air flow  
Control options:  
DMX 1 channel (XLR 3&5 pins)  
Wireless DMX (WTR-DMX DONGLE option)  
Manual operation (LED display)  
Power supply: 230V - 50Hz  
Power consumption: 200W max.  
Dimensions: 584 x 476 x 397mm  
Net weight: 16.5 kg



# PERFUMES AND LIQUIDS

SMOKE LIQUID			
Code	Name	Brand	Prix
B04836	FLP-6 - Fog Liquid for FT-100 (fire training) - 6L	ANTARI	59€ <sup>Incl. VAT</sup>
B04838	FLG-5 - Heavy Fog Liquid - 5L (green)	ANTARI	35,90€ <sup>Incl. VAT</sup>
H9656	HD5L - 5L high density smoke liquid drum SM CONTEST	CONTEST	32€ <sup>Incl. VAT</sup>
B04835	F0G LIQUID HI-TECH 1L - Fogger liquid Hi-Tech, 1L	JB SYSTEMS	9,49€ <sup>Incl. VAT</sup>
B04812	F0G LIQUID HI-TECH 5L - Fogger liquid Hi-Tech, 5L	JB SYSTEMS	21,90€ <sup>Incl. VAT</sup>
B04810	F0G LIQUID STD 1L - Fogger liquid standard, 1L	JB SYSTEMS	5,90€ <sup>Incl. VAT</sup>
B04811	F0G LIQUID STD 5L - Fogger liquid standard, 5L	JB SYSTEMS	14,90€ <sup>Incl. VAT</sup>
H10203	FD5L - Fast dissipating geyser machine liquid - 5L	CONTEST	32€ <sup>Incl. VAT</sup>
B04834	FLC-5 - Superfast dissipating Fog for Jet Operation	ANTARI	26,90€ <sup>Incl. VAT</sup>
H10491	MD6L - 6L medium density smoke liquid drum CONTEST	CONTEST	69€ <sup>Incl. VAT</sup>
B04832	HZL-5 - Oil based Haze liquid, 5L	ANTARI	79€ <sup>Incl. VAT</sup>
B04813	SNOW LIQUID 5L - Liquid for Snow machine 5L	JB SYSTEMS	20,90€ <sup>Incl. VAT</sup>
B04831	FOAM LIQUID CC 20L - Concentrated foam liquid 20L	JB SYSTEMS	149€ <sup>Incl. VAT</sup>
B04830	FOAM LIQUID CC 5L - Concentrated foam liquid 5L	JB SYSTEMS	43,90€ <sup>Incl. VAT</sup>
B01911	BUBBLE LIQUID 5L - 5L liquid for bubble machine	JB SYSTEMS	15,90€ <sup>Incl. VAT</sup>
PERFUMES			
H4748	FLAG/MINT - Smoke liquid perfume - Mint	CONTEST	4,50€ <sup>Incl. VAT</sup>
H4749	FLAG/JASMINE - Smoke liquid perfume - Jasmine	CONTEST	4,50€ <sup>Incl. VAT</sup>
H4750	FLAG/FLOWER - Smoke liquid perfume - Orange blossom	CONTEST	4,50€ <sup>Incl. VAT</sup>
H4751	FLAG/APPLE - Smoke liquid perfume - Apple	CONTEST	4,50€ <sup>Incl. VAT</sup>
H4752	FLAG/COCONUT - Smoke liquid perfume - Coconut	CONTEST	4,50€ <sup>Incl. VAT</sup>
H4753	FLAG/VANILLA - Smoke liquid perfume - Vanilla	CONTEST	4,50€ <sup>Incl. VAT</sup>
H4754	FLAG/TROPICAL - Smoke liquid perfume - Tropical	CONTEST	4,50€ <sup>Incl. VAT</sup>
H4755	FLAG/LEMON - Smoke liquid perfume - Lemon	CONTEST	4,50€ <sup>Incl. VAT</sup>
H4756	FLAG/LAVENDER - Smoke liquid perfume - Lavender	CONTEST	4,50€ <sup>Incl. VAT</sup>
H4757	FLAG/STRAWBERRY - Smoke liquid perfume - Strawberry	CONTEST	4,50€ <sup>Incl. VAT</sup>
B04822	Fragrance - Apple - Smoke liquid perfume	JB SYSTEMS	4,79€ <sup>Incl. VAT</sup>
B04820	Fragrance - Coco - Smoke liquid perfume	JB SYSTEMS	4,79€ <sup>Incl. VAT</sup>
B04823	Fragrance - Musk - Smoke liquid perfume	JB SYSTEMS	4,79€ <sup>Incl. VAT</sup>
B04821	Fragrance - Strawberry - Smoke liquid perfume	JB SYSTEMS	4,79€ <sup>Incl. VAT</sup>
B04825	Fragrance - Tutti Frutti - Smoke liquid perfume	JB SYSTEMS	4,79€ <sup>Incl. VAT</sup>

## WARNING

### ONLY USE THE RECOMMENDED SMOKE LIQUIDS FOR YOUR MACHINES.

These liquids are compliant with the latest health and environmental regulations.

These liquids have been specially tested for your machine and guarantee the best possible results.

These are the only liquids that guarantee long term operation, use of other liquids will damage your machine by clogging the heating element and wearing out the pump.

Repairs for clogged heating elements will only be covered after expert evaluation. The warranty will only be valid if the recommended liquid was used.



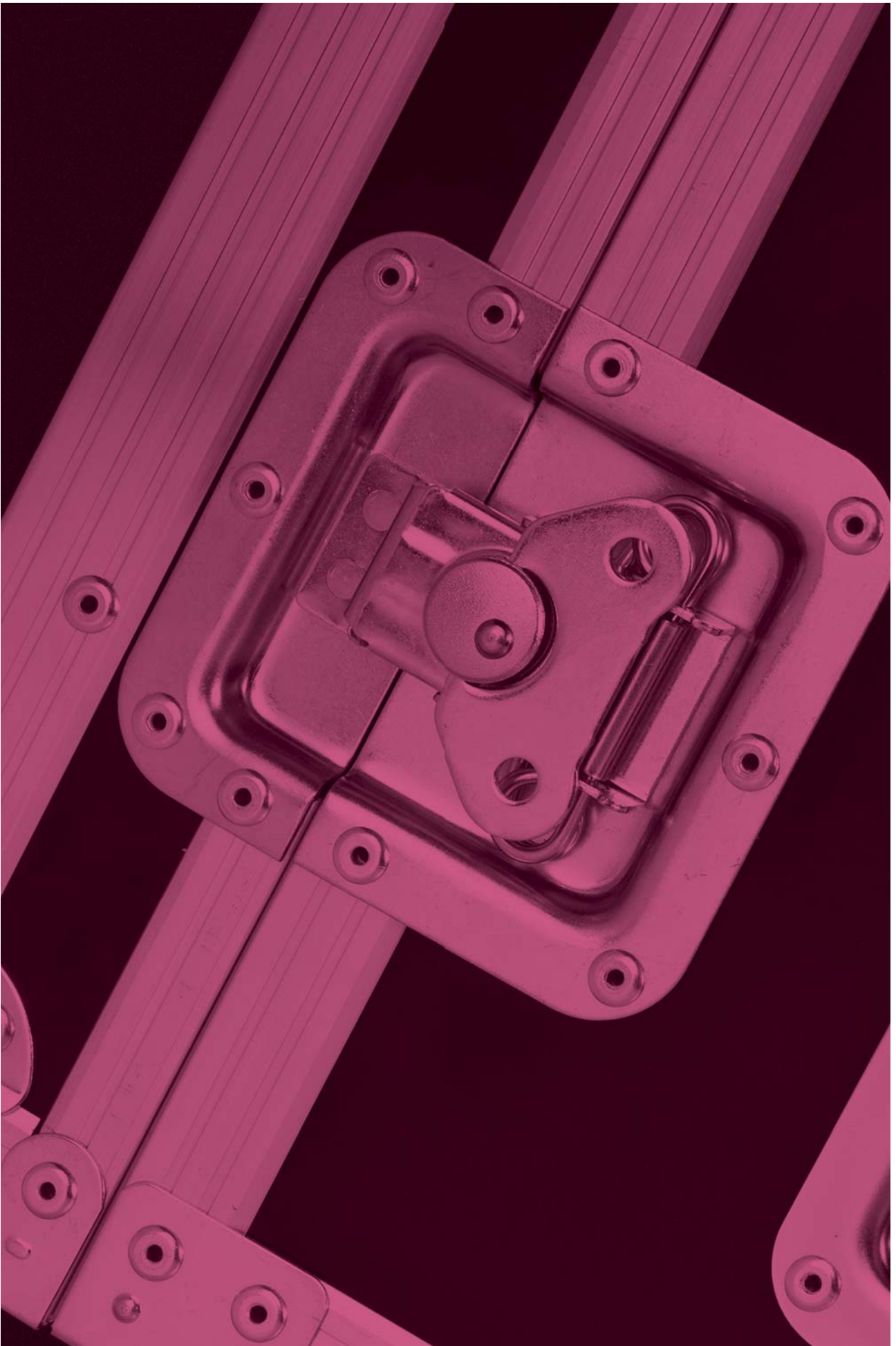

# FLIGHT-CASES

AUDIO FLIGHT-CASES  
FLIGHT-CASES FOR LIGHTS  
19" RACKS



# AUDIO FLIGHT-CASES



**CASE FOR 2x SC-15**  
Flight-case for 2x SC-15.

Code : B03262      669€Incl. VAT



**CASE FOR 2x SC-12**  
Flight-case for 2x SC-12.

Code : B03261      519€Incl. VAT



**CASE FOR 4x SC-08**  
Flight-case for 4x SC-08

Code : B03260      639€Incl. VAT



**CASE FOR 8x SC-05**  
Flight-case for 8x SC-05

Code : B03259      569€Incl. VAT



**RACK CASE 10/18U**  
Convenient and versatile Flight-case.

Code : B03240      419€Incl. VAT



**CARPET DJ MIXER  
CASE 5U+11U**  
Carpeted DJ Flight-case.

Code : B03200      89€Incl. VAT



**TT-CASE**  
High-quality modern flight-case for DJ turntables (T2, T3, X-TRM1, SL1200, etc.).

Code : B03206      59€Incl. VAT



**MICRO CASE 3U**  
Standard 19" Flight-case 3U height, reduced depth 230mm/300mm

Code : B03221      99€Incl. VAT



**CASE FOR  
CONTROLLER+LAPTOP**  
For 19" controller + laptop.

Code : B03231      159€Incl. VAT



**DJ CASE 10/6U**  
Standard 19" Flight-case 6U height + 10U top

Code : B03227      169€Incl. VAT



**PRO 445-4U**  
Standard 19" Flight-case 4U height + 10U top

Code : B03222      159€Incl. VAT



**CONTROLLER CASE 3U**  
Flight-case for small depth 19" controllers, up to 3U [e.g. PCM-1, LM430, Scenemaster, USB900, etc.]

Code : B03224      79€Incl. VAT



# FLIGHT-CASES FOR LIGHTS



**FLY-Beam-Flex15Rx2**  
Flight-case for 2 Evora-Beam/Flex15R

Code : H10343 699€<sup>Incl. VAT</sup>



**CASE FOR 2x BTX-TITAN**  
Flight-case for 2x BTX-TITAN

Code : B03251 579€<sup>Incl. VAT</sup>



**MOVING HEAD CASE 3**  
Flight-case for 4x BTX-SATURN

Code : B03273 729€<sup>Incl. VAT</sup>



**FLY2Fusion180**  
Flight-case for 2x FUSION180

Code : H10737 699€<sup>Incl. VAT</sup>



**CASE FOR 2x BTX-BEAM 5R**  
Flight-case for 2x BTX-BEAM 5R.

Code : B03239 379€<sup>Incl. VAT</sup>



**CASE FOR 4x BTX-BEAM 2R**  
Flight-case for 4x BTX-BEAM 2R

Code : B03248 399€<sup>Incl. VAT</sup>



**FLY-RAY1R-HEZ0120Zx4**  
Flight-case for 4 RAY1R or 4 HEZ0120Z

Code : H10610 599€<sup>Incl. VAT</sup>



**CASE for 4x BT-TRACKER**  
Flight-case for 4x BT-TRACKER.

Code : B03264 429€<sup>Incl. VAT</sup>



**CASE for 6x BEAM FURY-1**  
Flight-case for 6x BEAM FURY-1

Code : B03265 399€<sup>Incl. VAT</sup>



**FLY-DARTx6**  
Flight-case for 6x DART60 or DART60i ZOOM

Code : H10611 429€<sup>Incl. VAT</sup>



**CASE FOR BEAM WIZARD5x5**  
Flight-case for 2x BT-BEAM WIZARD

Code : B03256 579€<sup>Incl. VAT</sup>



**FLY2FLAG25i**  
Flight-case for 2 x FLAG25i

Code : H10428 599€<sup>Incl. VAT</sup>



# FLIGHT-CASES FOR LIGHTS



## FLY2ROTOR7i

Flight-case for 2 x ROTOR7i

Code : H10429

399€<sup>Incl. VAT</sup>

**Contest** 



## CASE FOR 2x BT-DAZZLE

Flight-case for 2 x BT-DAZZLE.

Code : B03258

229€<sup>Incl. VAT</sup>

**JVCase** 



## FLY4Hezo300ZR

Flight-case for 4 x HEZO300ZR

Code : H10736

649€<sup>Incl. VAT</sup>

**Contest** 



## CASE FOR 4x BT- W36L3 / BT-W07L12

For 4x BT-W36L3 / 4x BT-W07L12

Code : B03235

169€<sup>Incl. VAT</sup>

**JVCase** 



## MOVING HEAD CASE2

Flight-case for 4x BT-Orbit/BT-W19L10 ZOOM

Code : B03272

529€<sup>Incl. VAT</sup>

**JVCase** 



## CASE FOR 4x STRIKER

Flight-case for 4x STRIKER

Code : B03267

269€<sup>Incl. VAT</sup>

**JVCase** 



## CASE FOR 4x TORNADO 7

Flight-case for 4x TORNADO 7

Code : B03247

229€<sup>Incl. VAT</sup>

**JVCase** 



## Fly4Ninja-S1

Flight-case for 4 x Ninja-7x15QC

Code : H10076

559€<sup>Incl. VAT</sup>

**Contest** 



## CASE FOR 2x BTX-HAWK

Flight-case for 2x Briteq BTX-HAWK

Code : B03263

469€<sup>Incl. VAT</sup>

**JVCase** 



## FLY2CLUB-S1

Flight-case for Typhoon/Thunder/Cyclone/Wave

Code : H10247

269€<sup>Incl. VAT</sup>

**Contest** 

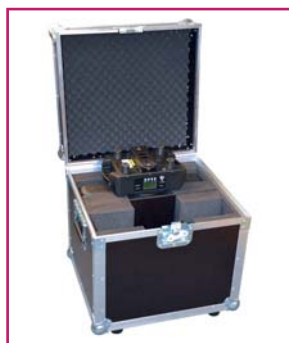

## FLY2CLUB-S2

Flight-case for 2x Storm-8x10

Code : H10248

269€<sup>Incl. VAT</sup>

**Contest** 



## MOVING HEAD CASE1

Flight-case for 2x BT-METEOR, BT-70LS, BT-BEAM70

Code : B03255

219€<sup>Incl. VAT</sup>

**JVCase** 





### LIGHT EFFECT CASE 4

Flight-case for 2x LYNX, 2x BT-20LS, 2x BT-30FC or 2x BT-W12L10 ZOOM

Code : B03225 169€<sup>Incl. VAT</sup>



### LIGHT EFFECT CASE 1

Flight-case for light effects.

Code : B03216 179€<sup>Incl. VAT</sup>



### LIGHT EFFECT CASE 3

Flight-case for light effects (e.g. 2x LED CLUBSCAN OR 2x DYNAMO scan)

Code : B03223 79€<sup>Incl. VAT</sup>



### LIGHT EFFECT CASE 7

Flight-case for The Winner II, Led Victoryscan, Led Spinner

Code : B03233 119€<sup>Incl. VAT</sup>



### PROJECTOR CASE

Flight-case for 4x projectors with clamps

Code : B03253 299€<sup>Incl. VAT</sup>



### PROJECTOR CASE 2

Flight-case for POWERPIXEL8-RGB, POWERPIXEL4-RGB, BEAMBAR10-RGBW, BEAMBAR5-RGBW

Code : B03257 599€<sup>Incl. VAT</sup>



### CASE FOR COB-4BAR

Lightweight and compact case, specially designed to carry a COB-4BAR

Code : B03249 129€<sup>Incl. VAT</sup>



### FLY4Sunbar103

Flight-case for 4x SUNBAR103W

Code : H10738 399€<sup>Incl. VAT</sup>



### FLY-FIRESTORMx2

Flight-case for 2x FIRESTORM

Code : H10339 299€<sup>Incl. VAT</sup>



### FLY-HELIWAVEx2

Flight-case for 2x HELIWAVE

Code : H10340 299€<sup>Incl. VAT</sup>



### FLY-HELIPTIC

Flight-case for 1x HELIPTIC

Code : H10341 249€<sup>Incl. VAT</sup>



### FLY-irLED64x6

Flight-case for 6x PAR64

Code : H10338 429€<sup>Incl. VAT</sup>



# FLIGHT-CASES FOR LIGHTS



## FLY8-irLEDFLAT

Flight-case for 8x FLAT12SIX

Code : H10739

429€<sup>Incl. VAT</sup>

**Contest**



## CASE for 4x COB-PLANO

4x COB-PLANO + LEDCON-02 Mk2

Code : B03252

119€<sup>Incl. VAT</sup>

**JV**

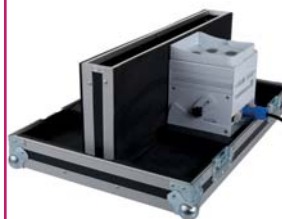

## CASE-2 for 6x ACCU-COLOR

6x ACCU COLOR projectors + accessories

Code : B03268

199€<sup>Incl. VAT</sup>

**JV**



## FLY-IPairx6

Flight-case for 6x IPair5x12Six

Code : H10464

399€<sup>Incl. VAT</sup>

**Contest**



## NEW FLY4IPANEL

Flight-case for 4 IPANEL24x10QC

Code : H10866

559€<sup>Incl. VAT</sup>

**Contest**



## CASE for 2x BT-VINTAGE

Flight-case for 2x BT-VINTAGE

Code : B03271

689€<sup>Incl. VAT</sup>

**JV**



## MATRIX5x5-CASE

Flight-case for 6x MATRIX5x5

Code : B04422

339€<sup>Incl. VAT</sup>

**JV**



## CASE for 6x BT-GLOWPANEL

Flight-case for 6x BT-GLOWPANEL

Code : B03269

379€<sup>Incl. VAT</sup>

**JV**



## CASE for 8x BT-GLOWBAR

Flight-case for 8x BT-GLOWBAR

Code : B03270

459€<sup>Incl. VAT</sup>

**JV**



## FLY-GeyTECx2

Flight-case for 2x GeyTEC

Code : H10337

319€<sup>Incl. VAT</sup>

**Contest**



## FLY-HAZETEC

Flight-case for HAZETEC

Code : H10510

269€<sup>Incl. VAT</sup>

**Contest**



## CABLE CASE

Extra solid Flight-case specially designed to carry cables and other heavy objects.

Code : B03244

599€<sup>Incl. VAT</sup>

**JV**

NEW



### FLY4FRESNEL

For 4 Fresnel 150-250 projectors

Code : H10888

699€<sup>Incl. VAT</sup>



# 19" RACK



### RACK CASE 16U

Standard 19" Flight-case 16U height, castors included

Code : B03211

229€<sup>Incl. VAT</sup>



### RACK CASE 12U

Standard 19" Flight-case 12U height, castors included

Code : B03210

209€<sup>Incl. VAT</sup>



### RACK CASE 8U

Standard 19" Flight-case 8U height

Code : B03209

109€<sup>Incl. VAT</sup>



### RACK CASE 6U

Standard 19" Flight-case 6U height

Code : B03219

99€<sup>Incl. VAT</sup>



### RACK CASE 4U

Standard 19" Flight-case 4U height

Code : B03208

89€<sup>Incl. VAT</sup>



### RACK CASE 2U

Standard 19" Flight-case 2U height

Code : B03212

74.90€<sup>Incl. VAT</sup>



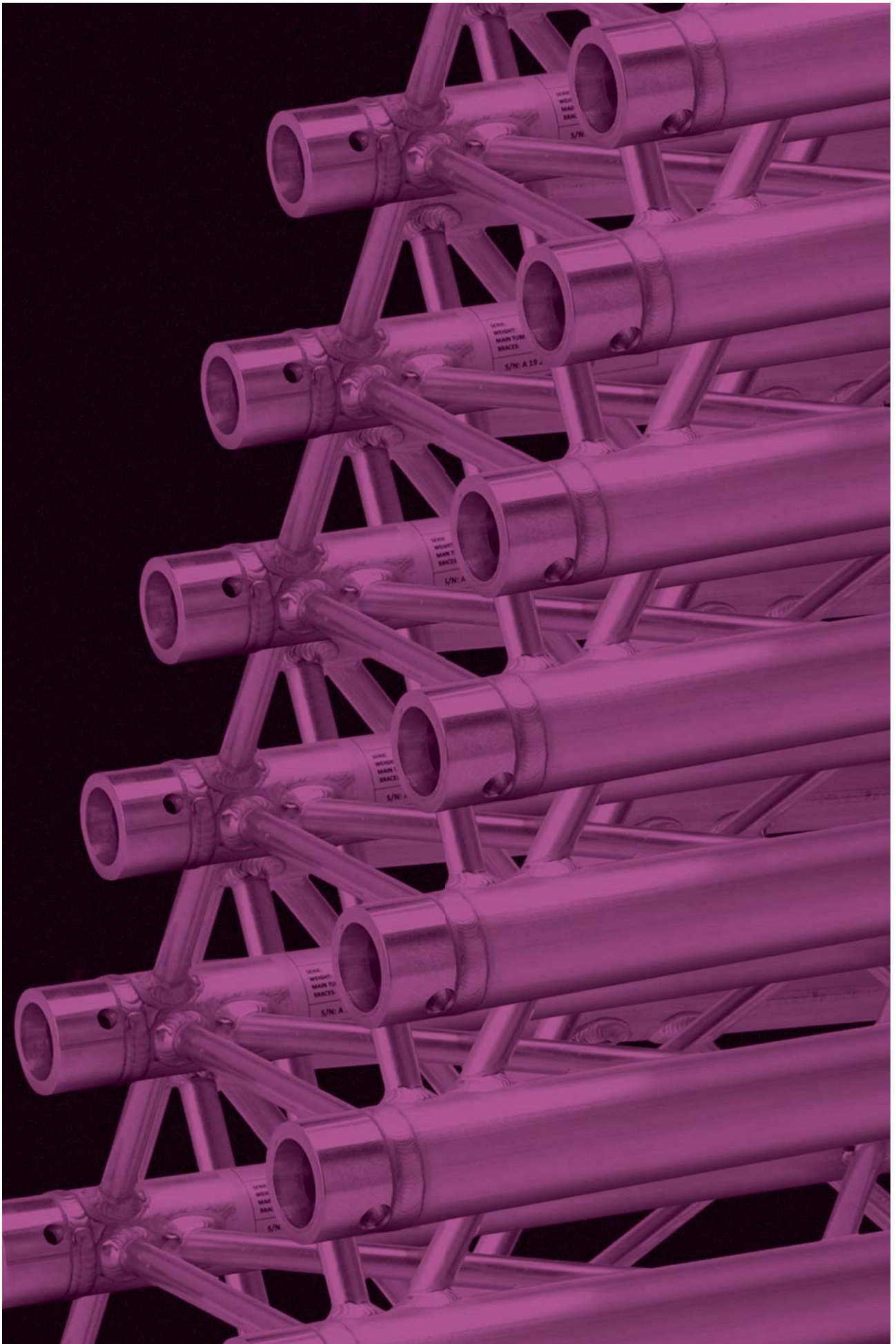

# TRUSSS

QUATRO 290 TRUSS

QUATRO 220 TRUSS

TRIO 290 TRUSS

TRIO 220 TRUSS

TRIO 200 TRUSS

DUO 290 TRUSS

UNO TRUSS

DECO TRUSS

TOTEMS

RIGGING

WINCH STANDS

CABLE CHANNEL

PLATFORMS

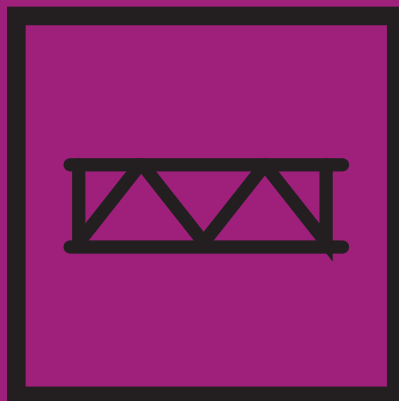

# QUATRO 290 TRUSS



Manufacture according to DIN ISO 4113 and TÜV standards.  
Aluminium alloy truss (EN AW 6082 T6) 50 mm in diameter and 2 mm thick

**50 mm tubes**  
**16 mm braces**  
**Square section with 240 mm spacing between each tube (290 mm exterior)**

**Assembly with conical coupler, spigot pin and Safety R-springs**  
**Section: 290 mm**

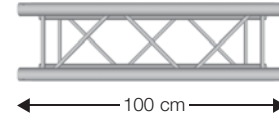
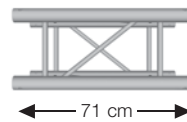
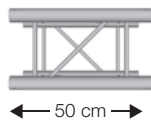
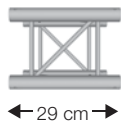

**QUA29-029**  
Square aluminium truss - 290 mm  
Length 29 cm

---

Code : H10118      119€<sup>Incl. VAT</sup>

---

**QUA29-050**  
Square aluminium truss - 290 mm  
Length 50 cm

---

Code : H10049      129€<sup>Incl. VAT</sup>

---

**QUA29-071**  
Quatro aluminium truss - 290 mm  
Length 71 cm

---

Code : H10593      149€<sup>Incl. VAT</sup>

---

**QUA29-100**  
Square aluminium truss - 290 mm  
Length 100 cm

---

Code : H10050      169€<sup>Incl. VAT</sup>

---

**QUA29-200**  
Square aluminium truss - 290 mm  
Length 200 cm

---

Code : H10051      239€<sup>Incl. VAT</sup>

---

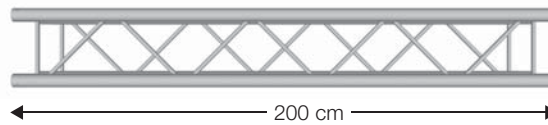

**QUA29-300**  
Square aluminium truss - 290 mm  
Length 300 cm

---

Code : H10052      309€<sup>Incl. VAT</sup>

---

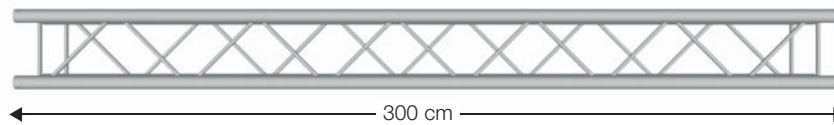

**The CONTEST® truss comes with :**

- 1 connection kit per bar

LENGTH (M)	↔	4	6	8	10	12	14	16
Max centred load (kg)	▼	1177	776.8	574.2	450.8	366.9	305.6	258.5
Deformation (mm)	⌒	12.3	27.9	49.8	78.4	113.8	156.4	206.6
Max distributed load (kg/m)	▼▼▼	449.5	258.9	143.6	90.2	61.2	43.7	32.3
Deformation (mm)	⌒	11.8	34.7	61.7	96.6	139.5	190.4	249.5

The load tables show the weight limits supported between two fixed hook points.  
Centred or distributed loads cannot be added together. Consult a qualified technician.



Manufacture according to DIN ISO 4113 and TÜV standards.  
Aluminium alloy truss (EN AW 6082 T6) 50 mm in diameter and 2 mm thick

**50 mm tubes**  
**16 mm braces**  
**Square section with 240 mm spacing between each tube (290 mm exterior)**

**Assembly with conical coupler, spigot pin and Safety R-springs**  
**Section: 290 mm**

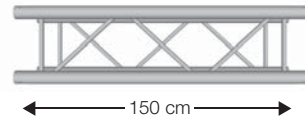
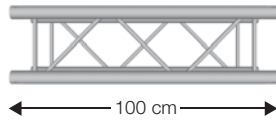
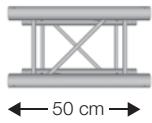

**BT-TRUSS QUAT 29050**

Square aluminium truss - 290 mm  
Length 50 cm

Code : B03650 109€<sup>Incl. VAT</sup>



**BT-TRUSS QUAT 29100**

Square aluminium truss - 290 mm  
Length 100 cm

Code : B03651 149€<sup>Incl. VAT</sup>



**BT-TRUSS QUAT 29150**

Square aluminium truss - 290 mm  
Length 150 cm

Code : B03654 189€<sup>Incl. VAT</sup>



**BT-TRUSS QUAT 29200**

Square aluminium truss - 290 mm  
Length 200 cm

Code : B03652 209€<sup>Incl. VAT</sup>

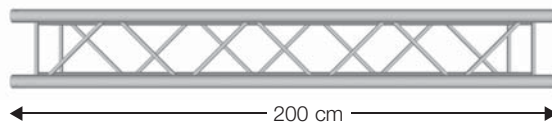

**BT-TRUSS QUAT 29250**

Square aluminium truss - 290 mm  
Length 250 cm

Code : B03657 249€<sup>Incl. VAT</sup>

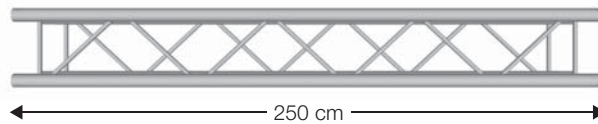

**BT-TRUSS QUAT 29300**

Square aluminium truss - 290 mm  
Length 300 cm

Code : B03653 289€<sup>Incl. VAT</sup>

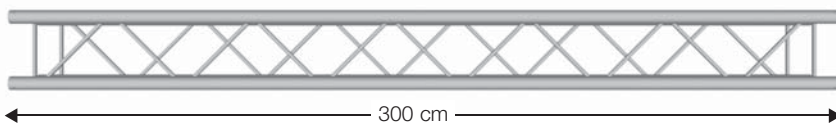

**The BRITEQ® truss is delivered WITHOUT the connection kit**

LENGTH (M)	↔	4	6	8	10	12	14	16
Max centred load (kg)	▼	1177	776.8	574.2	450.8	366.9	305.6	258.5
Deformation (mm)	⤵	12.3	27.9	49.8	78.4	113.8	156.4	206.6
Max distributed load (kg/m)	▼▼▼	449.5	258.9	143.6	90.2	61.2	43.7	32.3
Deformation (mm)	⤵	11.8	34.7	61.7	96.6	139.5	190.4	249.5

The load tables show the weight limits supported between two fixed hook points.  
Centred or distributed loads cannot be added together. Consult a qualified technician.



# QUATRO 290 TRUSS

- The CONTEST® truss comes with :
- 1 x connection kit, angle – 2 directions
  - 2 x connection kits, angle – 3, 4 and 5 directions

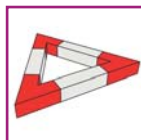
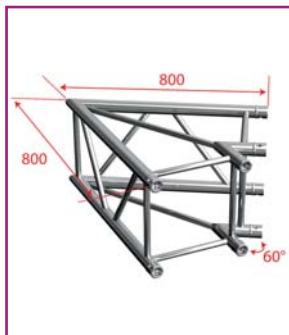

## AGQUA-01

Quatro angle - 80 cm 60° - 2 directions

Code : H10053

199€<sup>Incl. VAT</sup>

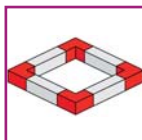
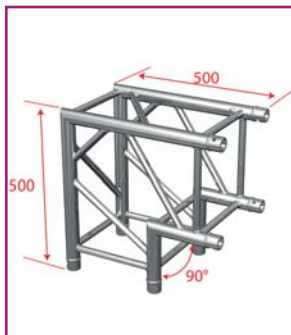

## AGQUA-02

Quatro angle - 50 cm 90° - 2 directions

Code : H10054

179€<sup>Incl. VAT</sup>

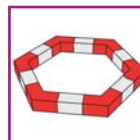
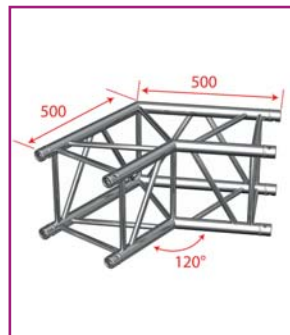

## AGQUA-03

Quatro angle - 50 cm 120° - 2 directions

Code : H10055

179€<sup>Incl. VAT</sup>

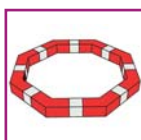
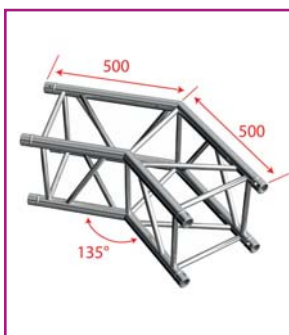

## AGQUA-04

Quatro angle - 50 cm 135° - 2 directions

Code : H10056

179€<sup>Incl. VAT</sup>

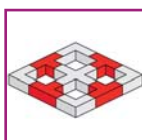
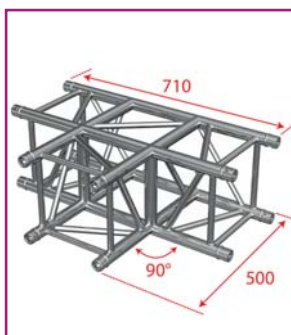

## AGQUA-05

Quatro angle - 90° - 3 directions

Code : H10057

269€<sup>Incl. VAT</sup>

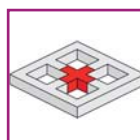
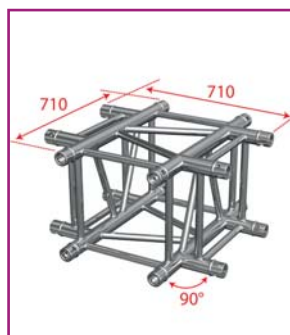

## AGQUA-06

Quatro angle - 90° - 4 directions

Code : H10058

349€<sup>Incl. VAT</sup>

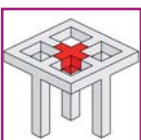

## AGQUA-07

Quatro angle - 90° - 5 directions

Code : H10059

399€<sup>Incl. VAT</sup>

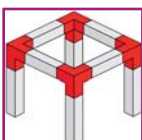

## AGQUA-09

Quatro side piece - 3 directions

Code : H10061

269€<sup>Incl. VAT</sup>

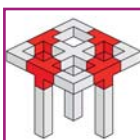

## AGQUA-10

Quatro side piece - 4 directions

Code : H10062

349€<sup>Incl. VAT</sup>





The BRITeQ® truss is delivered WITHOUT the connection kit

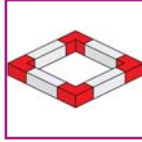

**BT-TRUSS QUAT 29 - A003**  
Quatro angle - 90° - 2 directions

Code : B03660 169€<sup>Incl. VAT</sup>

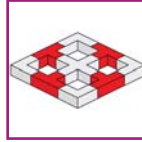
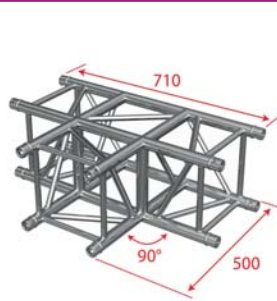

**BT-TRUSS QUAT 29 - A017**  
Quatro angle - 90° - 3 directions

Code : B03666 249€<sup>Incl. VAT</sup>

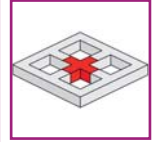
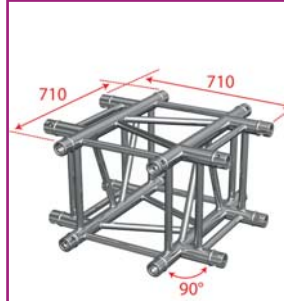

**BT-TRUSS QUAT 29 - A016**  
Quatro angle - 90° - 4 directions

Code : B03667 349€<sup>Incl. VAT</sup>

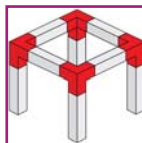

**BT-TRUSS QUAT 29 - A012**  
Quatro side piece - 3 directions

Code : B03665 249€<sup>Incl. VAT</sup>

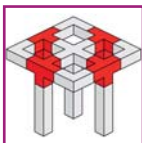

**BT-TRUSS QUAT 29 - A020**  
Quatro side piece - 4 directions

Code : B03668 349€<sup>Incl. VAT</sup>

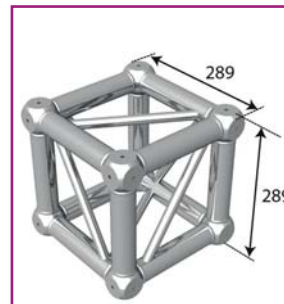

**AGCUB290**  
Connection cube for 290 mm square truss

Code : H10433 359€<sup>Incl. VAT</sup>

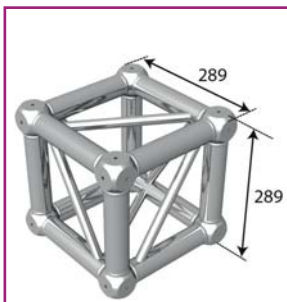

**BT-TRUSS QUAT 29 - BOX CORNER**  
Connection cube for 290 mm square truss

Code : B03670 359€<sup>Incl. VAT</sup>



**BT-TRUSS QUAT 29 - BOX Coupler Set (4 pcs)**  
4 sets of couplers for BT-TRUSS QUAT 29 - BOX CORNER.

Code : B03671 27,90€<sup>Incl. VAT</sup>

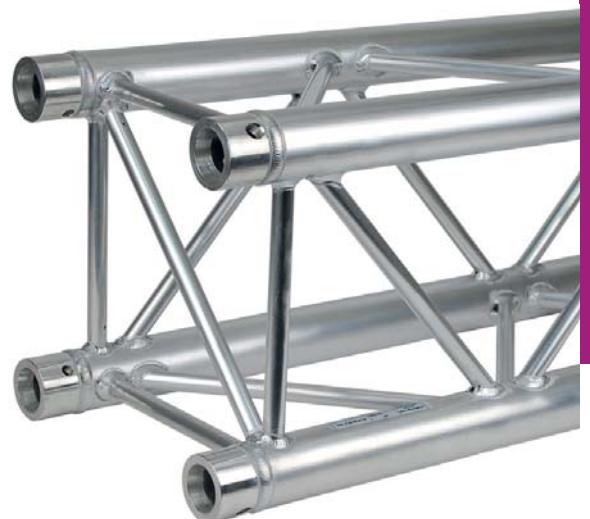

# QUATRO 290 TRUSS



Manufacture according to DIN ISO 4113 and TÜV standards.  
Aluminium alloy truss (EN AW 6082 T6) 50 mm in diameter and 2 mm thick

**Attention: we provide the circles on demand. 60 days lead time.**



## BT-TRUSS QUAT 29 - CIRCLE 2M

Quatro 290 truss, circle D=2m, 2 parts

Code : B03690 1499€<sup>Incl. VAT</sup>



## BT-TRUSS QUAT 29 - CIRCLE 3M

Quatro 290 truss, circle D=3m, 2 parts

Code : B03691 1999€<sup>Incl. VAT</sup>



## BT-TRUSS QUAT 29 - CIRCLE 4M

Quatro 290 truss, circle D=4m, 4 parts

Code : B03692 2490€<sup>Incl. VAT</sup>



## BT-TRUSS QUAT 29 - CIRCLE 5M

Quatro 290 truss, circle D=5m, 4 parts

Code : B03693 3299€<sup>Incl. VAT</sup>



## BT-TRUSS QUAT 29 - CIRCLE 6M

Quatro 290 truss, circle D=6m, 6 parts

Code : B03694 3999€<sup>Incl. VAT</sup>



**The BRITEQ truss is delivered WITHOUT the connection set**





**BT-TRUSS 29-TROLLEY-BASE**

Trolley + wheels for 290 mm truss

Code : B03495 83€<sup>Incl. VAT</sup>



**BT-TRUSS 29-TROLLEY-STACK**

Stacking support for 290 mm

Code : B03496 9.90€<sup>Incl. VAT</sup>

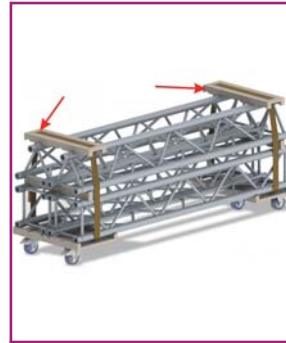

**BT-TRUSS 29-TROLLEY-TOP**

Trolley beams for 290 mm

Code : B03497 25.90€<sup>Incl. VAT</sup>



**EMQUA-B1**

Quatro aluminium baseplate withcouplers, keys and pins. 290x290 mm

Code : H10064 75€<sup>Incl. VAT</sup>



**BT-TRUSS QUAT 29 - BASEPLATE**

Quatro baseplate + half-couplers

Code : B03680 65.90€<sup>Incl. VAT</sup>



**BT-TRUSS Q/T 29 BASE80**

41 Kg heavy baseplate for Trio/Quat 290 with half-couplers, 800 x 800 mm

Code : B03684 249€<sup>Incl. VAT</sup>



**EM29BLOU40D90**

40 kg heavy baseplate for TRIO/QUATRO 290 of 90 cm diam

Code : H10835 369€<sup>Incl. VAT</sup>



**EM29BLOU29D74**

40 kg heavy baseplate for TRIO/QUATRO 290 of 74 cm diam - 29kg

Code : H10463 329€<sup>Incl. VAT</sup>



**MCQUA-KIT**

Set of 4 conical couplers, 8 spigot pins and 8 Safety R-springs

Code : H10063 39€<sup>Incl. VAT</sup>



**BT-TRUSS QUAT 29 - COUPLER SET**

ALU TRUSS Quatro 290 coupler set (4pcs)

Code : B03681 27.90€<sup>Incl. VAT</sup>



**BT-TRUSS QUAT/TRIO 29 - SPIGOT + THREAD**

Quatro/Trio 290 Spigot with thread (1pc)

Code : B03682 2.90€<sup>Incl. VAT</sup>



# QUATRO 220 TRUSS



Manufacture according to DIN ISO 4113 and TÜV standards.  
Aluminium alloy truss (EN AW 6082 T6) 50 mm in diameter and 2 mm thick

**35 mm tubes**  
**8 mm braces**  
**Square section with 185 mm spacing between each tube (220 mm exterior)**

**Assembly with conical coupler, spigot pin and Safety R-springs**  
**Section: 220 mm**

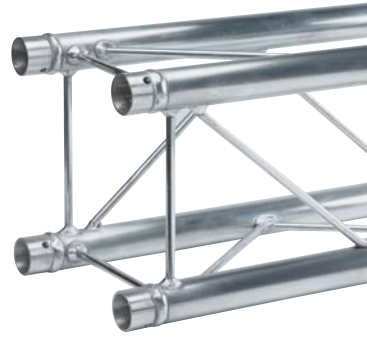

## DECO22Q-PT50

Square aluminium truss - 220 mm  
Length 50 cm

Code : H10218

89€<sup>Incl. VAT</sup>

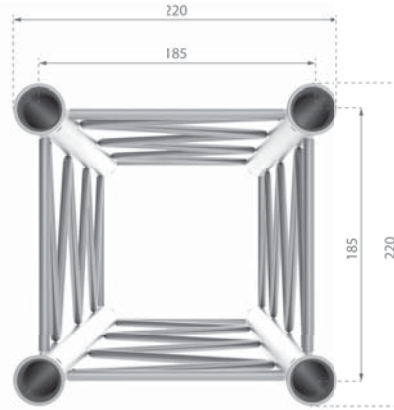
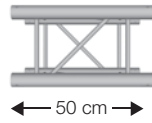

## DECO22Q-PT100

Square aluminium truss - 220 mm  
Length 100 cm

Code : H10219

129€<sup>Incl. VAT</sup>

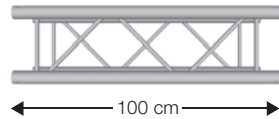

## DECO22Q-PT200

Square aluminium truss - 220 mm  
Length 200 cm

Code : H10220

189€<sup>Incl. VAT</sup>

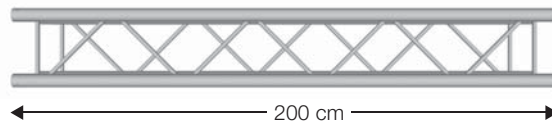

**The CONTEST® truss comes with :**  
• 1 coupler set per bar

LENGTH (M)		2	3	4	5	6
Max centred load (kg)		439.1	334.6	248.5	196.4	161.1
Deformation (mm)		1.9	4.9	8.7	13.7	19.8
Max distributed load (kg/m)		219.5	145.4	108.4	78.5	53.7
Deformation (mm)		1.2	4	9.5	16.9	24.4

The load tables show the weight limits supported between two fixed hook points.  
Centred or distributed loads cannot be added together. Consult a qualified technician.



Manufacture according to DIN ISO 4113 and TÜV standards.  
Aluminium alloy truss (EN AW 6082 T6) 50 mm in diameter and 2 mm thick

**35 mm tubes  
8 mm braces  
Square section with 185 mm spacing between each tube  
(220 mm exterior)**

**Assembly with conical coupler, spigot pin and Safety R-springs  
Section: 220 mm**

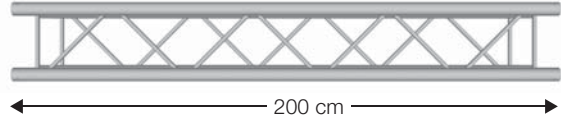
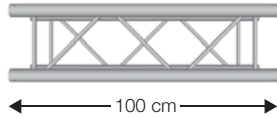
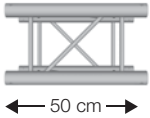

**BT-TRUSS QUAT 22050**  
Square aluminium truss - 220 mm  
Length 50 cm

---

Code : B03550      75€<sup>Incl. VAT</sup>

---

**BT-TRUSS QUAT 22100**  
Square aluminium truss - 220 mm  
Length 100 cm

---

Code : B03551      125€<sup>Incl. VAT</sup>

---

**BT-TRUSS QUAT 22200**  
Square aluminium truss - 220 mm  
Length 200 cm

---

Code : B03552      179€<sup>Incl. VAT</sup>

---

**BT-TRUSS QUAT 22300**  
Square aluminium truss - 220 mm  
Length 300 cm

---

Code : B03553      229€<sup>Incl. VAT</sup>

---

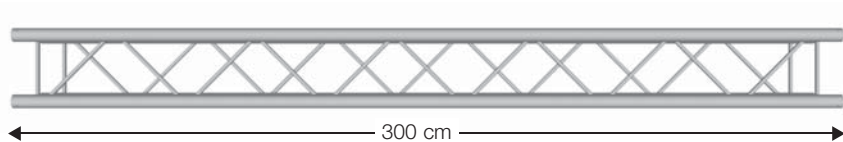

ALU TRUSS Quatro 220 L= 3,00M

**The BRITEQ® truss is delivered WITHOUT the connection kit**

LENGTH (M)		2	3	4	5	6
Max centred load (kg)		439.1	334.6	248.5	196.4	161.1
Deformation (mm)		1.9	4.9	8.7	13.7	19.8
Max distributed load (kg/m)		219.5	145.4	108.4	78.5	53.7
Deformation (mm)		1.2	4	9.5	16.9	24.4

The load tables show the weight limits supported between two fixed hook points.  
Centred or distributed loads cannot be added together. Consult a qualified technician.



# QUATRO 220 TRUSS

The CONTEST® truss comes with :

- 1 x connection kit, angle – 2 directions
- 2 x connection kits - 3, 4 directions

The BRITEQ® truss is delivered WITHOUT the connection kit

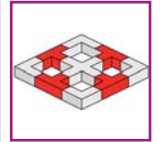
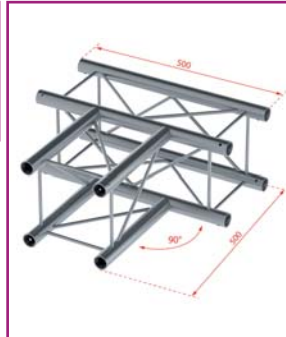
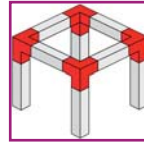
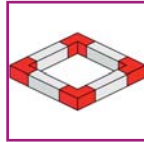

## DEC022Q-AG01

Quatro 220 angle - 50 cm 90° - 2 directions

Code : H10221

159€Incl. VAT



## DEC022Q-AG02

Quatro 220 side piece - 50 cm 90° - 3 directions

Code : H10222

199€Incl. VAT



## DEC022Q-AG03

Quatro 220 angle - 90° - 3 directions

Code : H10223

179€Incl. VAT

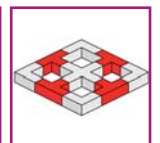
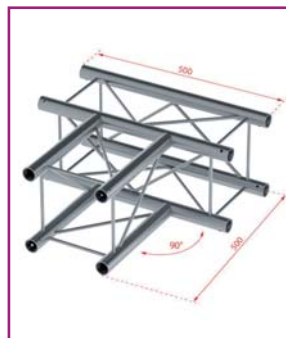
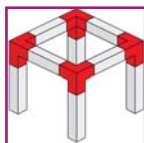
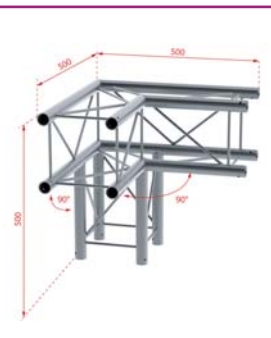
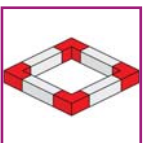
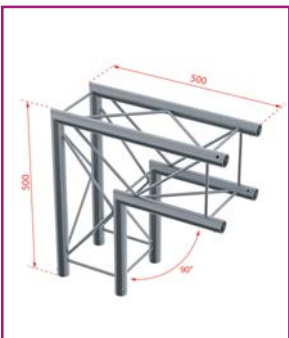

## BT-TRUSS QUAT 22 - A003

Quatro 220 angle - 50 cm 90° - 2 directions  
50 cm 90°

Code : B03560

149€Incl. VAT



## BT-TRUSS QUAT 22 - A012

Quatro 220 side piece - 50 cm 90° - 3 directions

Code : B03565

169€Incl. VAT



## BT-TRUSS QUAT 22 - A017

Quatro 220 angle - 90° - 3 directions

Code : B03566

159€Incl. VAT



## BT-TRUSS QUAT 22 - A016

Quatro 220 cross piece - 4 directions

Code : B03567

279€Incl. VAT



## BT-TRUSS QUAT 22 - A020

Quatro side piece - 4 directions

Code : B03568

249€Incl. VAT





**DEC022Q-EM-B1**

Quatro 220 aluminium baseplate with coupler kit

Code : H10225 55€<sup>Incl. VAT</sup>

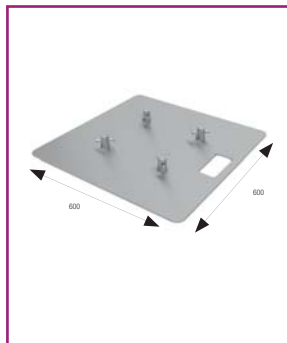

**DEC022-EMB-B3**

Aluminium baseplate 600x600 mm for DEC022T and DEC022Q with coupler kit

Code : H10606 99€<sup>Incl. VAT</sup>



**DEC022Q-MC-KIT**

Kit of 4 couplers, 8 spigot pins and 8 Safety R-springs

Code : H10224 35€<sup>Incl. VAT</sup>



**DEC022-MANCH**

Conical coupler for Deco series aluminium truss

Code : H10226 4.50€<sup>Incl. VAT</sup>



**DEC022-1/2MANCH**

1/2 conical coupler screw M8 for tube of 35

Code : H10332 6€<sup>Incl. VAT</sup>



**DEC022-CLAV**

Spigot pin for conical coupler DEC022 series by unit

Code : H10227 2.50€<sup>Incl. VAT</sup>



**DEC022-GOUP**

Safety R-spring for spigot pin for Deco series

Code : H10228 0.60€<sup>Incl. VAT</sup>



**BT-TRUSS QUAT 22 - COUPLER SET**

ALU TRUSS Quatro 220 Coupler Set (4pcs)

Code : B03581 21.90€<sup>Incl. VAT</sup>



# TRIO 290 TRUSS



Manufacture according to DIN ISO 4113 and TÜV standards.  
Aluminium alloy truss [EN AW 6082 T6] 50 mm in diameter and 2 mm thick.

**50 mm tubes**  
**16 mm braces**  
**Triangular section with 240 mm spacing between each tube (290 mm exterior)**

**Assembly with conical coupler, spigot pin and Safety R-springs**  
**Average weight per metre: 4.5 kg**  
**Section: 290 mm**

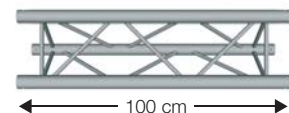
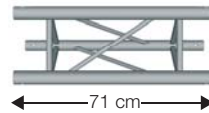
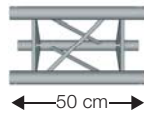
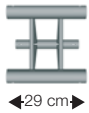

**PT29-029**  
Aluminium truss - 290 mm  
Length 29 cm

---

Code : H4213      89€<sup>Incl. VAT</sup>

---

**PT29-050**  
Aluminium truss - 290 mm  
Length 50 cm

---

Code : H3247      99€<sup>Incl. VAT</sup>

---

**PT29-071**  
Trio aluminium truss - 290 mm  
Length 71 cm

---

Code : H10592      109€<sup>Incl. VAT</sup>

---

**PT29-100**  
Aluminium truss - 290 mm  
Length 100 cm

---

Code : H3248      119€<sup>Incl. VAT</sup>

---

**PT29-200**  
Aluminium truss - 290 mm  
Length 200 cm

---

Code : H3249      179€<sup>Incl. VAT</sup>

---

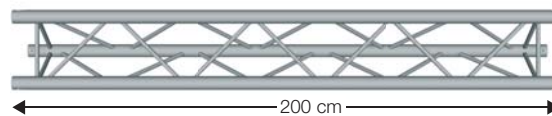

**PT29-300**  
Aluminium truss - 290 mm  
Length 300 cm

---

Code : H3250      229€<sup>Incl. VAT</sup>

---

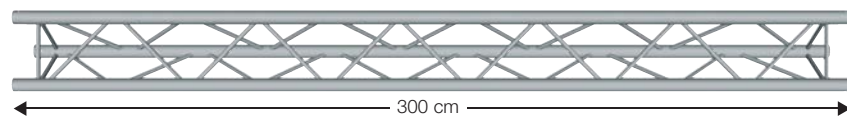

**The CONTEST® truss comes with :**  
• 1 connection kit per bar

LENGTH (M)		2	4	6	8	10	12
Max centred load (kg)		1023.9	506.4	331.5	242.2	187.2	149.2
Deformation (mm)		2.6	10.6	24	43.1	68.2	99.6
Max distributed load (kg/m)		783.1	253.2	110.5	60.6	37.4	24.9
Deformation (mm)		2.5	13.2	29.8	53	83.2	120.3

The load tables show the weight limits supported between two fixed hook points.  
Centred or distributed loads cannot be added together. Consult a qualified technician.



**50 mm tubes**  
**16 mm braces**  
**Triangular section with**  
**240 mm spacing between each**  
**tube (290 mm exterior)**

**Assembly with conical coupler,**  
**spigot pin and Safety R-springs**  
**Average weight per metre:**  
**4.5 kg**  
**Section: 290 mm**



Manufacture according to DIN ISO 4113 and TÜV standards.  
 Aluminium alloy truss (EN AW 6082 T6) 50 mm in diameter and 2 mm thick.

**BT-TRUSS TRIO 29050**

Aluminium truss - 290 mm  
 Length 50 cm

Code : B03600 79€<sup>Incl. VAT</sup>

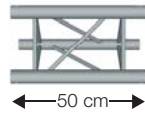

**BT-TRUSS TRIO 29100**

Aluminium truss - 290 mm  
 Length 100 cm

Code : B03601 109€<sup>Incl. VAT</sup>

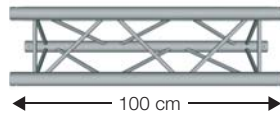

**BT-TRUSS TRIO 29200**

Aluminium truss - 290 mm  
 Length 200 cm

Code : B03602 159€<sup>Incl. VAT</sup>

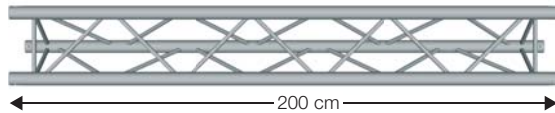

**The BRITEQ® truss is delivered WITHOUT the connection kit**

**BT-TRUSS TRIO 29300**

Aluminium truss - 290 mm  
 Length 300 cm

Code : B03603 209€<sup>Incl. VAT</sup>

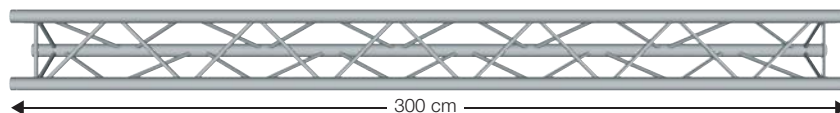

LENGTH (M)		2	4	6	8	10	12
Max centred load (kg)		1023.9	506.4	331.5	242.2	187.2	149.2
Deformation (mm)		2.6	10.6	24	43.1	68.2	99.6
Max distributed load (kg/m)		783.1	253.2	110.5	60.6	37.4	24.9
Deformation (mm)		2.5	13.2	29.8	53	83.2	120.3

The load tables show the weight limits supported between two fixed hook points.  
 Centred or distributed loads cannot be added together. Consult a qualified technician.



# TRIO 290 TRUSS

- The CONTEST® truss comes with :
- 1 x connection kit, angle – 2 directions
  - 2 x connection kits, angle – 3, 4 and 5 directions

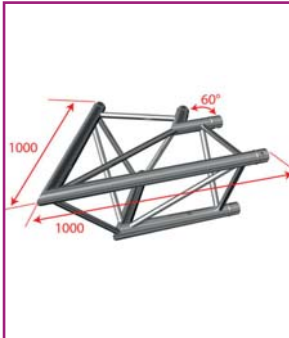

**AG29-020**

Angle - 290 mm 60° - 2 directions -

Code : H7015

159€<sup>Incl. VAT</sup>



**AG29-021**

Angle - 290 mm 90° - 2 directions -

Code : H3251

129€<sup>Incl. VAT</sup>

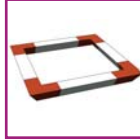

**AG29-022**

Angle - 290 mm 120° - 2 directions -

Code : H7016

129€<sup>Incl. VAT</sup>



**AG29-023**

Angle - 290 mm 135° - 2 directions -

Code : H3252

129€<sup>Incl. VAT</sup>



**AG29-025**

Angle - 290 mm 90° - 2 directions -  
Inner vertex

Code : H3253

129€<sup>Incl. VAT</sup>



**AG29-033**

Angle - 290 mm 90° - 3 directions - Lower  
upright vertex

Code : H3254

209€<sup>Incl. VAT</sup>



**AG29-034**

Angle - 290 mm 90° - 3 directions -  
Lower left-hand vertex

Code : H3255

209€<sup>Incl. VAT</sup>



**AG29-035**

Vertical tee - 290 mm - 3 directions - Lower  
vertex

Code : H3256

209€<sup>Incl. VAT</sup>



**AG29-036**

Horizontal tee - 290 mm 90° - 3 directions

Code : H3257

209€<sup>Incl. VAT</sup>



The BRITEQ® truss is delivered WITHOUT the connection kit

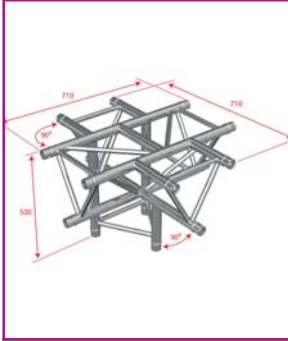
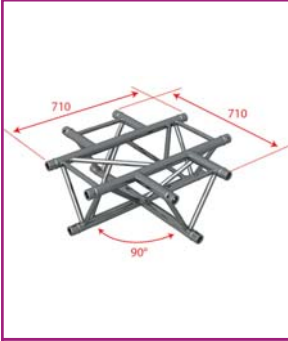

**AG29-041**  
Cross - 290 mm - 4 directions

---

Code : H3258      249€<sup>Incl. VAT</sup>

---

**AG29-042**  
Tee - 290 mm - 4 directions - Apex down

---

Code : H3259      249€<sup>Incl. VAT</sup>

---

**AG29-053**  
Cross - 290 mm - 4 directions plus base

---

Code : H4212      369€<sup>Incl. VAT</sup>

---



**BT-TRUSS TRIO 29 - A003**  
Angle - 290 mm 90° - 2 directions -

---

Code : B03610      114,90€<sup>Incl. VAT</sup>

---

**BT-TRUSS TRIO 29 - A007**  
Angle - 290 mm 90° - 2 directions - Apex down

---

Code : B03611      119€<sup>Incl. VAT</sup>

---

**BT-TRUSS TRIO 29 - A013**  
Angle - 290 mm 90° - 3 directions - Apex down, right

---

Code : B03616      169€<sup>Incl. VAT</sup>

---

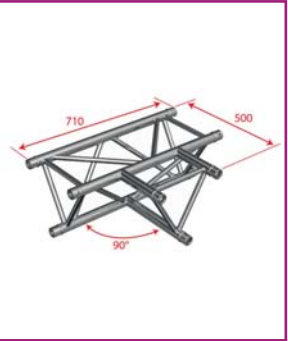

**BT-TRUSS TRIO 29 - A012**  
Angle - 290 mm 90° - 3 directions - Apex down, left

---

Code : B03615      169€<sup>Incl. VAT</sup>

---

**BT-TRUSS TRIO 29 - A018**  
Vertical tee - 290 mm - 3 directions - Apex down

---

Code : B03618      175€<sup>Incl. VAT</sup>

---

**BT-TRUSS TRIO 29 - A017**  
Horizontal tee - 290 mm 90° - 3 directions

---

Code : B03617      179€<sup>Incl. VAT</sup>

---



# TRIO 290 TRUSS

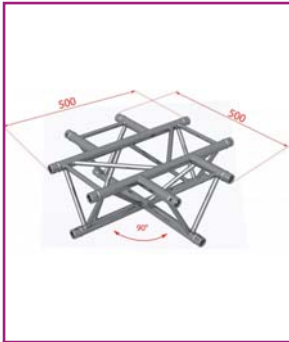

## BT-TRUSS TRIO 29 - A016

Cross - 290 mm - 4 directions

Code : B03619

219€<sup>Incl. VAT</sup>

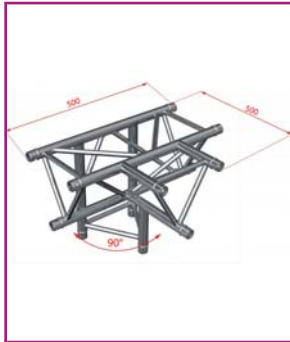
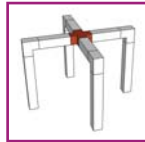

## BT-TRUSS TRIO 29 - A020

Tee - 290 mm - 4 directions - Apex down

Code : B03620

219€<sup>Incl. VAT</sup>

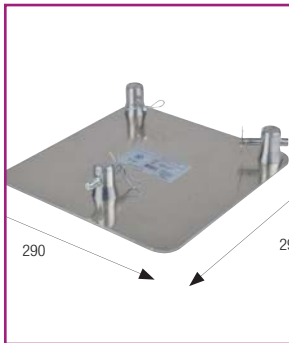

## EM29-B3

Triangular truss baseplate - 290 mm with conical couplers, spigot pins and Safety R-springs

Code : H8884

59€<sup>Incl. VAT</sup>



## EM29-B3T

Light triangular baseplate for PT29

Code : H10833

43€<sup>Incl. VAT</sup>



## MC29-KIT

Set of 3 conical couplers, 6 spigot pins and 6 Safety R-springs

Code : H3261

29€<sup>Incl. VAT</sup>

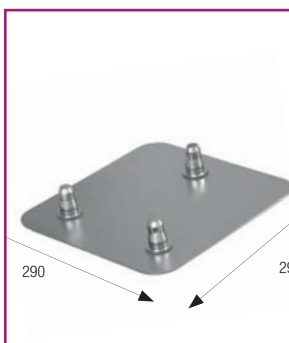

## BT-TRUSS TRIO 29 - BASEPLATE

290 mm baseplate with half-couplers

Code : B03630

59€<sup>Incl. VAT</sup>



## BT-TRUSS TRIO 29 - COUPLER SET

Set of 3 conical couplers, 6 spigot pins and 6 Safety R-springs

Code : B03631

20.9€<sup>Incl. VAT</sup>



## EM29BLOU29D74

40 kg heavy baseplate for TRIO/QUATRO 290 of 74 cm diam - 29kg

Code : H10835

369€<sup>Incl. VAT</sup>



## EM29BLOU29D74

40 kg heavy baseplate for TRIO/QUATRO 290 of 74 cm diam - 29kg

Code : H10463

329€<sup>Incl. VAT</sup>





**BT-TRUSS TRIO 29 - CIRCLE 2M**

Trio 290, circle D=2m, apex up, 2 parts

Code : B03640 999€<sup>Incl. VAT</sup>



**BT-TRUSS TRIO 29 - CIRCLE 3M**

Trio 290, circle D=3m, apex up, 2 parts

Code : B03641 1399€<sup>Incl. VAT</sup>



**BT-TRUSS TRIO 29 - CIRCLE 4M**

Trio 290, circle D=4m, apex up, 4 parts

Code : B03642 1790€<sup>Incl. VAT</sup>



**BT-TRUSS TRIO 29 - CIRCLE 5M**

Trio 290, circle D=5m, apex up, 4 parts

Code : B03643 2450€<sup>Incl. VAT</sup>



**BT-TRUSS TRIO 29 - CIRCLE 6M**

Trio 290, circle D=6m, apex up, 6 parts

Code : B03644 2690€<sup>Incl. VAT</sup>



Manufacture according to DIN ISO 4113 and TÜV standards. Aluminium alloy truss (EN AW 6082 T6) 50 mm in diameter and 2 mm thick.

**Attention: we provide the circles on demand. 60 days lead time.**

**The BRITEQ® truss is delivered WITHOUT the connection kit**



# TRIO 220 TRUSS



Manufacture according to DIN ISO 4113 and TÜV standards.  
Aluminium alloy truss (EN AW 6082 T6)  
50 mm in diameter and 2 mm thick.

**35 mm tubes**  
**8 mm braces**  
**Triangular section with**  
**185 mm spacing between each**  
**tube (220 mm exterior)**

**Assembly with conical coupler,**  
**spigot pin and Safety R-springs**  
**Section: 220 mm**

**DEC022T-PT50**  
Triangular aluminium truss - 20 mm  
Length 50 cm

---

Code : H10229      65€<sup>Incl. VAT</sup>

---

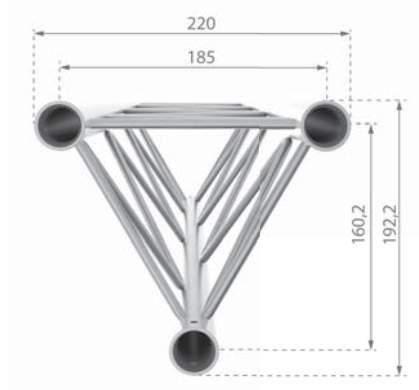
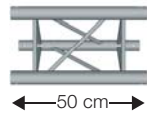

**DEC022T-PT100**  
Triangular aluminium truss - 220 mm  
Length 100 cm

---

Code : H10230      95€<sup>Incl. VAT</sup>

---

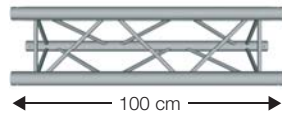

**DEC022T-PT200**  
Triangular aluminium truss - 220 mm  
Length 200 cm

---

Code : H10231      129€<sup>Incl. VAT</sup>

---

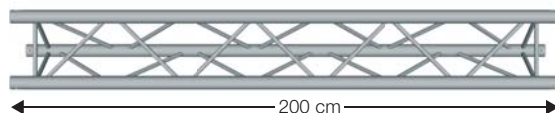

**The CONTEST® truss comes with :**

- 1 connection kit per bar
- 1 x connection kit, angle - 2 directions
- 2 x connection kits, angle - 3 and 4 directions

LENGTH (M)	↔	2	3	4	5	6
Max centred load (kg)	▼	217.7	143.2	105.4	82.3	66.4
Deformation (mm)	▼	1.9	4.2	7.5	11.9	17.3
Max distributed load (kg/m)	▼▼▼	190.2	95.5	52.7	32.9	22.1
Deformation (mm)	▼	2	5.2	9.3	14.6	21.1

The load tables show the weight limits supported between two fixed hook points.  
Centred or distributed loads cannot be added together. Consult a qualified technician.

**35 mm tubes  
8 mm braces  
Triangular section with  
185 mm spacing between each  
tube (220 mm exterior)**

**Assembly with conical coupler,  
spigot pin and Safety R-springs  
Section: 220 mm**

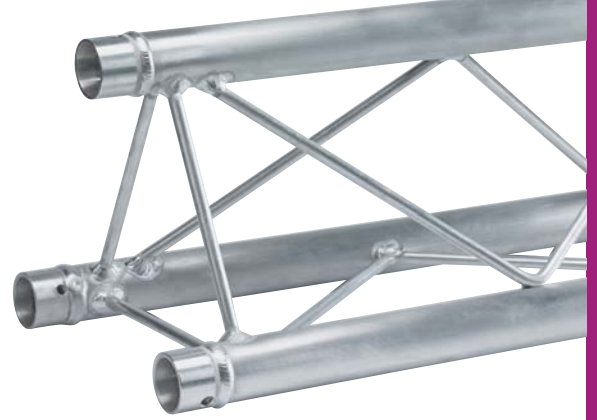

**BT-TRUSS TRIO 22050**

Triangular aluminium truss - 220 mm  
Length 50 cm

Code : B03500

49€<sup>Incl. VAT</sup>

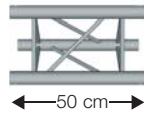

Manufacture according to DIN ISO 4113 and TÜV standards.  
Aluminium alloy truss (EN AW 6082 T6) 50 mm in diameter and 2 mm thick.

**BT-TRUSS TRIO 22100**

Triangular aluminium truss - 220 mm  
Length 100 cm

Code : B03501

89€<sup>Incl. VAT</sup>

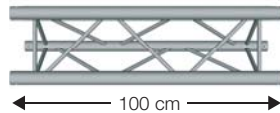

**The BRITEQ® truss is delivered WITHOUT the connection kit**

**BT-TRUSS TRIO 22200**

Triangular aluminium truss - 220 mm  
Length 200 cm

Code : B03502

119€<sup>Incl. VAT</sup>

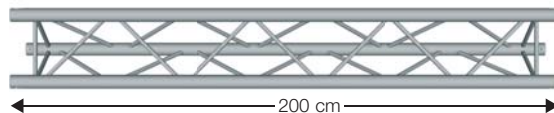

**BT-TRUSS TRIO 22300**

Triangular aluminium truss - 220 mm  
Length 300 cm

Code : B03503

169€<sup>Incl. VAT</sup>

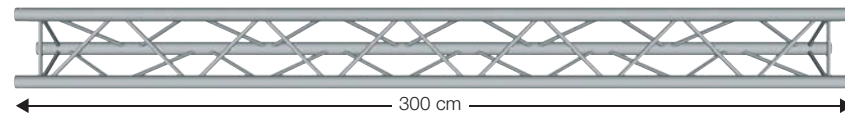

LENGTH (M)		2	3	4	5	6
Max centred load (kg)		217.7	143.2	105.4	82.3	66.4
Deformation (mm)		1.9	4.2	7.5	11.9	17.3
Max distributed load (kg/m)		190.2	95.5	52.7	32.9	22.1
Deformation (mm)		2	5.2	9.3	14.6	21.1

The load tables show the weight limits supported between two fixed hook points.  
Centred or distributed loads cannot be added together. Consult a qualified technician.



# TRIO 220 TRUSS

- The CONTEST® truss comes with :
- 1 x connection kit, angle – 2 directions
  - 2 x connection kits - 3, 4 directions



## DEC022T-AG01

Triangular angle 220  
2 directions - 50 cm 90°

Code : H10232

85€<sup>Incl. VAT</sup>

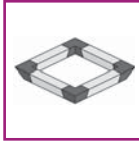

## DEC022T-AG02

Triangular angle 220  
3 directions - 50 cm 90° - upright

Code : H10233

155€<sup>Incl. VAT</sup>



## DEC022T-AG03

Triangular angle 220  
3 directions - 50 cm 90° - left-hand

Code : H10234

155€<sup>Incl. VAT</sup>



## DEC022T-AG04

Triangular angle 220  
3 directions - 90° - flat

Code : H10235

125€<sup>Incl. VAT</sup>

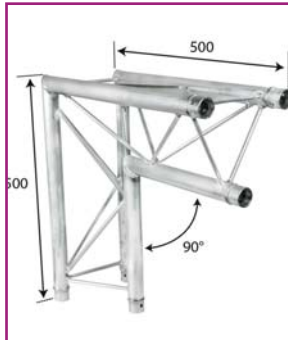

## DEC022T-AG05

Triangular angle 220  
2 directions - 50 cm 90° - right

Code : H10331

89€<sup>Incl. VAT</sup>

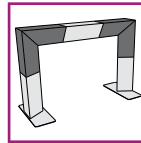

## BT-TRUSS TRIO 22 - A003

Triangular angle 220  
2 directions - 50 cm 90°

Code : B03510

79€<sup>Incl. VAT</sup>

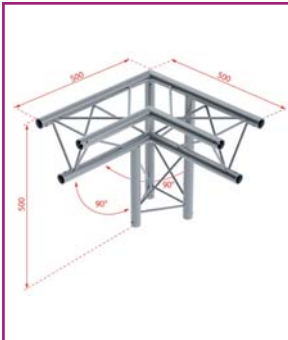
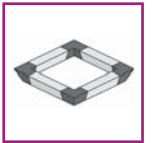

## BT-TRUSS TRIO 22 - A012

Triangular angle 220  
3 directions - 50 cm 90° - upright

Code : B03515

139€<sup>Incl. VAT</sup>



## BT-TRUSS TRIO 22 - A013

Triangular angle 220  
3 directions - 50 cm 90° - left-hand

Code : B03516

139€<sup>Incl. VAT</sup>

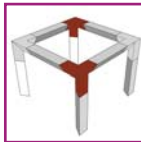

## BT-TRUSS TRIO 22 - A017

Triangular angle 220  
3 directions - 90° - flat

Code : B03517

99€<sup>Incl. VAT</sup>





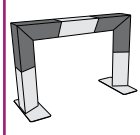

**BT-TRUSS TRIO 22 - A007**  
 Triangular angle 220  
 2 directions - 50 cm 90° - vertical

Code : B03511      79€<sup>Incl. VAT</sup>



**BT-TRUSS TRIO 22 - A016**  
 Triangular angle 220  
 4 directions

Code : B03519      149€<sup>Incl. VAT</sup>

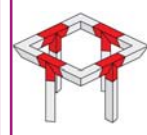

**BT-TRUSS TRIO 22 - A018**  
 Triangular angle 220  
 3 directions

Code : B03518      99€<sup>Incl. VAT</sup>



**BT-TRUSS TRIO 22 - A020**  
 Triangular angle 220  
 4 directions

Code : B03520      169€<sup>Incl. VAT</sup>

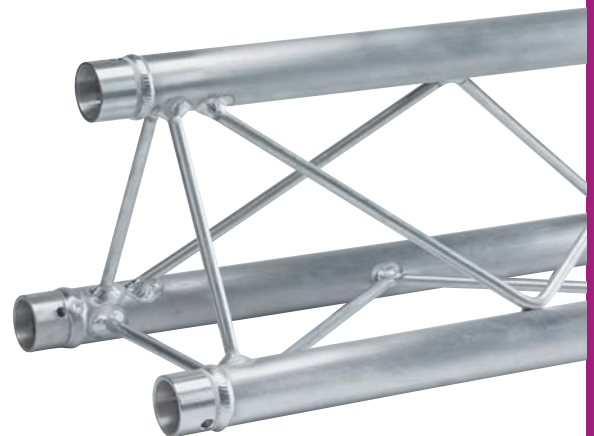

**The BRITEQ® truss is delivered WITHOUT the connection kit**



# TRIO 220 TRUSS



## DECO22T-EM-B1

Trio 220 baseplate with conical couplers, spigot pins and Safety R-springs

Code : H10237 55.90€<sup>Incl. VAT</sup>



## BT-TRUSS TRIO/ QUAT 22 - BASEPLATE

Trio/Quatro 220 baseplate + half-couplers

Code : B03530 55.90€<sup>Incl. VAT</sup>



## DECO22-EMB2

Rectangular baseplate for Deco arch for tube of 35.620 x 240 mm

Code : H10333 69€<sup>Incl. VAT</sup>



## DECO22-MANCH

Conical coupler for Deco series aluminium truss

Code : H10226 4.50€<sup>Incl. VAT</sup>



## DECO22-1/2MANCH

1/2 conical coupler and M8 screw for tube of 35

Code : H10332 6€<sup>Incl. VAT</sup>



## DECO22-CLAV

Spigot pin for conical coupler DECO22 series by unit

Code : H10227 2.50€<sup>Incl. VAT</sup>



## DECO22-GOUP

Safety R-spring for spigot pin

Code : H10228 0.60€<sup>Incl. VAT</sup>



## DECO22T-MC-KIT

Set of 3 conical couplers, 6 spigot pins and 6 Safety R-springs

Code : H10236 25€<sup>Incl. VAT</sup>



## BT-TRUSS TRIO 22 - COUPLER SET

Set of 3 conical couplers, 6 spigot pins and 6 Safety R-springs

Code : B03531 16.50€<sup>Incl. VAT</sup>



# TRIO 200 TRUSS



The CONTEST® truss comes with :

- 1 connection kit per bar
- 1 x M8 fasteners kit for hanging projectors



**PT20-50**  
Metal truss - 200 mm  
Length 50 cm

---

Code : H10033      39€<sup>Incl. VAT</sup>

---

**PT20-75**  
Metal truss - 200 mm  
Length 75 cm

---

Code : H10034      45€<sup>Incl. VAT</sup>

---

**PT20-100**  
Metal truss - 200 mm  
Length 100 cm

---

Code : H10035      55€<sup>Incl. VAT</sup>

---

**PT20-150**  
Metal truss - 200 mm - 1.50 m length With  
5 hooks

---

Code : H8261      65€<sup>Incl. VAT</sup>

---

LENGTH IN (M)		1.5	3	4.5	6	7.5
Max centred load (kg)		100	80	59	45	30
Max distributed load (kg/m)		97	38	15	9	6

The load tables show the weight limits supported between two fixed hook points.  
Centred or distributed loads cannot be added together. Consult a qualified technician.



**AG20-021**  
Angle - 200 mm 90° - 2 directions -

---

Code : H8263      45€<sup>Incl. VAT</sup>

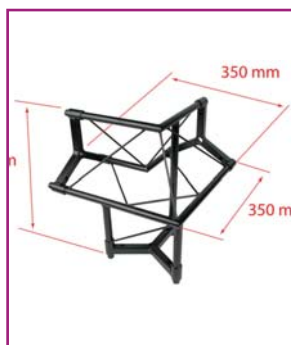

**AG20-033**  
Angle - 200 mm 90° - 3 directions -  
Lower upright vertex

---

Code : H8264      55€<sup>Incl. VAT</sup>



**AG20-034**  
Angle - 200 mm 90° - 3 directions  
Apex down, left

---

Code : H10584      55€<sup>Incl. VAT</sup>

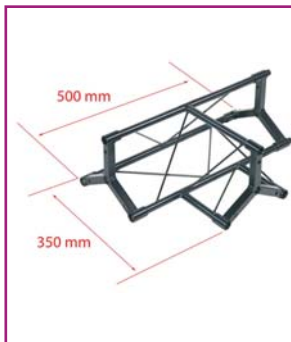

**AG20-035**  
Horizontal tee - 200 mm - 3 directions

---

Code : H8265      65€<sup>Incl. VAT</sup>



**AG20-036**  
Vertical tee - 200 mm - 3 directions -  
Apex down

---

Code : H8266      65€<sup>Incl. VAT</sup>



**EM20-BASE**  
Wall or floor baseplate For 200 mm steel  
truss

---

Code : H8267      20€<sup>Incl. VAT</sup>



# DUO 290 TRUSS



Manufacture according to DIN ISO 4113 and TÜV standards.  
Aluminium alloy truss (EN AW 6082 T6) 50 mm in diameter and 2 mm thick.

**50 mm tubes**  
**16 mm braces**  
**Ladder with 240 mm spacing between each tube (290 mm exterior)**

**Assembly with conical coupler, spigot pin and Safety R-spring**  
**Section: 290 mm**

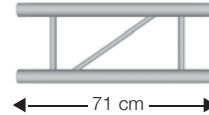
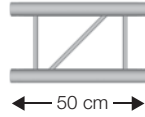
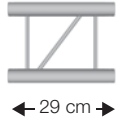

## DU029-029

290 mm aluminium ladder - Length 29 cm

Code : H10036 65€<sup>Incl. VAT</sup>



## DU029-050

290 mm aluminium ladder  
Length 50 cm

Code : H10037 69€<sup>Incl. VAT</sup>



## DU029-071

290 mm aluminium ladder  
Length 71 cm

Code : H10607 79€<sup>Incl. VAT</sup>



## DU029-100

290 mm aluminium ladder  
Length 100 cm

Code : H10038 85€<sup>Incl. VAT</sup>

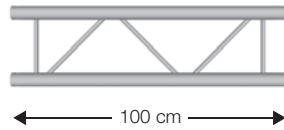

**The CONTEST® truss comes with :**  
• 1 connection kit per bar

**The DU0290 Contest series and the BT-TRUSS DU0 Briteq series are not compatible with each other (trusses and angles)**

## DU029-200

290 mm aluminium ladder  
Length 200 cm

Code : H10039 109€<sup>Incl. VAT</sup>

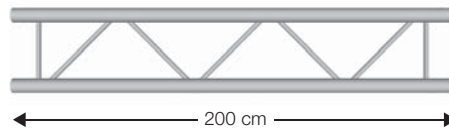

## DU029-300

290 mm aluminium ladder  
Length 300 cm

Code : H10040 139€<sup>Incl. VAT</sup>

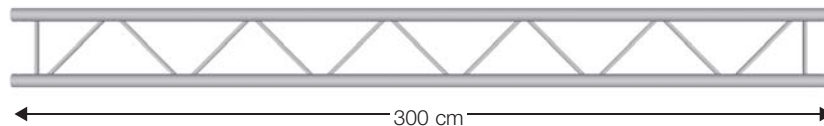

LENGTH (M)		2	3	4	5	6
Max centred load (kg)		904.3	787.9	589.1	469.4	389.2
Deformation (mm)		2.4	6.9	12.3	19.3	27.8
Max distributed load (kg/m)		452.2	300.7	225.0	179.6	129.7
Deformation (mm)		1.5	5.0	11.8	23.0	34.6

The load tables show the weight limits supported between two fixed hook points.

Centred or distributed loads cannot be added together. Consult a qualified technician.



Manufacture according to DIN ISO 4113 and TÜV standards.  
Aluminium alloy truss (EN AW 6082 T6) 50 mm in diameter and 2 mm thick.

**50 mm tubes**  
**16 mm braces**  
**Ladder with 240 mm spacing**  
**between each tube (290 mm exterior)**

**Assembly with conical coupler, spigot pin and Safety R-spring**  
**Section: 290 mm**

**BT-TRUSS DUO 29050**  
290 mm aluminium ladder  
Length 50 cm

---

Code : B03449      49€<sup>Incl. VAT</sup>

---

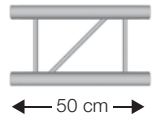



**BT-TRUSS DUO 29100**  
290 mm aluminium ladder  
Length 100 cm

---

Code : B03450      59€<sup>Incl. VAT</sup>

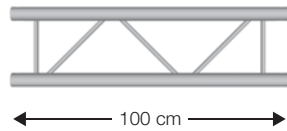
---





**BT-TRUSS DUO 29200**  
290 mm aluminium ladder  
Length 200 cm

---

Code : B03451      94.90€<sup>Incl. VAT</sup>

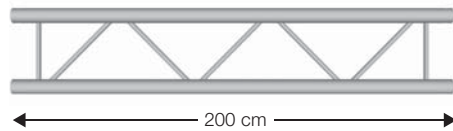
---





**BT-TRUSS DUO 29300**  
290 mm aluminium ladder  
Length 300 cm



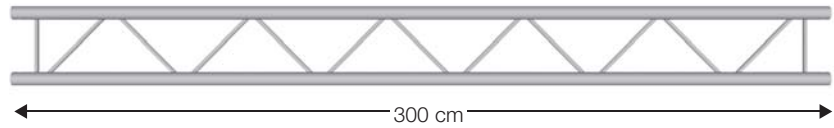

---

Code : B03452      119€<sup>Incl. VAT</sup>

---

**The BRITEQ® truss is delivered WITHOUT the connection kit**  
**The DU0290 Contest series and the BT-TRUSS DUO Briteq series are not compatible (trusses and angles)**

LENGTH (M)		2	3	4	5	6
Max centred load (kg)		904.3	787.9	589.1	469.4	389.2
Deformation (mm)		2.4	6.9	12.3	19.3	27.8
Max distributed load (kg/m)		452.2	300.7	225.0	179.6	129.7
Deformation (mm)		1.5	5.0	11.8	23.0	34.6

The load tables show the weight limits supported between two fixed hook points.  
Centred or distributed loads cannot be added together. Consult a qualified technician.



# DUO 290 TRUSS

- The CONTEST® truss comes with :
- 1 x connection kit, angle - 2 directions
  - 2 x connection kits, angle - 2, 3, 4 directions

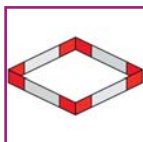

**AGDU029-01**  
Corner joint - 2 directions - 90° - upright

Code : H10041 109€<sup>Incl. VAT</sup>

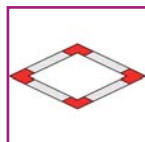
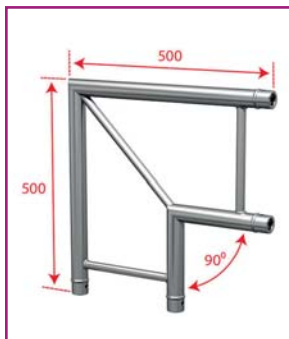

**AGDU029-02**  
Corner joint - 2 directions - 90° - flat

Code : H10042 99€<sup>Incl. VAT</sup>

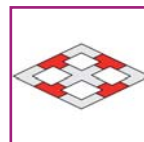
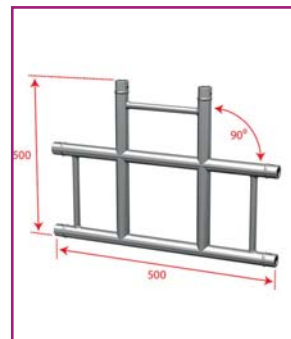

**AGDU029-03**  
Corner joint - 3 directions - 90° - flat

Code : H10043 129€<sup>Incl. VAT</sup>

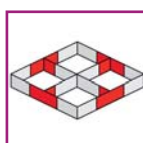

**AGDU029-04**  
Corner joint - 3 directions - 90° - upright

Code : H10044 139€<sup>Incl. VAT</sup>

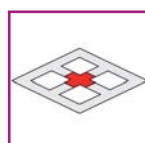
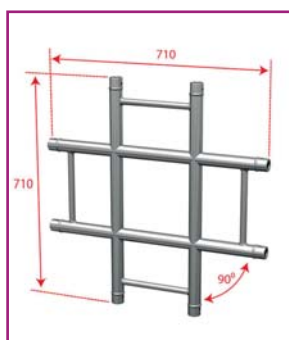

**AGDU029-05**  
Corner joint - 4 directions - 90° - flat

Code : H10045 159€<sup>Incl. VAT</sup>

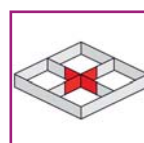
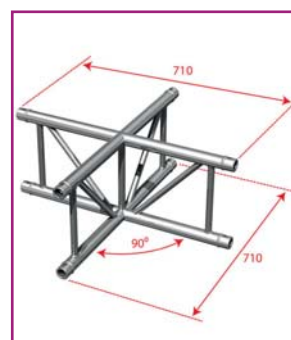

**AGDU029-06**  
Corner joint - 4 directions - 90° - upright

Code : H10046 179€<sup>Incl. VAT</sup>



**AGDU0-07**  
Corner joint - 3 directions - 45° - upright

Code : H10863 109€<sup>Incl. VAT</sup>



**AGDU0-08**  
Corner joint - 3 directions - 90° - upright

Code : H10864 129€<sup>Incl. VAT</sup>



**AGDU0-09**  
Corner joint - 3 directions - 45° - flat

Code : H10865 109€<sup>Incl. VAT</sup>



The BRITEQ® truss is delivered WITHOUT the connection kit

Attention: we provide the circles on demand. 60 days lead time.



**BT-TRUSS DUO 29-A007**

Aluminium ladder truss. Angle 90°.

Code : B03457 95€<sup>Incl. VAT</sup>



**BT-TRUSS DUO 29-A003**

Aluminium ladder truss. Angle 90°.

Code : B03456 95€<sup>Incl. VAT</sup>



**duo 290 circle 2m**

DUO 290 truss, circle D=2m, Horizontal

Code : B03463 499€<sup>Incl. VAT</sup>



**duo 290 circle 3m**

DUO 290 truss, circle D=3m, Horizontal

Code : B03462 759€<sup>Incl. VAT</sup>



**duo 290 circle 4m**

DUO 290 truss, circle D=4m, Horizontal

Code : B03461 999€<sup>Incl. VAT</sup>



**BT-TRUSS DUO 29**

DUO 290 truss, circle D=5m, Horizontal

Code : B03460 1290€<sup>Incl. VAT</sup>



**EMDU0-B1**

DUO baseplate 290 mm with conical couplers, spigot pins and Safety R-springs

Code : H10048 45€<sup>Incl. VAT</sup>



**MCDU0-KIT**

With 2 conical couplers, 4 spigot pins and 4 Safety R-springs

Code : H10047 19€<sup>Incl. VAT</sup>



**SSL-Duo**

Support for DUO29 ladder on 35 mm base

Code : H10609 39€<sup>Incl. VAT</sup>



# UNO TRUSS

The CONTEST® truss comes with :

- 1x coupler per tube
- 2x coupler per angle



**UNO-50**  
Aluminium tube Diameter 50 mm  
length 50 cm

Code : H10238      30€<sup>Incl. VAT</sup>



**UNO-100**  
Aluminium tube Diameter 50 mm  
length 100 cm

Code : H10239      36€<sup>Incl. VAT</sup>



**UNO-150**  
Aluminium tube Diameter 50 mm  
length 150 cm

Code : H10240      43€<sup>Incl. VAT</sup>



**UNO-200**  
Aluminium tube Diameter 50 mm  
length 200 cm

Code : H10241      49€<sup>Incl. VAT</sup>



**UNO-50B**  
Aluminium tube Diameter 50 mm  
length 50 cm-Black

Code : H10417      35€<sup>Incl. VAT</sup>



**UNO-100B**  
Aluminium tube Diameter 50 mm  
length 100 cm-Black

Code : H10418      42€<sup>Incl. VAT</sup>



**UNO-150B**  
Aluminium tube Diameter 50 mm  
length 150 cm-Black

Code : H10419      50€<sup>Incl. VAT</sup>



**UNO-200B**  
Aluminium tube Diameter 50 mm  
length 200 cm-Black

Code : H10420      59€<sup>Incl. VAT</sup>







**BT-TRUSS Tube BLK 250**  
Extension for 'T' DROP ARM or 'H' FRAME.

Code : B03485 49€<sup>Incl. VAT</sup>



**BT-TRUSS Tube BLK 500**  
Extension for 'T' DROP ARM or 'H' FRAME.

Code : B03486 49€<sup>Incl. VAT</sup>



**BT-TRUSS Tube BLK 1000**  
Extension for 'T' DROP ARM or 'H' FRAME.

Code : B03487 59€<sup>Incl. VAT</sup>



**BT-TRUSS Tube BLK 2000**  
Extension for 'T' DROP ARM or 'H' FRAME.

Code : B03488 73.9€<sup>Incl. VAT</sup>



**UNO-AG01v2**  
Angle for tube Diameter 50 mm UNO + 2 x 1/2 coupler + spigot pin

Code : H10612 40€<sup>Incl. VAT</sup>



**UNO-1/2MANCH**  
Additional half coupler for angle UNO-AG01

Code : H10254 12€<sup>Incl. VAT</sup>



**UNO-T**  
Suspension T for hanging projectors 50 mm tube

Code : H10334 69€<sup>Incl. VAT</sup>



**UNO-H**  
H-Frame for hanging projectors 50 mm tube

Code : H10335 99€<sup>Incl. VAT</sup>



**UNO-A**  
Suspension bracket for projector for 50 mm tube. L 188 mm H 240 mm

Code : H10336 35.90€<sup>Incl. VAT</sup>

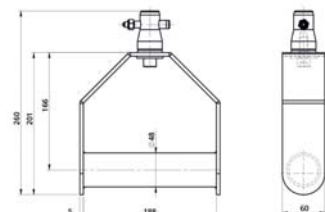
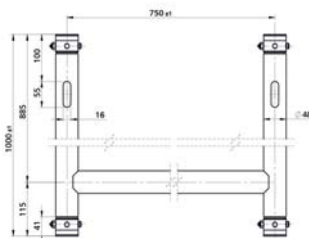
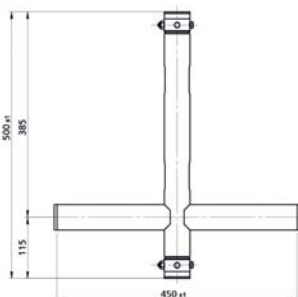

# UNO TRUSS



**BT-TRUSS T-Drop arm  
BLK 450x195**  
Suspension T for hanging projectors

Code : B03483 56.90€<sup>Incl. VAT</sup>



**BT-TRUSS T-Drop arm  
BLK 450x445**  
Suspension T for hanging projectors

Code : B03482 56.90€<sup>Incl. VAT</sup>



**BT-TRUSS T-Drop arm Thru  
BLK 450x500**  
Suspension T for hanging projectors

Code : B03484 69€<sup>Incl. VAT</sup>



**BT-TRUSS H-Frame  
BLK 750x1000**  
H-Frame to hang projectors

Code : B03481 99€<sup>Incl. VAT</sup>



**BT-TRUSS H-Frame  
BLK 750x415**  
H-Frame to hang projectors

Code : B03480 109€<sup>Incl. VAT</sup>



**BT-TRUSS Stirrup BLK**  
Projector suspension bracket for 50 mm tube.  
L 188 mm H 240 mm

Code : B03489 35.90€<sup>Incl. VAT</sup>

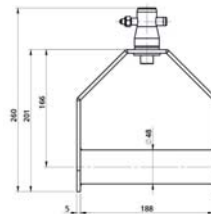
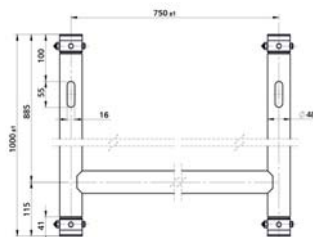
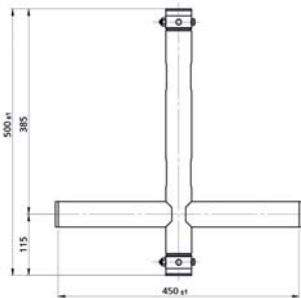

# DECO TRUSS



## DT10-150

DECO TRUSS, L=1.50m and couplers included

Code : B03033

109€<sup>Incl. VAT</sup>



## DT-10 BOX CORNER

DECO TRUSS, box corner (BOX KIT not included)

Code : B03040

49,90€<sup>Incl. VAT</sup>



## DT-10 BOX KIT

DECO TRUSS, set of 4 couplers for box corner

Code : B03041

19€<sup>Incl. VAT</sup>



## DT10-CLAMP

Clamp for 20 mm diameter tubes

Code : B03039

3.49€<sup>Incl. VAT</sup>

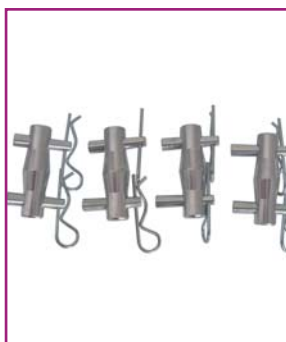

## DT10-COUPLER SET

DECO TRUSS, set of 4 couplers including spigot pins + security R-springs

Code : B03038

17.90€<sup>Incl. VAT</sup>



# TOTEMS



## TOTEM CONTEST® is delivered with:

- 4x Tubes
- 2x Baseplates
- 2x Connection kits
- 1x Spandex textile



### TOT-100

Totem height 100 cm  
With baseplates and fabrics

Code : H10243      359€<sup>Incl. VAT</sup>



### TOT-150

Totem height 150 cm  
With baseplates and fabrics

Code : H10244      389€<sup>Incl. VAT</sup>



### TOT-200

Totem height 200 cm  
With baseplates and fabrics

Code : H10245      419€<sup>Incl. VAT</sup>



## TOTEM BRITEQ® is delivered with:

- 4x Tubes
- 2x Baseplates
- 2x Connection kits
- 1x Spandex textile



### BT-TRUSS STAND 100

Totem height 100 cm  
With baseplates and fabrics

Code : B03490      359€<sup>Incl. VAT</sup>



### BT-TRUSS STAND 150

Totem height 150 cm  
With baseplates and fabrics

Code : B03491      389€<sup>Incl. VAT</sup>



### BT-TRUSS STAND 200

Totem height 200 cm  
With baseplates and fabrics

Code : B03492      419€<sup>Incl. VAT</sup>





**BT-TRUSS STAND  
100 TUBES**  
Tubes for 100 cm TOTEM

Code : B03470 179€<sup>Incl. VAT</sup>



**BT-TRUSS STAND  
150 TUBES**  
Tubes for 150 cm TOTEM

Code : B03471 209€<sup>Incl. VAT</sup>



**BT-TRUSS STAND  
150 TUBES**  
Tubes for 200 cm TOTEM

Code : B03472 244,90€<sup>Incl. VAT</sup>



**TOT-BASEground**  
Floor baseplate for Totem with 4 half-couplers

Code : H10255 109€<sup>Incl. VAT</sup>



**TOT-BASEtop**  
Upper baseplate for Totem with 4 half-couplers

Code : H10256 79€<sup>Incl. VAT</sup>



**TOT-CIRCLE**  
Circle in tube of 50 of 96 cm diam. for Totem

Code : H10834 209€<sup>Incl. VAT</sup>



**BT-TRUSS STAND  
BASEPLATE ASSY**

Code : B03473 179€<sup>Incl. VAT</sup>



**TOT-CIRCLE is the only circle held in stock**



**TOT-Spandex1**  
Elastic fire-resistant textile for 1m Totem

Code : H10257 29€<sup>Incl. VAT</sup>



**TOT-Spandex1.5**  
Elastic fire-resistant textile for 1.5m Totem

Code : H10258 39€<sup>Incl. VAT</sup>



**TOT-Spandex2**  
Elastic fire-resistant textile for 2m Totem

Code : H10259 47€<sup>Incl. VAT</sup>



**TOT-Spandex1No**  
Elastic textile for 1m Totem - Black

Code : H10740 29€<sup>Incl. VAT</sup>



**TOT-Spandex1.5No**  
Elastic textile for 1.5m Totem - Black

Code : H10741 39€<sup>Incl. VAT</sup>



**TOT-Spandex2No**  
Elastic textile for 2m Totem - Black

Code : H10742 47€<sup>Incl. VAT</sup>



# HOOK ACCESSORIES



<b>A</b>	1/2MANCH Code : H6530	Conical half coupler Supplied with M12 x 12 screws, countersunk head	8.30€ <sup>incl. VAT</sup>		<b>B</b>	1/2MANCH-M10 Code : H10323	Conical half coupler with M10 screw for 50 mm tube	8.20€ <sup>incl. VAT</sup>	
<b>C</b>	CCT-20 Code : H7834	Professional clamp For 20 mm tube	3.90€ <sup>incl. VAT</sup>		<b>D</b>	CR20 Code : B02659	Professional clamp For 16-20 mm tube	4.49€ <sup>incl. VAT</sup>	
<b>E</b>	CR 30/LI Code : B02666	Clamp with protection plate.	6.90€ <sup>incl. VAT</sup>		<b>F</b>	CR30 Code : B02661	Professional clamp For 20-30 mm tube.	5.90€ <sup>incl. VAT</sup>	
<b>G</b>	CCT-50 Code : H3242	Professional clamp For 30 to 50 mm tube	4.80€ <sup>incl. VAT</sup>		<b>H</b>	CCT-50B Code : H10414	Professional clamp For 30 to 50 mm tube-Black	6.40€ <sup>incl. VAT</sup>	
<b>I</b>	CR50 Code : B02660	Professional clamp For 30-50 mm tube	5.90€ <sup>incl. VAT</sup>		<b>J</b>	CR50/LI Code : B02662	Clamp with protection plate.	6.90€ <sup>incl. VAT</sup>	
<b>K</b>	CCT-52 Code : H10330	Straight clamp with protection plate for 50 mm tube	9.30€ <sup>incl. VAT</sup>		<b>L</b>	CCT-55 Code : H7835	Clamp with protection plate For 30 to 50 mm tube	6.50€ <sup>incl. VAT</sup>	
<b>M</b>	CCT-55B Code : H10415	Clamp with protection plate for 30 to 50 mm tube-Black	8.20€ <sup>incl. VAT</sup>		<b>N</b>	CLAV Code : H6524	spigot pen for conical coupler / per piece	2.30€ <sup>incl. VAT</sup>	
<b>O</b>	CLAV/M8 Code : H7840	Key for conical coupler with M8 screw	3.20€ <sup>incl. VAT</sup>		<b>P</b>	CLP-250-B Code : H10348	Aluminium clamp for 50 mm tube - 250 kg load - Black	35.90€ <sup>incl. VAT</sup>	
<b>Q</b>	CLP-250-S Code : H10347	Aluminium clamp for tube 50 mm - 250 kg load - Silver	35.90€ <sup>incl. VAT</sup>		<b>R</b>	CLP-MANCH Code : H10832	CLP250S clamp + half coupler + M8 Spigot pen	49.90€ <sup>incl. VAT</sup>	
<b>S</b>	BT-TRUSS Code : B03479	Clamp with 1/2 coupler: BLACK ALU - SWL:100 kg	34.90€ <sup>incl. VAT</sup>		<b>T</b>	FAST CLAMP V2 Code : B02684	Quick fastening clamp for trusses with tubes from 48 to 51 mm diameter.	13.90€ <sup>incl. VAT</sup>	
<b>U</b>	ULTRA CLAMP Code : B06600	ULTRA CLAMP black Ultra fast clamp SWL 150kg tube 48-51mm	19.90€ <sup>incl. VAT</sup>		<b>V</b>	OMEGA BRACKET BIG Code : B02678	OMEGA clamp. Big version. Hole distance (centre to centre) : 141 mm.	11.90€ <sup>incl. VAT</sup>	
<b>W</b>	OMEGA BRACKET SMALL Code : B02677	OMEGA clamp. Small version. Hole distance (centre to centre) : 106 mm.	8.90€ <sup>incl. VAT</sup>		<b>X</b>	CLP-50-B Code : H10329	Aluminium clamp for 50 mm tube - 120 kg load - Black	33.20€ <sup>incl. VAT</sup>	
<b>Y</b>	CLP-50-S Code : H10328	Aluminium clamp for 50 mm tube - 120 kg load - Silver	33.20€ <sup>incl. VAT</sup>		<b>Z</b>	CLR-35 Code : H10324	Aluminium clamp for 35 mm tube - 50 kg load	12.90€ <sup>incl. VAT</sup>	
<b>A1</b>	CLR-70 Code : H10325	Double aluminium clamp for 35mm tube - 50 kg load	27.50€ <sup>incl. VAT</sup>		<b>B1</b>	CLR-100 Code : H10028	Double clamp For 50 mm tube	45€ <sup>incl. VAT</sup>	
<b>C1</b>	CLR-150 Code : H10326	Aluminium clamp for 50 mm tube - 100 kg load	13.70€ <sup>incl. VAT</sup>		<b>D1</b>	CLR-250 Code : H10327	Double aluminium clamp For 50 mm tube - 100 kg load	23€ <sup>incl. VAT</sup>	
<b>E1</b>	SWIVEL CLAMP 302-V2 Code : B02682	Double mounting clamp that can rotate 360°.	19€ <sup>incl. VAT</sup>		<b>F1</b>	SWIVEL CLAMP 502-V2 Code : B02683	Double mounting clamp that can rotate 360°	26.90€ <sup>incl. VAT</sup>	
<b>G1</b>	CLR-50 Code : H7836	Aluminium clamp For 50 mm tube	32€ <sup>incl. VAT</sup>		<b>H1</b>	CLR50B Code : H10416	Aluminium clamp For 50 mm tube-Black	37.60€ <sup>incl. VAT</sup>	
<b>I1</b>	ALU CLAMP 101-V2 Code : B02687	Fixing clamp for trusses with 48-51 mm diameter tubes.	6.90€ <sup>incl. VAT</sup>		<b>J1</b>	ALU CLAMP 301-V2 Code : B02680	Fixing clamp for heavy duty applications for tubes from 48 to 51 mm diameter.	11.90€ <sup>incl. VAT</sup>	

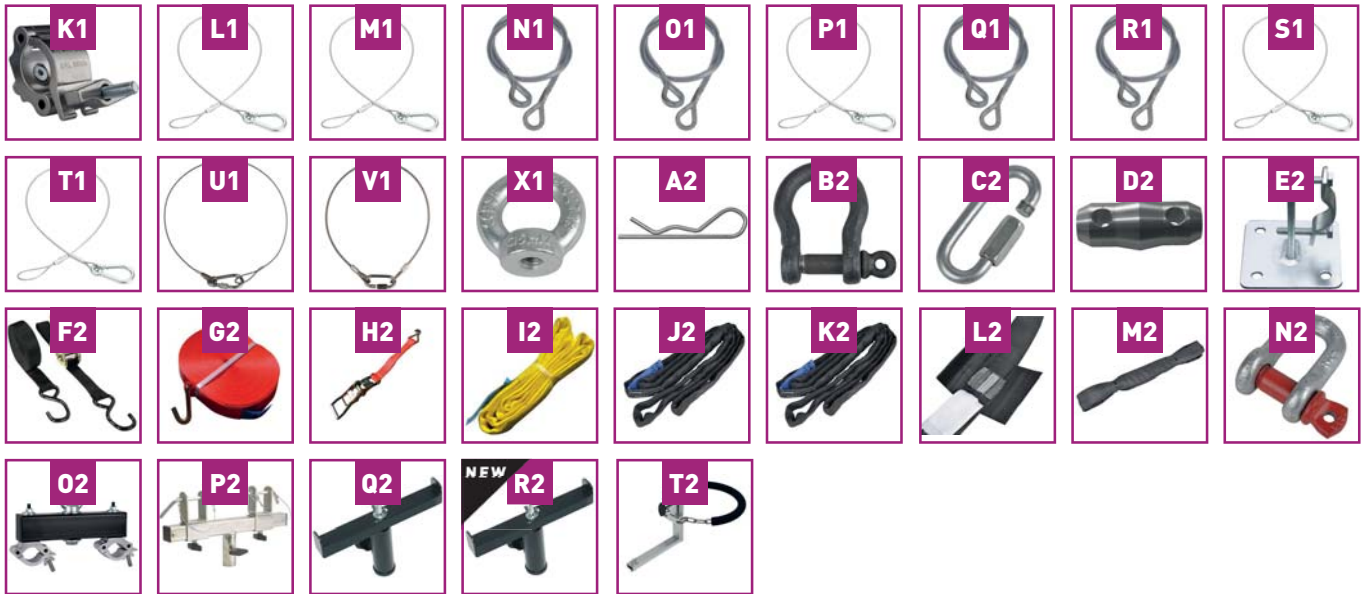

<b>K1</b>	ALU CLAMP 801-V2 Code : B02681	Fixing clamp for heavy duty applications for tubes up to 48 mm diameter 51 mm	16,90€ <sup>incl. VAT</sup>		<b>L1</b>	ELG0615 Code : H10459	Sheathed cable - 6 mm diameter and 150 cm length - MWL 400 kg	25€ <sup>incl. VAT</sup>	
<b>M1</b>	ELG0620 Code : H10460	Sheathed cable - 6 mm diameter and 200 cm length - MWL 400 kg	25€ <sup>incl. VAT</sup>		<b>N1</b>	ELG0815 Code : H10461	Sheathed cable - 8 mm diameter and 150 cm length - MWL 700 kg	27€ <sup>incl. VAT</sup>	
<b>O1</b>	ELG0820 Code : H10462	Sheathed cable - 8 mm diameter and 200 cm length - MWL 700 kg	29€ <sup>incl. VAT</sup>		<b>P1</b>	ELG1003 Code : H9971	3 mm steel wire. Length 100 cm, 1 quick-release clip	6€ <sup>incl. VAT</sup>	
<b>Q1</b>	ELG1015 Code : H10444	Sheathed cable - 10 mm diameter and 150 cm length - MWL 1000 kg	33€ <sup>incl. VAT</sup>		<b>R1</b>	ELG1020 Code : H10445	Sheathed cable - 10 mm diameter and 200 cm length - MWL 1000 kg	38€ <sup>incl. VAT</sup>	
<b>S1</b>	ELG301 Code : H9967	1 mm steel wire. L30 cm 1 quick-release clip	4€ <sup>incl. VAT</sup>		<b>T1</b>	ELG602 Code : H9969	2 mm steel wire. Length 60 cm, 1 quick-release clip	5,30€ <sup>incl. VAT</sup>	
<b>U1</b>	SAFETY CABLE Code : B02685	Safety cable, diameter 2 mm, Length 60 cm.	2,49€ <sup>incl. VAT</sup>		<b>V1</b>	SAFETY CABLE D4-60CM Code : B02686	4 mm steel wire. Length 60 cm.	6,29€ <sup>incl. VAT</sup>	
<b>X1</b>	EYE-10F Code : H10436	Female M10 eye bolt MWL 230 kg	3,30€ <sup>incl. VAT</sup>						
<b>A2</b>	GOUP Code : H6525	Security R-spring by unit	0,40€ <sup>incl. VAT</sup>		<b>B2</b>	HOOK-1000 Code : H10434	High resistance shackle MWL 1000 kg	5,50€ <sup>incl. VAT</sup>	
<b>C2</b>	MAIL-750 Code : H10435	Connection link for 750 kg MWL cable	9,20€ <sup>incl. VAT</sup>		<b>D2</b>	MANCH Code : H6523	Conical coupler by unit	5,50€ <sup>incl. VAT</sup>	
<b>E2</b>	PAT-50 Code : H7838	Fixing plate For 50 mm tube	35€ <sup>incl. VAT</sup>		<b>F2</b>	SAN-00 Code : H10441	Ratchet strap and 5m 2000 kg MWL hook	22€ <sup>incl. VAT</sup>	
<b>G2</b>	SAN-01 Code : H10030	Safety strap 2000Kg MWL	78,50€ <sup>incl. VAT</sup>		<b>H2</b>	SAN-02 Code : H10031	Binding band 2000Kg MWL	20,40€ <sup>incl. VAT</sup>	
<b>I2</b>	SAN-03 Code : H10032	Strap - 4m length, 2000Kg MWL	20,40€ <sup>incl. VAT</sup>		<b>J2</b>	SAN-04 Code : H10437	Useful 1.5m tubular textile strap 1000 kg MWL	9,10€ <sup>incl. VAT</sup>	
<b>K2</b>	SAN-05 Code : H10438	Useful 2m tubular textile strap 1000 kg MWL	11,90€ <sup>incl. VAT</sup>		<b>L2</b>	SAN-06 Code : H10439	Useful 1.5m tubular core steel strap 1000 kg MWL	37,50€ <sup>incl. VAT</sup>	
<b>M2</b>	SAN-07 Code : H10440	Useful 2m tubular core steel strap 1000 kg MWL	50€ <sup>incl. VAT</sup>		<b>N2</b>	SHA-01 Code : H10029	Metal shackle - 2000 kg MWL	20€ <sup>incl. VAT</sup>	
<b>O2</b>	SPT290 Code : H10027	Suspension piece for 290 mm truss	95,20€ <sup>incl. VAT</sup>		<b>P2</b>	SST-35 Code : H3240	150 to 350 mm truss support for 35 mm base	59€ <sup>incl. VAT</sup>	
<b>Q2</b>	SST-20 Code : H8262	Fixing tee for PT20-150 truss on 28 mm base	10€ <sup>incl. VAT</sup>		<b>R2</b>	SST-22 Code : H10873	Fixing T for 220 Truss on 35mm base	24€ <sup>incl. VAT</sup>	
<b>S2</b>	SUP-PIL Code : H10608	Post support with clamping chain	59€ <sup>incl. VAT</sup>						



# WINCH STANDS



Self-locking gear winch, combined with quality components and workmanship for high stability.

Transport and installation are facilitated by three articulated legs.

Ergonomic clamping wheel to eliminate play in the mast.



**ELV-400PRO**  
Self-braking winch stand with 3 sections  
4 metres - 80 kg

---

Code : H9996      429€<sup>Incl. VAT</sup>

---



Material: Treated steel  
Electro-galvanized finish and black epoxy paint  
Top mast: Ø 35 mm  
Winch: Self-braking anti-return gear  
Cable: Galvanized steel, diameter 5 mm  
Max height: : 4.00 m  
Max load: : 80 kg  
Folded length: 1.59 m  
Weight: 23 kg  
TUV approved



**LS-400**  
Self-braking winch stand - 4.00m / 80 kg

---

Code : B00748      319€<sup>Incl. VAT</sup>

---



Winch stand with automatic brake and lockable safety  
Max height: : 4.00 m  
Baseplate: 1.15-1.50m  
Section of the last mat: 35 mm  
Maximum load: 80 kg  
Folded length: 1.60 m  
Weight: 18 kg  
Made in France  
TUV, GS approved



**ELV-270PRO**  
Self-braking winch stand with 2 sections  
2.7 metres - 60 kg

---

Code : H9995      249€<sup>Incl. VAT</sup>

---



Material: Treated steel  
Electro-galvanized finish and black epoxy paint  
Top mast: Ø 35 mm  
Winch: Self-braking anti-return gear  
Cable: Galvanized steel, diameter 3 mm  
Max height: : 2.70 m  
Max load: : 60 kg  
Folded length: 1.60 m  
Weight: 12 kg  
TUV approved



**LS-290**  
Self-braking winch stand - 3.00m / 60 kg

---

Code : B00747      259€<sup>Incl. VAT</sup>

---



Winch stand with automatic brake and lockable safety  
Max height: : 3.00 m  
Baseplate: 1.20 m  
Section of the last mat: 35 mm  
Maximum load: 60 kg  
Folded length: 1.55 m  
Weight: 12 kg  
Made in France  
TUV, GS approved





**LS-270**  
Economical self-braking 2.70m winch stand

---

Code : B00738      99€<sup>Incl. VAT</sup>

---



Winch stand with automatic brake and lockable safety  
Max height: : 2.70 m  
Section of the last mat: 35 mm  
Weight: 11 kg  
TUV, GS approved





# FLOOR CABLE PROTECTORS

The range of Contest® floor cable protectors is designed to protect your cables during your events. Made of Polyurethane to withstand external aggressions, strong compressions and fire-resistant treatments. They are modular and adapt to the surface.

Easy to use and compact, they can be used temporarily or intensively. In addition, their covers are designed not to open unexpectedly and thus ensure to keep your cables safe.



## XC233

Cable protector with 2 3x3 cm channels and cover - 1m length

Code : H10426

109€<sup>Incl. VAT</sup>



## XC233AG

45° angle for XC233 cable protector

Code : H10427

45€<sup>Incl. VAT</sup>



## XC14

Cable protector with one single channel - 1m length

Code : H10425

35€<sup>Incl. VAT</sup>



## XC5-121

Flexible cable protector with 5 channels. 121mm - 9 m

Code : H10735

129€<sup>Incl. VAT</sup>



Materials: Rubber - polyurethane (base) polyurethane + PVC (cover)  
 Fire resistance: Class B1  
 Electrical safety: Directive 73/23/CE  
 Cable channels: 2  
 Cable channel: 30 mm  
 Static load: 2500 kg on a surface of 20 x 20 cm  
 Width: 250 mm  
 Length: 1000 mm  
 Height: 45 mm  
 Weight: 7.9 Kg

Materials: Rubber - polyurethane (base) polyurethane + PVC (cover)  
 Fire resistance: Class B1  
 Electrical safety: Directive 73/23/CE  
 Cable channels: 2  
 Cable channel: 30 mm  
 Static load: 2500 kg on a surface of 20 x 20 cm  
 Width: 250 mm  
 Length: 285 mm  
 Height: 45 mm  
 Weight: 3 Kg

Materials: Polyurethane  
 Fire resistance: Class B1  
 Electrical safety: Directive 73/23/CE  
 Cable channels: 1  
 Cable channel: 38 mm x 13 mm  
 Static load: 100 kg on a surface of 20 x 20 cm  
 Width: 135 mm  
 Length: 1000 mm  
 Height: 35 mm  
 Weight: 2 Kg

Materials: Injection moulded 80% virgin PVC - 20% NBR  
 Fire resistance: Class B1  
 Electrical safety: Directive 73/23/EC  
 Cable channels: 5  
 Cable channel: 16.7 x 15 mm  
 Static load: 200Kg  
 Width: 121 mm  
 Length: 9m  
 Height: 23 mm  
 Weight: 16.5 Kg



## XC5-64

Flexible cable protector with 5 channels. 64mm - 9 m length

Code : H10734

49€<sup>Incl. VAT</sup>



Materials: Injection moulded 80% virgin PVC - 20% NBR  
 Fire resistance: Class B1  
 Electrical safety: Directive 73/23/CE  
 Cable channels: 5  
 Cable channel: 14 x 9.7 mm  
 Static load: 200Kg  
 Width: 64 mm  
 Length: 9m  
 Height: 9 mm  
 Weight: 7.5 Kg



# PLATFORMS



## FIRE RESISTANCE

Fire resistance class: **Bfl-S1** (corresponds to the French class **M1**). It conforms to the **EN13501-1+A1:2010** European standard.

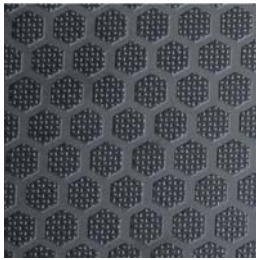

12mm black multi-ply anti-slip plywood

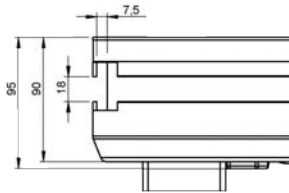

Internal structure of the multi-ply plywood platform and aluminium frame (EN AW6082T6)



## NEW PLATFORMS NEW UNIVERSAL ANGLES



**ROUND LEGS**  
48.3mm

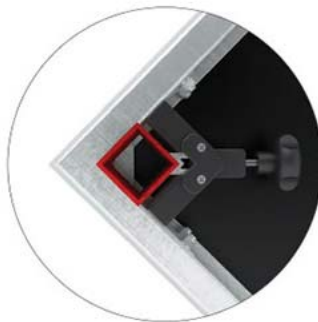

**SQUARE LEGS**  
50X50mm

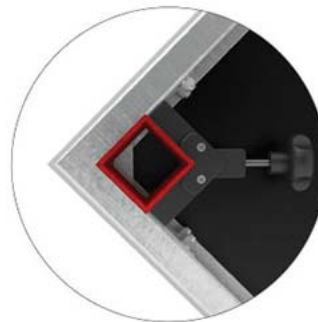

**SQUARE LEGS**  
60X60 mm



### PLTS-1x1

1m Platform x 1m non-slip 750 kg/m<sup>2</sup>-  
black - Delivered without legs

Code : H10370 279€<sup>Incl. VAT</sup>



Material:  
- Frame: Aluminium  
- Tray: 12mm multi-ply  
Thickness: 90 mm  
Allowable distributed load: 750 Kg/m<sup>2</sup>  
Weight: 16 Kg



### PLTS-2x1

2m Platform x 1m non-slip 750 kg/m<sup>2</sup>-  
black - Delivered without legs

Code : H10369 329€<sup>Incl. VAT</sup>



Material:  
- Frame: Aluminium  
- Tray: 12mm multi-ply  
Thickness: 90 mm  
Allowable distributed load: 750 Kg/m<sup>2</sup>  
Weight: 32 Kg



### PLTS-1x0.5

Platform 1x0.5m non-slip 750 kg/m<sup>2</sup>-  
black - Delivered without legs

Code : H10602 189€<sup>Incl. VAT</sup>



Material:  
- Frame: Aluminium  
- Tray: 12mm multi-ply  
Thickness: 90 mm  
Allowable distributed load: 750 Kg/m<sup>2</sup>  
Weight: 8 Kg



### PLTS-2x0.5

Platform 2x0.5m non-slip 750 kg/m<sup>2</sup>-  
black - Delivered without legs

Code : H10601 289€<sup>Incl. VAT</sup>



Material:  
- Frame: Aluminium  
- Tray: 12mm multi-ply  
Dimension : 2 m x 0.5 m  
Thickness: 90 mm  
Allowable distributed load: 750 Kg/m<sup>2</sup>  
Weight: 16 Kg



### PLTS-T1x1

1x1m anti-slip triangular platform 750 kg/m<sup>2</sup>-  
black - Delivered without legs

Code : H10603 399€<sup>Incl. VAT</sup>



Material:  
- Frame: Aluminium  
- Tray: 12mm multi-ply  
Dimension : 1 x 1 m  
Thickness: 90 mm  
Allowable distributed load: 750 Kg/m<sup>2</sup>  
Weight: 8 Kg



### PLTS-c1

Platform assembly clamp

Code : H10371 9€<sup>Incl. VAT</sup>



Material: Steel  
Thickness: 4 mm  
Weight: 0.42 Kg



### PLT-j1

Junction insert

Code : H10372 8€<sup>Incl. VAT</sup>



Compatible with PLTL and PLTS series  
Material: Steel  
Thickness: 3 mm  
Weight: 78 g



### PLT-j2

Leveling insert

Code : H10373 3.20€<sup>Incl. VAT</sup>



Compatible with PLTL and PLTS series  
Material: ABS  
Weight: 11 g



# PLATFORMS



**PLTS-ft4060**  
Telescopic square leg - 0.4 m to 0.6m - per unit

Code : H10374      32€<sup>Incl. VAT</sup>



Material: Aluminium  
Thickness: 2 mm  
Section: 60 x 60 mm  
Weight: 1.66 Kg



**PLTS-ft60100**  
Telescopic square leg - 0.6m to 1m - per unit

Code : H10375      39€<sup>Incl. VAT</sup>



Material: Aluminium  
Thickness: 2 mm  
Section: 60 x 60 mm  
Weight: 1.8 Kg



**PLTS-ft80140**  
Telescopic square leg - 0.8m to 1.4m - per unit

Code : H10403      47€<sup>Incl. VAT</sup>



Material: Aluminium  
Thickness: 2 mm  
Section: 60 x 60 mm  
Weight: 2.5 Kg



**PLTS-f20**  
Square leg 20 cm high - per unit

Code : H10376      7.50€<sup>Incl. VAT</sup>



Material: Aluminium  
Thickness: 2 mm  
Section: 60 x 60 mm  
Weight: 0.42 Kg



**PLTS-f40**  
Square leg 40 cm high - per unit

Code : H10377      10.50€<sup>Incl. VAT</sup>



Material: Aluminium  
Thickness: 2 mm  
Section: 60 x 60 mm  
Weight: 0.78 Kg



**PLTS-f60**  
Square leg 60 cm high - per unit

Code : H10378      14€<sup>Incl. VAT</sup>



Material: Aluminium  
Thickness: 2 mm  
Section: 60 x 60 mm  
Weight: 1.15 Kg



**PLTS-f80**  
Square leg 80 cm high - per unit

Code : H10379      17€<sup>Incl. VAT</sup>



Material: Aluminium  
Thickness: 2 mm  
Section: 60 x 60 mm  
Weight: 1.52 Kg



**PLTS-f100**  
Square leg 1 m high - per unit

Code : H10380      20€<sup>Incl. VAT</sup>



Material: Aluminium  
Thickness: 2 mm  
Section: 60 x 60 mm  
Weight: 1.89 Kg

**NEW****PLTS-FW24**

Square leg with caster - Height 24,5 cm

Code : H10858

33€<sup>Incl. VAT</sup>

Material: Aluminium  
 Thickness: 3 mm  
 Section: 60 x 60 mm  
 Wheel diameter: 100 mm  
 Weight: 1.41 Kg

**NEW****PLTS-FW40**

Square leg with caster - Height 40 cm

Code : H10859

37€<sup>Incl. VAT</sup>

Material: Aluminium  
 Thickness: 3 mm  
 Section: 60 x 60 mm  
 Wheel diameter: 100 mm  
 Weight: 1.69 Kg

**NEW****PLTS-FW60**

Square leg with caster - Height 60 cm

Code : H10860

42€<sup>Incl. VAT</sup>

Material: Aluminium  
 Thickness: 3 mm  
 Section: 60 x 60 mm  
 Wheel diameter: 100 mm  
 Weight: 2.06 Kg

**NEW****PLTS-FW80**

Square leg with caster - Height 80 cm

Code : H10861

47€<sup>Incl. VAT</sup>

Material: Aluminium  
 Thickness: 3 mm  
 Section: 60 x 60 mm  
 Wheel diameter: 100 mm  
 Weight: 2.43 Kg

**NEW****PLTS-FW100**

Square leg with caster - Height 100 cm

Code : H10862

50€<sup>Incl. VAT</sup>

Material: Aluminium  
 Thickness: 3 mm  
 Section: 60 x 60 mm  
 Wheel diameter: 100 mm  
 Weight: 2.80 Kg

**PLTS-fc2**

Connecting clamp for two square legs

Code : H10381

10€<sup>Incl. VAT</sup>

Material: Aluminium  
 Thickness: 5 mm  
 For section: 60 x 60 mm  
 Weight: 0.48 Kg

**PLTS-fc4**

Connecting clamp for four square legs

Code : H10382

22€<sup>Incl. VAT</sup>

Material: Aluminium/Steel  
 Thickness: 4,5 mm  
 For section: 60 x 60 mm  
 Weight: 0.48 Kg



# PLATFORMS



## PLTS-g1x1

Bar railing lg 1 m without fastener

Code : H10421

189€<sup>Incl. VAT</sup>



Material: Aluminium  
Diameter: 45.2 mm  
Weight: 7.9 Kg  
Length: 1 m  
Height: 1.2 m

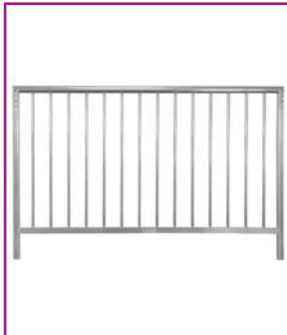

## PLTS-g2x1

Bar railing lg 2 m without fastener

Code : H10422

269€<sup>Incl. VAT</sup>



Material: Aluminium  
Diameter: 45.2 mm  
Weight: 12 Kg  
Length: 2 m  
Height: 1.2 m



## PLTS-gc1

Straight fastener for bar railing

Code : H10454

109€<sup>Incl. VAT</sup>



Straight fastener for guardrail:  
PLTS-g2x1  
PLTS-g1x1



## PLTS-gc2

Angled fastener for bar railing

Code : H10455

119€<sup>Incl. VAT</sup>



Angled fastener for guardrail:  
PLTS-g2x1  
PLTS-g1x1

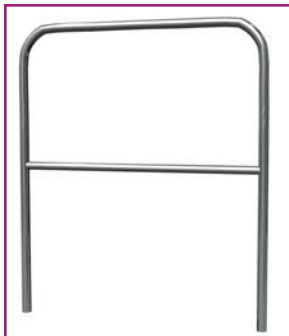

## PLTS-h1x1

Guardrail for platform of 1m length  
Supplied with fasteners

Code : H10392

129€<sup>Incl. VAT</sup>



Material: Aluminium  
Thickness: 2 mm  
Diameter: 35 mm  
Weight: 2.83 Kg  
Length: 1 m  
Height: 1.2 m



## PLTS-h2x1

Guardrail for platform of 2m length  
Supplied with fasteners

Code : H10391

149€<sup>Incl. VAT</sup>



Material: Aluminium  
Thickness: 2 mm  
Diameter: 35 mm  
Weight: 4.56 Kg  
Length: 2 m  
Height: 1.2 m



## PLTS-hc1

Platform guardrail fastener - per unit

Code : H10393

29€<sup>Incl. VAT</sup>



Guardrail fastener:  
PLTS-h1x1  
PLTS-h2x1  
Material: Steel  
Thickness: 4 mm  
Weight: 0.45 Kg



## PLTS-hc2

STAGE series guardrail junction clamp

Code : H10394

10€<sup>Incl. VAT</sup>



Junction clamp for guardrail  
PLTS-h1x1  
PLTS-h2x1  
Material: Steel  
Thickness: 5.5 mm  
Weight: 1.14 Kg

## EXAMPLES OF CONFIGURATIONS WITH 4 PLTS PLATFORMS-2x1

NOTE: From a height of 1 metre and to maintain full stability of the assembly, it is advisable to install the connecting clamps for 2 legs (PLTS-fc2) and 4 legs (PLTS-fc4).

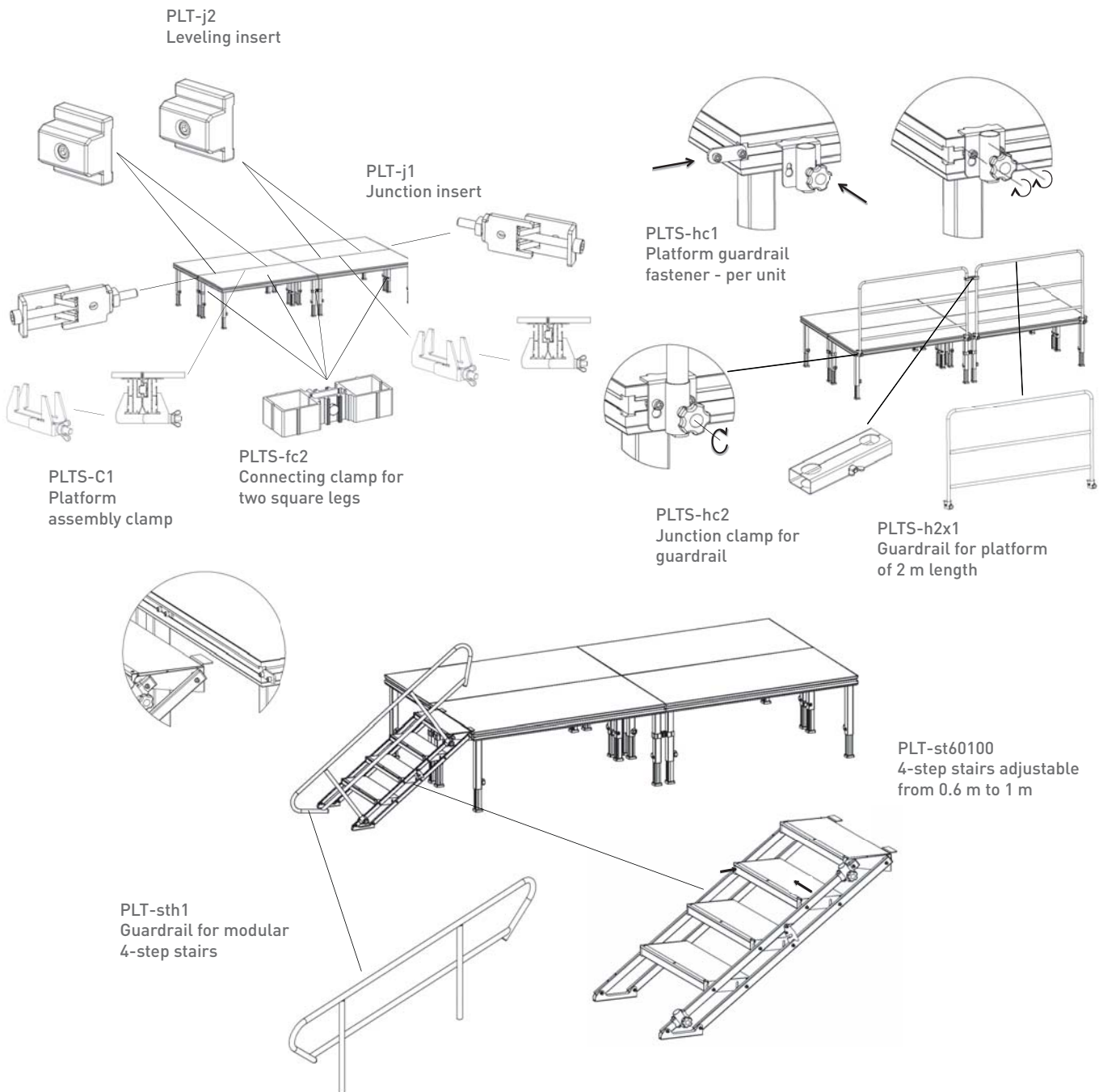

### ATTENTION ON THE SOIL CAPACITY

Soft ground can affect the safety of the installation.  
Please spread the loads evenly across the platform surface.

### ABOUT THE GUARDRAIL & STAIRS

A guardrail must be installed when the height is greater than 50 cm.  
Stairs less than or equal to 120 cm wide must have at least one handrail.

### CAUTION IN ACCORDANCE WITH THE NF E85-015 STANDARD

A maximum height of 150 cm is allowed. A guardrail must be installed if the height to be climbed is greater than 50 cm.  
These provisions are not exhaustive. For other prescriptions, obtain the standard quoted above.



# PLATFORMS



## BT-STAGE RS-PLF-2X1M

2x1m platform 750kg/m non-slip<sup>2</sup>- black - delivered without legs

Code : B03704 329€<sup>Incl. VAT</sup>



Material:  
 - Frame: Aluminium  
 - Tray: 12mm multi-ply  
 Thickness: 90 mm  
 Allowable distributed load: 750 Kg/m<sup>2</sup>  
 Weight: 32 Kg



## BT-STAGE RS PLF-2X0.5M

Platform 2x0.5m non-slip 750 kg/m<sup>2</sup>- black - Delivered without legs

Code : B03705 289€<sup>Incl. VAT</sup>



Material:  
 - Frame: Aluminium  
 - Tray: 12mm multi-ply  
 Thickness: 90 mm  
 Allowable distributed load: 750 Kg/m<sup>2</sup>  
 Weight: 16 Kg



## BT-STAGE RS PLF-1X1M

2x1m platform 750kg/m non-slip<sup>2</sup>- black - delivered without legs

Code : B03706 279€<sup>Incl. VAT</sup>



Material:  
 - Frame: Aluminium  
 - Tray: 12mm multi-ply  
 Thickness: 90 mm  
 Allowable distributed load: 750 Kg/m<sup>2</sup>  
 Weight: 18.3 Kg



## BT-STAGE-PLFCLAMP-BIG

Platform assembly clamp

Code : B03721 7.90€<sup>Incl. VAT</sup>



Material: Steel  
 Thickness: 4 mm  
 Weight: 0.42 Kg



## BT-STAGE-PLFCLAMP-SMALL (2pcs)

Code : B03720 14.90€<sup>Incl. VAT</sup>



Material: Steel  
 Thickness: 3 mm  
 Weight: 78 g each



## BT-STAGE-PLFLEVEL (6pcs)

Code : B03724 18.50€<sup>Incl. VAT</sup>



Leveling insert  
 Material: ABS  
 Weight: 11 g each





**BT-STAGE-LEGADJ-45/60CM**  
Telescopic round leg – 0.45m to 0.60m

Code : B03712 42.90€<sup>Incl. VAT</sup>



Material: Aluminium  
Thickness: 3 mm  
diameter: 48 mm  
Weight: 1.78 Kg



**BT-STAGE-LEGADJ-60/90 CM**  
Telescopic round leg – 0.60m to 0.90m

Code : B03713 49€<sup>Incl. VAT</sup>



Material: Aluminium  
Thickness: 3 mm  
diameter: 48 mm  
Weight: 2.37 Kg



**BT-STAGE-LEGFIX-20CM**  
Round leg, fixed height = 20cm, +/- 5cm adj.

Code : B03716 14.90€<sup>Incl. VAT</sup>



Material: Aluminium  
Adjustable leg: up to 5 cm  
Thickness: 3 mm  
diameter: 48 mm  
Weight: 0.30 Kg



**BT-STAGE-LEGFIX-40CM**  
Round leg, fixed height = 40cm, +/- 5cm adj.

Code : B03710 19€<sup>Incl. VAT</sup>



Material: Aluminium  
Adjustable leg: up to 5 cm  
Thickness: 3 mm  
diameter: 48 mm  
Weight: 0.49 Kg



**BT-STAGE-LEGFIX-60CM**  
Round leg, fixed height = 60cm, +/- 5cm adj.

Code : B03711 21.90€<sup>Incl. VAT</sup>



Material: Aluminium  
Adjustable leg: up to 5 cm  
Thickness: 3 mm  
diameter: 48 mm  
Weight: 0.72 Kg



**BT-STAGE-LEGFIX-80CM**  
Round leg, fixed height = 80cm, +/- 5cm adj.

Code : B03714 25€<sup>Incl. VAT</sup>



Material: Aluminium  
Adjustable leg: up to 5 cm  
Thickness: 3 mm  
diameter: 48 mm  
Weight: 0.82 Kg

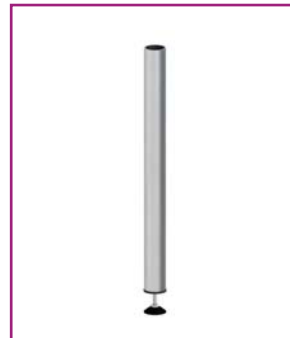

**BT-STAGE-LEGFIX-100CM**  
Round leg, fixed height = 100cm, +/- 5cm adj.

Code : B03715 29€<sup>Incl. VAT</sup>



Material: Aluminium  
Adjustable leg: up to 5 cm  
Thickness: 3 mm  
diameter: 48 mm  
Weight: 1.18 Kg



**BT-STAGE-LEGCLAMP-4**  
Connecting clamp for four round legs

Code : B03723 21€<sup>Incl. VAT</sup>



Material: Steel  
Thickness: 5 mm  
Weight: 1.6 Kg



**BT-STAGE-LEGCLAMP-2**  
Connecting clamp for two round legs

Code : B03722 9.50€<sup>Incl. VAT</sup>



Material: Steel  
Thickness: 5 mm  
Weight: 0.9 Kg



# PLATFORMS



## PLTL-1x1

Mobile platform 1m x 1m - 500 kg/m<sup>2</sup> - black Delivered without legs

Code : H10395

169€<sup>Incl. VAT</sup>



Material: Aluminium/multi-ply 12mm  
Dimensions 1 x 1 m  
Thickness: 55 mm  
Allowable distributed load: 500 Kg/m<sup>2</sup>  
Finish: Black  
Weight: 12.10 Kg



## PLT-j1

Junction insert

Code : H10372

8€<sup>Incl. VAT</sup>



Compatible with PLTL and PLTS series  
Material: Steel  
Thickness: 3 mm  
Weight: 78 g



## PLT-j2

Leveling insert

Code : H10373

3.20€<sup>Incl. VAT</sup>



Compatible with PLTL and PLTS series  
Material: ABS  
Weight: 11 g



## PLTL-Clip

Code : H10604

3.50€<sup>Incl. VAT</sup>



PLTL series platform support clip (to be combined with PLTL-CON)



## PLTL-Con

Code : H10605

1€<sup>Incl. VAT</sup>



PLTL series platform support junction connector (to be combined with PLTL-CLIP)

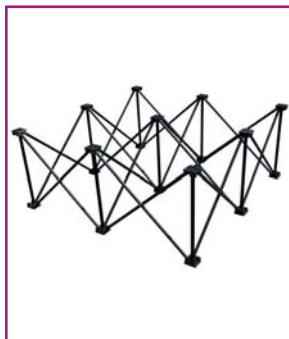

## PLTL-f20

Support for mobile platform 1 x 1m - height 20cm

Code : H10396

79€<sup>Incl. VAT</sup>



Material: Aluminium + ABS  
Finish: Black  
Operating height: 20 cm  
Folded height: 46.4 cm  
Weight: 2.6 Kg

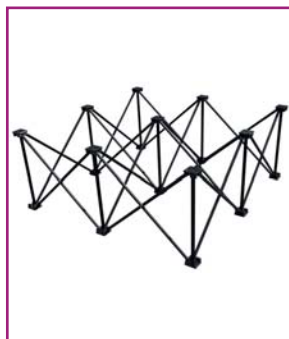

## PLTL-f40

Support for mobile platform 1 x 1m - height 40cm

Code : H10397

89€<sup>Incl. VAT</sup>



Material: Aluminium + ABS  
Finish: Black  
Operating height: 40 cm  
Folded height: 57.4 cm  
Weight: 3.5 Kg



## PLTL-f60

Support for mobile platform 1x1m - height 60cm

Code : H10398

99€<sup>Incl. VAT</sup>



Material: Aluminium + ABS  
Finish: Black  
Operating height: 60 cm  
Folded height: 72.6 cm  
Weight: 4.5 Kg



**BT-EASYSTAGE-1x1M**

Mobile platform 1m x 1m - 500 kg/m<sup>2</sup> - black Delivered without legs

Code : B03760 169€<sup>Incl. VAT</sup>



Material: Aluminium/multi-ply 12mm  
 Dimensions 1 x 1 m  
 Thickness: 55 mm  
 Allowable distributed load: 500 Kg/m<sup>2</sup>  
 Finish: Black  
 Weight: 12.10 Kg

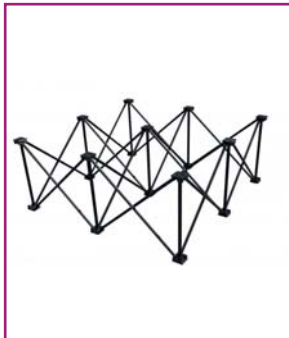

**BT-EASYSTAGE-RISER-20CM**

BT-EASYSTAGE platform support 1x1m - height 20cm

Code : B03761 79€<sup>Incl. VAT</sup>



Material: Aluminium + ABS  
 Finish: Black  
 Operating height: 20 cm  
 Folded height: 46.4 cm  
 Weight: 2.6 Kg

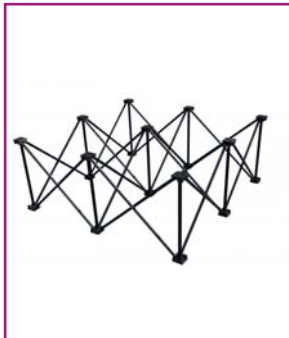

**BT-EASYSTAGE-RISER-40CM**

BT-EASYSTAGE platform support 1x1m - height 40cm

Code : B03762 89€<sup>Incl. VAT</sup>



Material: Aluminium + ABS  
 Finish: Black  
 Operating height: 40 cm  
 Folded height: 57.4 cm  
 Weight: 3.5 Kg

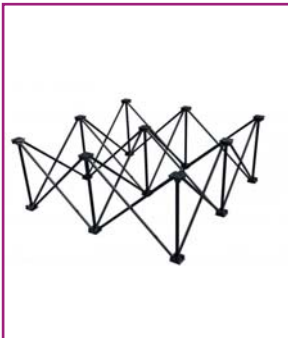

**BT-EASYSTAGE-RISER-60CM**

BT-EASYSTAGE platform support 1x1m - height 60cm

Code : B03763 99€<sup>Incl. VAT</sup>



Material: Aluminium + ABS  
 Finish: Black  
 Operating height: 60 cm  
 Folded height: 72.6 cm  
 Weight: 4.5 Kg



**BT-STAGE-PLFCLAMP-SMALL (2pcs)**

Code : B03720 16€<sup>Incl. VAT</sup>



Material: Steel  
 Thickness: 3 mm  
 Weight: 78 g each



**BT-STAGE-PLFLEVEL (6pcs)**

Code : B03724 18.50€<sup>Incl. VAT</sup>



Leveling insert  
 Material: ABS  
 Weight: 11 g each

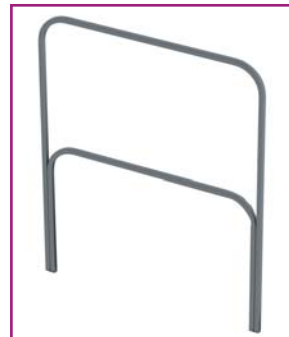

**PLTL-h1x1**

Guardrail for platform - length 1 m

Code : H10399 69€<sup>Incl. VAT</sup>



Material: Steel  
 Finish: Black  
 Section: 25 x 25 mm  
 Weight: 4.46 Kg

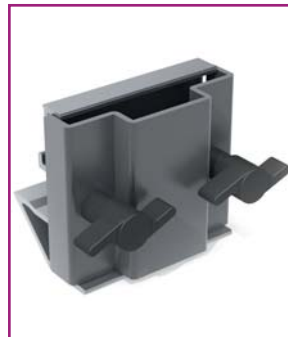

**PLTL-hc1**

Guardrail fastener for mobile platform - per unit

Code : H10400 19€<sup>Incl. VAT</sup>



Material: Steel  
 Finish: Grey  
 Weight: 0.45 Kg



# PLATFORMS



## PLTL-JU20x100

Finishing skirt for PLTL platform H20cm  
L105cm

Code : H10469 16€<sup>Incl. VAT</sup>

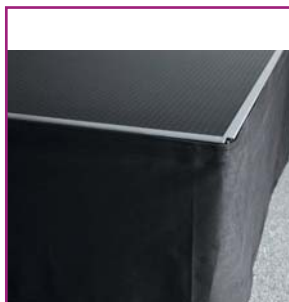

## PLTL-JU40x100

Finishing skirt for PLTL platform H40cm  
L105cm

Code : H10470 18€<sup>Incl. VAT</sup>



## PLTL-JU60x100

Finishing skirt for PLTL platform H60cm  
L105cm

Code : H10471 19€<sup>Incl. VAT</sup>

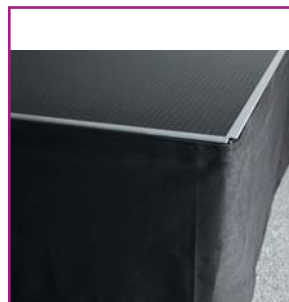

## PLTL-JU80x100

Finishing skirt for PLTL platform H80cm  
L105cm

Code : H10472 24€<sup>Incl. VAT</sup>



## PLTL-JU100x100

Finishing skirt for PLTL platform H100cm  
L105cm

Code : H10473 29€<sup>Incl. VAT</sup>



## PLTL-JU20x200

Finishing skirt for PLTL platform H20cm  
L205cm

Code : H10474 29€<sup>Incl. VAT</sup>



## PLTL-JU40x200

Finishing skirt for PLTL platform H40cm  
L205cm

Code : H10475 35€<sup>Incl. VAT</sup>

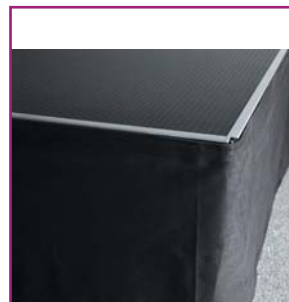

## PLTL-JU60x200

Finishing skirt for PLTL platform H60cm  
L205cm

Code : H10476 39€<sup>Incl. VAT</sup>



## PLTL-JU80x200

Finishing skirt for PLTL platform H80cm  
L205cm

Code : H10477 47€<sup>Incl. VAT</sup>



## PLTL-JU100x200

Finishing skirt for PLTL platform H100cm  
L205cm

Code : H10478 59€<sup>Incl. VAT</sup>



## PLTL-JUSUP

Fastening profile for PLTL-JU skirts L105cm

Code : H10479 15€<sup>Incl. VAT</sup>





**BT-STAGE-PLFRAIL-1M**  
Guardrail for platform of 1m length Supplied with fasteners

Code : B03742 125€<sup>Incl. VAT</sup>



Material: Aluminium  
Thickness: 2 mm  
Diameter: 35 mm  
Weight: 2.83 Kg  
Length: 1 m  
Height: 1.2 m



**BT-STAGE-PLFRAIL-2M**  
Guardrail for platform of 2m length Supplied with fasteners

Code : B03743 139.90€<sup>Incl. VAT</sup>



Material: Aluminium  
Thickness: 2 mm  
Diameter: 35 mm  
Weight: 3.49 Kg  
Length: 2 m  
Height: 1.2 m



**BT-EASY STAGE-TRANSPORT 1**  
BT-EASYSTAGE transport tray -1x1M.

Code : B03764 219€<sup>Incl. VAT</sup>



Transport tray for 15 BT-EASYSTAGE platforms -1x1M  
4 wheels  
2 nylon straps  
Weight: 25kg



**FLY6PLTL1**  
Flight case for 6 PLTL-1x1 with legs

Code : H10430 649€<sup>Incl. VAT</sup>



Flight case on wheels for transporting 6 PLTL-1x1 platforms, 6 legs and accessories



**BT-STAGE-TROLLEY**  
Platform transport trolley

Code : B03750 449€<sup>Incl. VAT</sup>



Transport trolley up to 20 platforms of 2m x1m  
Total length: 230cm  
Total height: 96cm  
Weight: 46 Kg



**PLT-TROLL**  
Platform transport trolley

Code : H10424 449€<sup>Incl. VAT</sup>



Transport trolley for 2x1 platforms



**PLT-BOARD**  
Platform transport trays

Code : H10423 259€<sup>Incl. VAT</sup>



2 transport trays  
4 braked castors per tray delivered without strap



# PLATFORMS



## PLT-st4060

Stairs adjustable from 0.4 m to 0.6 m - 2 steps

Code : H10383 429€<sup>Incl. VAT</sup>



Frames: Steel  
Finish: Black  
Step: 12mm multi-ply  
Weight: 16.2 Kg



## PLT-st60100

Stairs adjustable from 0.6 m to 1 m - 4 steps

Code : H10384 499€<sup>Incl. VAT</sup>



Frames: Steel  
Step: 12mm multi-ply  
Finish: Black  
Weight: 30 Kg



## PLT-st80140

Stairs adjustable from 0.8m to 1.4m - 5 steps

Code : H10404 569€<sup>Incl. VAT</sup>



Frames: Steel  
Step: 12mm multi-ply  
Finish: Black  
Weight: 37.46 Kg



## PLT-sth1

Guardrail for adjustable stairs

Code : H10385 129€<sup>Incl. VAT</sup>



Material: Aluminium  
Thickness: 2 mm  
Diameter: 35 mm  
Weight: 3.79 Kg  
Length: 2.3 m  
Height: 0.76 m



## BT-STAGE-STAIRS-20+40CM

Modular 2-step stairs - heights 20 and 40 cm

Code : B03740 229€<sup>Incl. VAT</sup>



Frames: Steel  
Steps: 12mm multi-ply  
Finish: Black  
Weight: 20.61 Kg



## BT-STAGE-STAIRS-60CM

Modular 1-step stairs - height 60 cm

Code : B03741 145€<sup>Incl. VAT</sup>



Frames: Steel  
Step: 12mm multi-ply  
Finish: Black  
Weight: 12.15 Kg



## BT-STAGE-STAIRS-80CM

Modular 1-step stairs - height 80 cm

Code : B03744 159€<sup>Incl. VAT</sup>



Frames: Steel  
Step: 12mm multi-ply  
Finish: Black  
Weight: 13.46 Kg



## BT-STAGE-STAIRS-RAIL3

Guardrail for stairs

Code : B03745 169€<sup>Incl. VAT</sup>



Material: Aluminium  
Thickness: 2 mm  
Diameter: 35 mm  
Weight: 3.4 Kg  
Length: 228.5 cm  
Support included



**PLT-stm20**

Modular 1-step stairs - height 20 cm

Code : H10386 169€<sup>Incl. VAT</sup>



Frames: Steel  
Step: 12mm multi-ply  
Finish: Black  
Weight: 9.61 Kg



**PLT-stm40**

Modular 2-step stairs - heights 20 and 40 cm

Code : H10387 229€<sup>Incl. VAT</sup>



Frames: Steel  
Steps: 12mm multi-ply  
Finish: Black  
Weight: 20.61 Kg



**PLT-stm60**

Modular 1-step stairs - height 60 cm

Code : H10388 145€<sup>Incl. VAT</sup>



Frames: Steel  
Step: 12mm multi-ply  
Finish: Black  
Weight: 12.15 Kg



**PLT-stm80**

Modular 1-step stairs - height 80 cm

Code : H10389 159€<sup>Incl. VAT</sup>



Frames: Steel  
Step: 12mm multi-ply  
Finish: Black  
Weight: 13.46 Kg



**PLT-sth2**

Guardrail for modular stairs - length 140cm

Code : H10390 169€<sup>Incl. VAT</sup>



Material: Aluminium  
Thickness: 2 mm  
Diameter: 35 mm  
Weight: 3.4 Kg



 **Hilec**

LIGHT & SOUND ACCESSORIES

**Premium Series**

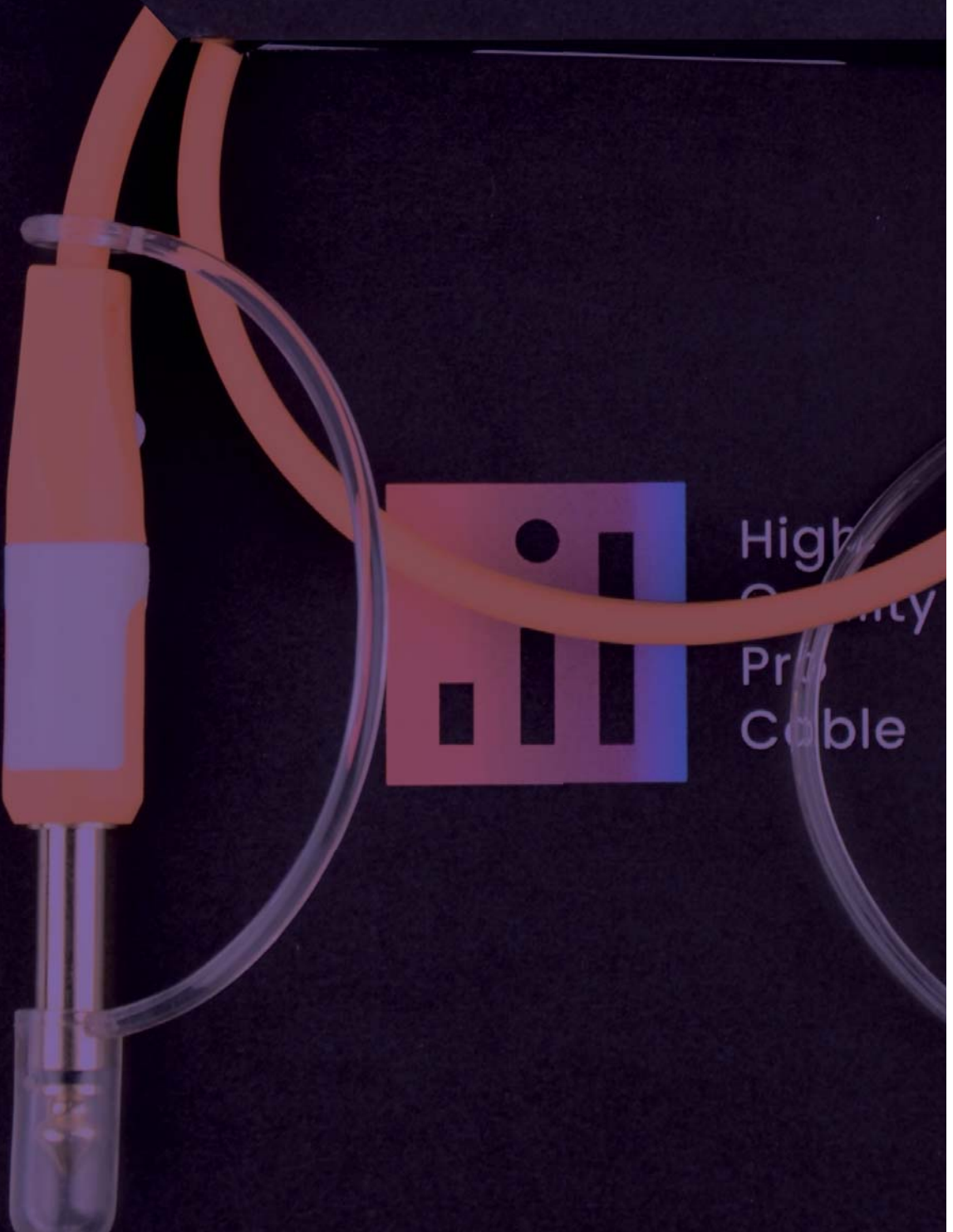

High  
Quality  
Pro  
Cable



# ACCESSORIES

LIGHTING STANDS AND LIGHT  
BRIDGE

SPEAKER AND MICROPHONES  
STANDS

MICROPHONE ACCESSORIES  
STANDS

WALL BRACKETS

PROTECTIVE COVERS

BATTERIES

GAFFAS

COLOURING

GOOSENECK LIGHTS

LINE AUDIO CABLES

MICROPHONE CABLES

SPEAKER CABLES

HYBRID AUDIO CABLES

DMX LIGHTING CABLES

HYBRID LIGHTING CABLES

POWER CABLES

USB CABLES

VIDEO CABLES

AUDIO CABLE

LIGHTING CABLE

ELECTRICAL CABLE

NEUTRIK CONNECTORS  
CONNECTORS

ADAPTERS

ELECTRICAL CONNECTORS

CONSTRUCTION ACCESSORIES

LOUDSPEAKERS AND FILTERS

LAMPS



# STANDS AND LIGHT BRIDGES



## POT-DJ

Sound and light bridge for DJ  
Length: 1.20 m - Height: 2.50 m

Code : H8257

159€<sup>Incl. VAT</sup>



Net weight: 18.5 Kg  
Light bridge height: 2.15 to 2.51 m  
Light bridge width: 2.4 m  
Stand height: 83 cm  
Stand width: 1.2 m  
Bars section: 30 x 30 mm  
Diameter of vertical tubes: 28 mm  
Number of holes: 12  
Maximum load: 50 Kgs distributed  
Materials:  
- Steel  
- ABS for the knobs  
Finish: matte black epoxy paint



## POT-BAG

POT-DJ light bridge bag  
With divider

Code : H8260

39€<sup>Incl. VAT</sup>



Quick fastener closure  
Material: 600x600D polyester  
3 separate spaces for the bars  
A large space for the upstanding bars of the stand  
Lateral strap  
Diameter of each space: 12 cm  
Small side length: 125 cm  
Large side length: 140 cm  
Width: 56 cm  
20 cm flap



## POT-330

Light bridge with steel structure  
Length: 3.00 m Height: 3.20 m

Code : H8259

199€<sup>Incl. VAT</sup>



Net weight: 21.6 Kg  
Light bridge height: 1.49 to 3,18 m  
Light bridge width:  
3 m (2x 1.5 m trusses)  
Number of holes: 10  
Supported load: 80 Kg distributed  
Dimension of each stand on the ground:  
1.2 m  
Diameter of the stand tubes: 28 mm  
Materials:  
- Steel  
- ABS for the wheels  
Finish: matte black epoxy paint

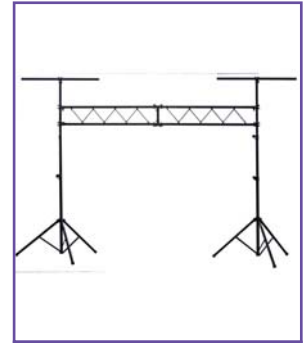

## LB-30

Light bridge: 2stand+truss,  
H3.25m - B4.2m -100kg

Code : B00755

149€<sup>Incl. VAT</sup>



Multifunctional aluminium economical bridge  
Consisting of 2 stands with T-bar and 2 bridge elements  
The 2 stands with T-bar can be used separately!  
Perfect for the mobile DJ; can be stored in any type of car!  
Distributed load up to 100kg!  
Distance between the stands = 3m  
Total width with installed T-bars = 4.2m  
Maximum height = 3.25m



## PID-100

Robust double crossbar stand, all-metal  
Height 3 m ø28

Code : H8252

49€<sup>Incl. VAT</sup>



Net weight: 5.3 Kg  
Height: from 1.48 to 3.13m  
Folded height: 1.23 m  
Tripod diameter: 1.4 m  
Supported load: 30 Kg  
Final tube diameter: 28 mm  
Tripod with double crossbars  
Materials:  
- Steel for tubes, tripod and crossbars  
- Rubber for the ends of the tubes  
- ABS for the knobs  
Finish: matte black epoxy paint



## PID-240

Stand + all-metal bar Height 2.40 m ø28

Code : H8253

59€<sup>Incl. VAT</sup>



Net weight: 6.7 Kg  
Height: from 1.49 to 2.40 m  
Folded height: 1.23 m  
Tripod diameter: 1.2 m  
Supported load: 30 Kg  
Diameter of the final tube: 28 mm  
Horizontal bar length: 1 m  
Single crossbar tripod  
Materials:  
- Steel for tubes, tripod and cross  
- Rubber for the ends of tubes  
- ABS for the knobs  
Finish: matte black epoxy paint



## LST-32

Light stand + T-bar, extendable - H3.18m/  
B1.5m/30kg

Code : B00756

59€<sup>Incl. VAT</sup>



Very stable folding lighting bracket with 100cm T-bar  
Robust design with 3 telescopic steel sections.  
Perfect for mounting all kinds of projectors and small lighting effects  
Maximum load: 30kg  
Net weight: 6.53 Kg  
Max. height: 3.18 m



## PID-380

3m stand with bar and maximum load of 80 kg

Code : H10489

75€<sup>Incl. VAT</sup>



Net weight: 11.2 Kg  
Height: from 1.87 to 3 m  
Folded height: 1.59 m  
Tripod diameter: 1.3 m  
Supported load: 80 Kg  
Diameter of the final tube: 35 mm  
Length of the horizontal bar: 1.5 m  
Horizontal bar diameter: 35 mm  
Tripod with double crossbars  
Materials:  
- Steel for tubes, tripod and crossbars  
- Rubber for the ends of tubes  
- ABS for the knobs  
Finish: matte black epoxy paint



**LS-64**  
Lighting stand – 3.10m / 80kg

---

Code : B00732      54,90€<sup>Incl. VAT</sup>

---



**Hilec**  
LIGHT & SOUND ACCESSORIES



**FLOOR4**  
Projector floor stand with M10 screw

---

Code : H9666      9,30€<sup>Incl. VAT</sup>

---



**Hilec**  
LIGHT & SOUND ACCESSORIES



**PROJECTOR FLOOR STAND**  
Projector floor stand with M10 screw

---

Code : B04947      6,90€<sup>Incl. VAT</sup>

---



**Hilec**  
LIGHT & SOUND ACCESSORIES



**STAND-FLOOR**  
Floor plate for projector

---

Code : H9116      27€<sup>Incl. VAT</sup>

---



**Hilec**  
LIGHT & SOUND ACCESSORIES

Multifunctional professional stand can be used as speaker stand or lighting stand  
Can be used as lighting stand with the TB-66 bar, available as an option.  
Max. load: 80kg



**PID1-BAG**  
Code : H10012  
13,90 €<sup>Incl. VAT</sup>

Customized for PID-100 and PID-240 stands  
Maximum diameter: 16 cm  
Maximum height: 125 cm



**PID2-BAG**  
Code : H10013  
19,90 €<sup>Incl. VAT</sup>

Customized for PID-100 and PID-240 stand  
Maximum diameter: 20 cm  
Maximum height: 125 cm



**BRE-120**  
Code : H8256  
14,00 €<sup>Incl. VAT</sup>

Internal diameter of the stand adaptor: 28 mm  
Bar length: 1.20 m  
Bar section: 30 x 30 mm  
Number of holes: 4  
Materials: Steel and ABS for the knob  
Finish: matte black epoxy paint  
Net weight: 1.6 Kg



**BRE-50**  
Code : H8845  
65,00 €<sup>Incl. VAT</sup>

Length: 1.5 m / round section: 50 mm  
Stand adaptor for 35 mm stands  
Weight: 3.6 kg



**TB-66**  
Code : B00733  
12,90 €<sup>Incl. VAT</sup>

T-Bar for LS-64  
Mounting of up to 12 projectors  
Equipped with fixing hardware  
Length = 150cm  
Designed for mounting on standard 35mm mast top



**TB-64**  
Code : B00743  
12,90 €<sup>Incl. VAT</sup>

Steel T-Bar (30x30mm)  
Mounting up to 8 projectors  
Equipped with fixing hardware  
Length = 120cm  
Planned for mounting on standard 35mm mast top



**T 150**  
Code : B02616  
35,90 €<sup>Incl. VAT</sup>

Truss adaptor for 150mm truss  
Suitable for all our stands that have a ø35mm mast top



**Hilec**  
LIGHT & SOUND ACCESSORIES



**DJ-TRUSS 200**  
Code : B00739  
79,00 €<sup>Incl. VAT</sup>

Very strong and compact steel truss, section 150  
Length = 2m



**DJ-TRUSS 150**  
Code : B00740  
59,00 €<sup>Incl. VAT</sup>

Very strong and compact steel truss, section 150  
Length = 1.5m



**SST-20**  
Code : H8262  
10,00 €<sup>Incl. VAT</sup>

For PT20-150 truss only  
Bar length: 21 cm  
Section of the bar: 30 x 20 mm  
Internal diameter of the stand adaptor: 28 mm  
M8 screw for fastening the truss  
Finish: matte black epoxy paint  
Weight: 0.40 Kg



**NEW**  
**SST-22**  
Code : H10873

Stand adaptor with 35mm tube for 220 truss



# SPEAKER STANDS



**SS-POWERLIFT**  
Speaker stand, expandable 1.80m / 60kg

Code : B00749 89€<sup>Incl. VAT</sup>



Special locking mechanism for safe and reliable operation: no need for a safety pin!  
Spring mechanism with air cushion: Prevents the speaker from falling quickly  
Allows easy height adjustment while there is a heavy speaker on the stand, even with one hand.  
Load capacity: 60kgs Max.



**SS-AIR**  
Speaker stand, expandable pneumatic brake - 1.80m / 60kg

Code : B00734 55.90€<sup>Incl. VAT</sup>



Professional aluminium speaker stand, equipped with a special air cushion system!  
To avoid any accident, the speaker goes down slowly instead of "falling" on its base  
Very stable construction with metal base  
Low minimum height: facilitates placement of the speaker on the stand!  
Max load: 60kg



**CAB-200**  
All-metal speaker stand Height 2 m

Code : H8245 32.90€<sup>Incl. VAT</sup>



Net weight: 4.5 Kg  
Height: from 1.41 to 2.10 m  
Folded height: 1.08 m  
Tripod diameter: 1.2 m  
Supported load: 40Kg  
Diameter of the final tube: 35 mm  
Tripod with single crossbars  
Materials:  
Steel for tubes and tripod  
Rubber for the ends of tubes  
ABS for the knobs  
Finish: matte black epoxy paint



**SS-59**  
Speaker stand, extendable - 2.05m / 40kg

Code : B00737 42.90€<sup>Incl. VAT</sup>



Professional speaker stand  
Very stable construction with metal base  
Low minimum height: facilitates placement of the speaker on the stand  
Max load: 40kg



**CAB-100**  
Speaker stand with small tripod diameter

Code : H8246 29.90€<sup>Incl. VAT</sup>



Net weight: 3.1 Kg  
Height: from 0.92 to 1.40 m  
Folded height: 76 cm  
Tripod diameter: 0.70 m  
Supported load: 30 Kg  
Tube diameter: 35 mm  
Materials:  
- Steel for tubes and tripod  
- Rubber for the ends of tubes  
- ABS for the wheels  
Finish: matte black epoxy paint



**TUB-LINK**  
83 to 123cm telescopic pole with pin

Code : H9105 24.90€<sup>Incl. VAT</sup>



Telescopic pole  
Diameter of the upper part: 35mm  
Diameter of the lower part: 35mm  
Height: 83 cm to 123 cm  
Load capacity: 30kg



**SPEAKER POLE (M20 thread)**  
Telescopic pole

Code : B00659 19.90€<sup>Incl. VAT</sup>



Telescopic pole  
Diameter of the upper part: 35mm  
Bottom thread: 20mm  
Height: 76 cm to 1.16 m  
Load capacity: 30kg



**VP-130**  
Telescopic pole

Code : B00655 7.90€<sup>Incl. VAT</sup>



This special stand offers you the possibility to place a speaker from 0.7m to 1.3m



**TWIN SPEAKER  
BRACKET Mk2**  
Adapter for 2 speakers on one stand

Code : B00763 19.90€<sup>Incl. VAT</sup>



Adapter for installing 2 speakers on a single stand.  
The distance between the speakers can be adjusted between 32 and 51cm.  
Solid steel construction.  
For speakers up to 2x 20kg  
Adapter diameter: D=35mm



**FORK**  
Separate 42 cm double 35mm adapter for speakers up to 40Kg

Code : H7916 33.90€<sup>Incl. VAT</sup>



Adapter for the installation of 2 speakers on a single stand.  
Distance between speakers: 42cm.  
Solid steel construction.  
For speakers up to 40 Kg  
Diameter of the adapter: D=35mm



**CABSET**  
Set of 2 speaker stands + 1 bag

Code : H10069 69.90€<sup>Incl. VAT</sup>



**STANDS:**  
Net weight: 4.7 Kg  
Height: from 1.23 to 2.02 m  
Folded height: 1.04 m  
Tripod diameter: 1.2 m  
Supported load: 40 Kg  
Diameter of the final tube: 35 mm  
Tripod with single crossbars  
Materials:  
- Steel for tubes and tripod  
- Rubber for the ends of tubes  
- ABS for the knobs  
Finish: matte black epoxy paint  
**COVER:**  
Slide-fastener (zipper)  
Customized for CAB-100 and CAB-200 stands  
Divider  
Adjustable strap  
Maximum diameter: 20 cm  
Maximum height: 110 cm



**CAB1-BAG**  
Bag for 1 speaker stand

Code : H10010 13.90€<sup>Incl. VAT</sup>



Customized for Audiophony CAB-100 and CAB-200 stands  
Adjustable strap  
Maximum diameter: 16 cm  
Maximum height: 110 cm



**CAB2-BAG**  
Bag for 2 speaker stands

Code : H10011 19€<sup>Incl. VAT</sup>



Customized for Audiophony CAB-100 and CAB-200 stands  
Divider  
Adjustable strap  
Maximum diameter: 20 cm  
Maximum height: 110 cm



**BAG-STAND**  
Nylon bag for stands intended for lighting effects or sound system elements

Code : B00741 9.90€<sup>Incl. VAT</sup>



Stylish and durable nylon bag for stands intended for lighting effects or sound system elements  
Perfect for SS-59, SS-AIR, LST-32 stands



# MICROPHONE STANDS



## MIC-200T

Microphone stand with telescopic boom with heavy baseplate - adjustable height

Code : H8236 56.10€<sup>Incl. VAT</sup>



Microphone stand with telescopic boom with heavy baseplate  
 Net weight: 5.3 Kg  
 Height: from 92 cm to 1.52 m  
 Baseplate diameter: 25.5 cm  
 Thread at the boom tip: 3/8"  
 Boom length: 55 to 90 cm  
 Materials:  
 - Aluminium for the boom hinge  
 - Steel for the tubes and baseplate  
 - Rubber for the ends of tubes  
 - ABS for the knobs and the boom tip  
 Finish: matte black epoxy paint



## MIC-100

All-metal microphone boom tripod with adjustable height

Code : H8235 48.90€<sup>Incl. VAT</sup>



Net weight: 2.9 Kg  
 Height: from 1.05 to 1.60 m  
 Tripod diameter: 72 cm  
 Thread at the end of the pole: 3/8"  
 Boom length: 74 cm  
 Materials:  
 - Aluminium for the tripod and boom hinge  
 - Steel for the tubes  
 - Rubber for the ends of tubes  
 - ABS for the knobs and the pole tip  
 Finish: matte black epoxy paint



## MS-26PRO

Adjustable height all-metal pole tripod

Code : B00765 41.90€<sup>Incl. VAT</sup>



Professional microphone stand with adjustable boom  
 Robust and resistant magnesium base  
 Very good stability  
 Boom length: 64cm  
 Thread at the end of the pole: 3/8"



## MIS10

Microphone stand + bag

Code : H10068 24.90€<sup>Incl. VAT</sup>



STAND  
 Net weight: 1.8 Kg  
 Height: from 95 cm to 1,48 m  
 Tripod diameter: 70 cm  
 Thread at the end of the pole: 3/8"  
 Length of the pole: 77 cm  
 Materials:  
 - ABS for the tripod and boom hinge  
 - Steel for tubes  
 - Rubber for the ends of tubes  
 - ABS for the knobs and the pole tip  
 Finish: matte black epoxy paint  
 COVER  
 Slide-fastener (zipper)  
 Material: Polyester  
 Customized for Audiophony MIC-100T and MIS10 microphone stands  
 Maximum diameter: 10 cm  
 Maximum height: 110 cm



## MS-27

Straight universal microphone stand

Code : B00766 30.90€<sup>Incl. VAT</sup>



Straight universal microphone stand  
 Base in thick cast iron, covered with a beautiful layer of plastic.  
 Base diameter: 25cm  
 Thread at the end of the pole: 3/8"



## MS-25

Adjustable height all-metal pole tripod

Code : B00764 23.90€<sup>Incl. VAT</sup>



Microphone stand with adjustable swivel boom  
 Solid nylon base  
 Very good stability  
 Pole length: 64cm  
 Thread at the end of the pole: 3/8"



## MIC5-BAG

Bag for 5 microphone stands

Code : H10009 35.20€<sup>Incl. VAT</sup>



Customized for the Audiophony MIC-100 stand  
 5 separate spaces  
 Lateral strap  
 Max. diameter of each space: 10 cm  
 Height of each space: 100 cm  
 28 cm flap



## MIC1-BAG

Bag for 1 microphone stand

Code : H10008 10.10€<sup>Incl. VAT</sup>



Customized for the Audiophony MIC-100 stand  
 Side handle  
 Maximum diameter: 10 cm  
 Maximum height: 104 cm



### BAG-MIC

Nylon bag for microphone stand

Code : B00742

5.90€<sup>Incl. VAT</sup>



Stylish and durable nylon bag for microphone stand  
Perfect for MS-25 and MS-26PRO stands



### TMIC100

Flexible arm for microphone with XLR cable and table mounting

Code : H10458

44.50€<sup>Incl. VAT</sup>



### TMIC-20

Microphone table stand with heavy base - height 30 cm

Code : H8232

30.50€<sup>Incl. VAT</sup>



Net weight: 3.3 Kg  
Height: 30 cm  
Diameter of the base: 22 cm  
Thread at the end of the pole: 3/8"  
Length of the pole: 74 cm  
Materials:  
Steel  
Rubber on the base  
ABS for the knob and the boom tip  
Finish: matte black epoxy paint



### JB50

Microphone table stand with heavy base - microphone thread : 3/8"

Code : B00702

19€<sup>Incl. VAT</sup>



Microphone table stand  
Heavy base  
Robust design  
Telescopic microphone arm:  
Min. length: 320mm  
Max. length: 565mm



### TMIC-10

Microphone table stand - height 18 cm

Code : H8231

15.10€<sup>Incl. VAT</sup>



Net weight: 0.24 Kg  
Height: 18 cm  
Tripod diameter: 26 cm  
Thread at the end of the pole: 3/8"  
Materials:  
Steel  
Rubber for the ends of tubes  
Finish: matte black epoxy paint



### JB52

Microphone table stand, thread: 3/8"

Code : B00700

12.90€<sup>Incl. VAT</sup>



Microphone table stand.  
Innovative design, fully foldable.  
thread: 3/8"  
Height: 170mm



### JB55

Straight table base for microphone

Code : B00704

19.90€<sup>Incl. VAT</sup>



Straight table base (24 cm to 40 cm)



### JB85

Gooseneck 50cm for microphones

Code : B00709

9.90€<sup>Incl. VAT</sup>



Flexible gooseneck, length 50 cm



### JB88

Base for gooseneck (JB85)

Code : B00710

4.49€<sup>Incl. VAT</sup>



# MICROPHONE ACCESSORIES



**JB70**  
Universal clamp for quick-attaching microphone

Code : B00707 4.29€<sup>Incl. VAT</sup>



Universal clamp for quick-attaching microphone



**JB71**  
Universal clamp for microphone

Code : B00412 4.90€<sup>Incl. VAT</sup>



Universal clamp for micro  
Soft material: does not scratch



**A415**  
Spring microphone clamp

Code : H0180 1.60€<sup>Incl. VAT</sup>



Material: ABS  
Maximum opening diameter: 40mm



**A602**  
Insert microphone clamp

Code : H1078 1.50€<sup>Incl. VAT</sup>



Material: Rubber  
Supplied with 3/8 to 5/8 insert



**PM38**  
3/8 rubber microphone clamp

Code : H9929 4.20€<sup>Incl. VAT</sup>



Material: Rubber  
3/8 brass insert



**AD38**  
Microphone clamp adapter 3/8 to 5/8

Code : H9930 1.30€<sup>Incl. VAT</sup>



**JB75**  
Metal reduction 5/8 "-3/8" (10 pieces)

Code : B00711 5.50€<sup>Incl. VAT</sup>

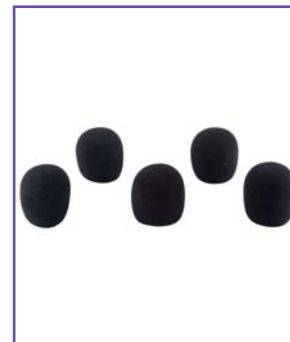

**WINDSCREEN BLACK**  
Set of 5 black foams.

Code : B00415 4.90€<sup>Incl. VAT</sup>



**WINDSCREEN COLOURED**  
Set of 5 foams in different colors.

Code : B00416 4.29€<sup>Incl. VAT</sup>



**WS-3**  
Black microphone windscreen

Code : H3686 2.40€<sup>Incl. VAT</sup>





# STANDS



## KB4

Keyboard stand with double crossbars - Magnesium series

Code : H9663 38€<sup>Incl. VAT</sup>

**Hilec**  
LIGHT & SOUND ACCESSORIES

Net weight: 4.5 Kg  
Height: from 58 to 98 cm  
Width: from 80 to 82 cm  
Length of the upper tubes: 40 cm  
Supported load: 50 Kg max.  
Locking brake  
Materials:  
- Steel for the tubes and bars  
- Rubber for the ends of tubes  
Finish: anthracite epoxy paint



## KB-UNO

Keyboard stand

Code : H8226 24,90€<sup>Incl. VAT</sup>

**Hilec**  
LIGHT & SOUND ACCESSORIES

Net weight: 2.2 Kg  
Height: from 60 cm to 93 cm  
Distance of horizontal crossbars: from 32 cm to 80 cm  
Crossbar length: 30 cm  
Materials:  
- Steel for the stand  
- Rubber for the ends of tubes  
Maximum load: 25 Kg  
Finish: matte black epoxy paint



## KB-ROLL

Controller or keyboard stand with integrated trolley.

Code : H8224 74,80€<sup>Incl. VAT</sup>

**Hilec**  
LIGHT & SOUND ACCESSORIES

Net weight: 6.1 Kg  
Height: from 60 cm to 120 cm  
Distance of horizontal crossbar: from 32 cm to 87 cm  
Length of crossbar: 40 cm  
Materials:  
- Steel for the stand  
- ABS for retractable bars  
- Rubber for the ends of tubes  
- Nylon for the strap  
Maximum load: 50 Kg  
Finish: matte black epoxy paint



## KB-BAG

Bag for 1 controller or keyboard stand

Code : H10007 20€<sup>Incl. VAT</sup>

**Hilec**  
LIGHT & SOUND ACCESSORIES

Customized for Audiophony KB-ROLL, KB-UNO and KB4 stands  
Side handle  
Maximum width: 50 cm  
Maximum height: 100 cm  
Maximum thickness of the folded stand: 5 cm



## KB-EXT70

Extension for control stand - inclined

Code : H8227 26,20€<sup>Incl. VAT</sup>

**Hilec**  
LIGHT & SOUND ACCESSORIES

Net weight: 1.5 Kg  
Height: 24 cm  
Crossbar incline: 70° compared to the vertical  
Crossbar length: 30 cm  
Materials:  
- Steel for the stand  
- ABS for the knob  
- Rubber for the ends of tubes  
Finish: matte black epoxy paint



## KB-EXT90

Extension for control stand - straight

Code : H8228 28,50€<sup>Incl. VAT</sup>

**Hilec**  
LIGHT & SOUND ACCESSORIES

Net weight: 1.5 Kg  
Height: 24 cm  
Crossbar incline: horizontal  
Length of the traverse: 30 cm  
Materials:  
- Steel for the support  
- ABS for the knob  
- Rubber for the ends of tubes  
Finish: matte black epoxy paint



## DJ4

Magnesium series DJ control stand

Code : H9665 249€<sup>Incl. VAT</sup>

**Hilec**  
LIGHT & SOUND ACCESSORIES

Net weight: 15 Kg  
Height: from 68 to 92 cm  
Dimensions of the main tray: 45 x 100 cm  
Dimensions of the top tray: 30 x 60 cm  
Materials:  
- Steel for the tubes, bars and trays  
- ABS for tube tips and knobs  
Finish: anthracite epoxy paint



# SUPPORTS



## MEDIAstage1

Aluminium stand for mobile phones

Code : H10495 16.90€<sup>Incl. VAT</sup>



## MEDIAstage2

Aluminium stand with clamp for mobile phones and tablets

Code : H10496 31.90€<sup>Incl. VAT</sup>



## MEDIAstage3

Aluminium stand with 1 suction cup for tablets and smartphones

Code : H10494 32.90€<sup>Incl. VAT</sup>



## MEDIAstage4

Aluminium stand with double suction cups for tablets and smartphones

Code : H10493 33.90€<sup>Incl. VAT</sup>



For 3.5 to 5.5 inch phones  
Material: Aluminium  
Dimensions (WxHxD): 38 x 381 x 25 mm  
Folded dimensions (WxHxD):  
38 x 168 x 25 mm  
Arm length (unfolded): 238 mm  
Stand depth: 17,5 mm  
Stand height: 57 to 89 mm  
Weight: 130 grams

Suitable for smartphones and tablets  
from 4 to 11 inches  
Aluminium structure, 500g  
Maximum load 1 kg

Suitable for smartphones and tablets  
from 4 to 11 inches  
Aluminium structure, 500g  
Maximum load 1 kg

Suitable for smartphones and tablets  
from 4 to 11 inches  
Aluminium structure, 500g  
Maximum load 1 kg



## MEDIAstage5

Aluminium stand with 1 suction cup for mobile phones and tablets

Code : H10654 23.90€<sup>Incl. VAT</sup>



## MEDIAstage6

Aluminium stand for mobile phones and tablets

Code : H10655 23.90€<sup>Incl. VAT</sup>



## MEDIA2

Tablet holder to attach to microphone stand

Code : H10457 11.90€<sup>Incl. VAT</sup>



## TABLET HOLDER

Universal tablet holder for microphone stand. Screens from 7" to 11"

Code : B00767 9.90€<sup>Incl. VAT</sup>





**LAPTOP STAND**  
Universal computer stand

Code : B03195 39€<sup>incl. VAT</sup>



**MEDIA4**  
Magnesium series adjustable multimedia stand

Code : H9664 74.90€<sup>incl. VAT</sup>



**MEDIA3**  
Laptop stand with table mounts

Code : H10456 31.90€<sup>incl. VAT</sup>



Universal laptop stand  
Easily attaches to the vertical parts of your flight bag  
Easily attaches to a table  
Adaptable in many ways, thanks to intelligent design:  
Adaptable width, thanks to 4 expansion adapters: 235mm to 285mm  
Adaptable height: 250mm to 380mm  
Durable and stable metal design in black finish.  
All accessories (buttons, table/rack clamps, extension adapter) are included.  
Weight: 2.3kg (all included)  
Max. height: 380mm  
Minimum height: 250mm  
Max. width: 285mm  
Min. width: 235mm

Net weight: 2.8 Kg  
Height: from 17 to 30 cm  
Width (from the top): from 29 to 39 cm  
Materials:  
- Steel  
- ABS for the knobs and bar tips  
Finish: anthracite epoxy paint



<b>A</b>	SUPPLAT Code : H7903	Plastic support plate for 36 mm stand Platinum 180 x 120 mm	10.20€ <sup>incl. VAT</sup>		<b>B</b>	EYE-10 Code : H8843	Eyebolt without M10 screws - 230 Kg	5.90€ <sup>incl. VAT</sup>	
<b>C</b>	EYE-08 Code : H8842	Eyebolt without M8 screws - 140 Kg	5.20€ <sup>incl. VAT</sup>		<b>D</b>	M10 Eyebolt (4 pcs) Code : B00658	Eyebolt without M10 screws (4 pcs)	7.49€ <sup>incl. VAT</sup>	
<b>E</b>	M8 Eyebolt (4 pcs) Code : B00657	Eyebolt without M8 screws (4 pcs)	7.49€ <sup>incl. VAT</sup>		<b>F</b>	H00K-12 Code : H8844	Harp shackle 12 mm - 500 Kg	7.70€ <sup>incl. VAT</sup>	
<b>G</b>	CPL-35 Code : H8248	Cup with M8 screw for 35 mm stand	7.80€ <sup>incl. VAT</sup>		<b>H</b>	C-35 Code : H8247	Metal speaker baseplate	9.50€ <sup>incl. VAT</sup>	
<b>I</b>	C-36 Code : H1077	Metal speaker base	6.60€ <sup>incl. VAT</sup>		<b>J</b>	CPL-12 Code : H3239	Super reinforced cup Diameter 12 cm	25€ <sup>incl. VAT</sup>	
<b>K</b>	CO-12 Code : B02645	Reinforced cup ø12cm.	7.90€ <sup>incl. VAT</sup>		<b>L</b>	CPL-28 Code : H8255	Cup with M8 screw For 28 mm stand	6.50€ <sup>incl. VAT</sup>	
<b>M</b>	VELCRO-30 Code : H8876	VELCRO 25 x 300 mm strap	0.90€ <sup>incl. VAT</sup>		<b>N</b>	VELCRO-60 Code : H8877	VELCRO 45 x 600 mm strip	2.30€ <sup>incl. VAT</sup>	
<b>O</b>	COLL520 Code : H10442	Reusable clamping collar 48x200mm-100 pieces	13.50€ <sup>incl. VAT</sup>		<b>P</b>	COLL825 Code : H10443	Reusable clamping collar 76x250 mm-100 pieces	20.70€ <sup>incl. VAT</sup>	



# WALL BRACKETS



<b>A</b>	SUPWALL Code : H9104	Adjustable wall mount for speakers up to 40Kg	26,80€ <sup>incl. VAT</sup>
<b>C</b>	BS/6-1 Code : H7906	Adjustable wall mount for speakers up to 20kg	67,90€ <sup>incl. VAT</sup>
<b>E</b>	WB-L30 Code : B00761	Wall mount 30cm, 40kg	23,90€ <sup>incl. VAT</sup>
<b>G</b>	iLINE24sup Code : H10773	Adjustable wall bracket for iLINE23 and iLINE43	69,00€ <sup>incl. VAT</sup>
<b>I</b>	iLINEbase Code : H10760	Floor bracket for iLINE83B and iLINESPACE60	109,00€ <sup>incl. VAT</sup>
<b>K</b>	iLINE43sup Code : H10755	Wall bracket for iLINE43 column	35,00€ <sup>incl. VAT</sup>
<b>M</b>	iLINE24sup Code : H10773	Adjustable wall bracket for iLINE23 and iLINE43	69,00€ <sup>incl. VAT</sup>
<b>O</b>	CUB-Wall1 Code : H10730	Wall bracket for CUBsat4	10€ <sup>incl. VAT</sup>
<b>Q</b>	CUB-Truss1 Code : H10732	Suspension support for CUBsat4	39€ <sup>incl. VAT</sup>
<b>S</b>	SUP-AC08WH Code : H9599	ACUTE08 monitor hanging bracket - white	39€ <sup>incl. VAT</sup>
<b>U</b>	SUPS6/WH Code : H9706	Mounting bracket for S6 satellite - white	36,00€ <sup>incl. VAT</sup>
<b>W</b>	SUPS8/WH Code : H9708	Mounting bracket for S8 satellite - white	39,00€ <sup>incl. VAT</sup>
<b>Y</b>	SUPS10/WH Code : H9710	Mounting bracket for S10 satellite - white	39,00€ <sup>incl. VAT</sup>
<b>A1</b>	Bracket for SC-12 Code : B09185	Robust Foldable Stand for SC-12 Speaker	99,00€ <sup>incl. VAT</sup>

<b>B</b>	BS/5-1 Code : H7907	Articulated wall baseplate for large speakers up to 40 Kg	71,10€ <sup>incl. VAT</sup>
<b>D</b>	WB-L20 Code : B00760	Wall mount 20cm, 40kg	23,90€ <sup>incl. VAT</sup>
<b>F</b>	BYR Code : H1075	Wall mount for rotating speaker	39,10€ <sup>incl. VAT</sup>
<b>H</b>	iLINEspace60 Code : H10759	Increase height by 60cm for iLINE83B with stackable connector base	89,00€ <sup>incl. VAT</sup>
<b>J</b>	iLINE83sup Code : H10757	Wall bracket for iLINE83 column	39,00€ <sup>incl. VAT</sup>
<b>L</b>	iLINE23sup Code : H10753	Wall bracket for iLINE23 column	29,00€ <sup>incl. VAT</sup>
<b>N</b>	CUB-BRACKET Code : H10666	Bumper suspension for mini line array head	89,00€ <sup>incl. VAT</sup>
<b>P</b>	CUB-Pole1 Code : H10731	Foot support for CUBsat4	59,00€ <sup>incl. VAT</sup>
<b>R</b>	SUP-AC08NO Code : H9598	ACUTE08 monitor hanging bracket - black	39€ <sup>incl. VAT</sup>
<b>T</b>	SUPS6/NO Code : H9705	Hanging bracket for S6 satellite - black	36,00€ <sup>incl. VAT</sup>
<b>V</b>	SUPS8/NO Code : H9707	Mounting bracket for S8 satellite - black	39,00€ <sup>incl. VAT</sup>
<b>X</b>	SUPS10/NO Code : H9709	Mounting bracket for S10 satellite - black	39,00€ <sup>incl. VAT</sup>
<b>Z</b>	Bracket for SC-08 Code : B09184	Robust foldable stand for SC-08 speaker	74,90€ <sup>incl. VAT</sup>
<b>B1</b>	Bracket for SC-15 Code : B09186	Robust Foldable Stand for SC-15 Speaker	99,00€ <sup>incl. VAT</sup>

# PROTECTIVE COVERS



<b>A</b>	COV-MOJ0500LINE Code : H10867	Protective cover for MOJ0500LINE subwoofer	99€ <sup>incl. VAT</sup>
<b>C</b>	COV-SX15A Code : H10355	Protective bag for SX15A	79€ <sup>incl. VAT</sup>
<b>E</b>	iLINEcov Code : H10768	Protective bag for iLINE series subwoofers	69,00€ <sup>incl. VAT</sup>
<b>G</b>	COV-ATOM12A Code : H10785	Protective bag for ATOM12A	69€ <sup>incl. VAT</sup>
<b>I</b>	COV-ATOM15ASUB Code : H10787	Protective bag for ATOM15ASUB	89€ <sup>incl. VAT</sup>
<b>K</b>	COV-SR15 Code : H10169	Bag for SR15A speaker	79€ <sup>incl. VAT</sup>
<b>M</b>	COV-SR10 Code : H10167	Bag for SR10A speaker	65,00€ <sup>incl. VAT</sup>
<b>O</b>	COV-MOJ01000FX Code : H10350	Travel bag + trolley for MOJ01000FX	119,00€ <sup>incl. VAT</sup>
<b>Q</b>	COV-CR25A Code : H10791	Protective bag for CR25A-COMBO	109€ <sup>incl. VAT</sup>
<b>S</b>	COV-CR80A Code : H10431	Bag for CR80A-COMBO loudspeaker	69,00€ <sup>incl. VAT</sup>
<b>U</b>	COV-CROSS Code : H9985	Carrying bag for CROSSER loudspeakers	39,00€ <sup>incl. VAT</sup>
<b>W</b>	TOURING BAG Code : B00597	Carrying bag for PS-15/PSA-15	49,00€ <sup>incl. VAT</sup>
<b>Y</b>	TOURING BAG - Vibe 15 Code : B00592	Carrying bag for Vibe 15	54,90€ <sup>incl. VAT</sup>
<b>A1</b>	TOURING BAG - Vibe 18 SUB Code : B00595	Carrying Bag for Vibe 18 SUB!!!!	79,00€ <sup>incl. VAT</sup>
<b>C1</b>	COV-SRSUB18A Code : H10887	Bag for COV-SRSUB18A subwoofer	119€ <sup>incl. VAT</sup>

<b>B</b>	COV-SX12A Code : H10854	Protective bag for SX12A	69€ <sup>incl. VAT</sup>
<b>D</b>	iLINEbag Code : H10767	Carrying bag for 2 iLINE 8 HP columns or 2 iLINEspace 60	59,00€ <sup>incl. VAT</sup>
<b>F</b>	COV-ATOM10A Code : H10784	Protective bag for ATOM10A	65€ <sup>incl. VAT</sup>
<b>H</b>	COV-ATOM15A Code : H10786	Protective bag for ATOM15A	79€ <sup>incl. VAT</sup>
<b>J</b>	COV-ATOM18ASUB Code : H10788	Protective bag for ATOM18ASUB	119€ <sup>incl. VAT</sup>
<b>L</b>	COV-SR12 Code : H10168	Bag for SR12A speaker	69,00€ <sup>incl. VAT</sup>
<b>N</b>	COV-SRSUB15A Code : H10351	Protective bag for SRSUB15A subwoofer	89,00€ <sup>incl. VAT</sup>
<b>P</b>	COV-BOOMBOX Code : H10488	Carrying bag for BOOMBOX	49,00€ <sup>incl. VAT</sup>
<b>R</b>	COV-CR12A Code : H10208	Bag for CR12A-COMBO loudspeaker	99,00€ <sup>incl. VAT</sup>
<b>T</b>	COV-SPRINT Code : H9986	Carrying bag for SPRINTER loudspeakers	35,00€ <sup>incl. VAT</sup>
<b>V</b>	TOURING BAG - PS-12/PSA-12 Code : B00596	Protective cover for PS-12, PSA-12, PPA-121	39,90€ <sup>incl. VAT</sup>
<b>X</b>	TOURING BAG - Vibe 12 Code : B00591	Carrying bag for Vibe 12	39,00€ <sup>incl. VAT</sup>
<b>Z</b>	TOURING BAG - Vibe 15 SUB !!!! Code : B00594	Carrying bag for Vibe 15 SUB!!!!	49,90€ <sup>incl. VAT</sup>
<b>B1</b>	TOURING BAG - Vibe 30 Code : B00593	Carrying bag for Vibe 30	82,50€ <sup>incl. VAT</sup>



# BATTERIES



<b>A</b>	PILE-LR03	Blister alkaline battery 4 x 1.5 V	Code : H8147	3.60€ <sup>Incl. VAT</sup>
<b>B</b>	PILE-LR06	Blister alkaline battery 4 x 1.5 V	Code : H8148	3.40€ <sup>Incl. VAT</sup>
<b>C</b>	PILE-6LR61	Blister alkaline battery 1 x 9 V	Code : H8146	3.60€ <sup>Incl. VAT</sup>
<b>D</b>	PILE-VI-6LR61	VARTA INDUSTRIAL 9V battery (in blister of 20)	Code : H10743	60€ <sup>Incl. VAT</sup>
<b>E</b>	PILE-VI-LR6	VARTA INDUSTRIAL 1.5V LR6 battery (in blister of 10)	Code : H10744	7.70€ <sup>Incl. VAT</sup>
<b>F</b>	PILE-VI-LR3	VARTA INDUSTRIAL 1.5V LR3 battery (in blister of 10)	Code : H10745	7.20€ <sup>Incl. VAT</sup>
<b>G</b>	PILE-VCR2025	VARTA CR2025 button battery (in blister of 10)	Code : H10746	18.10€ <sup>Incl. VAT</sup>



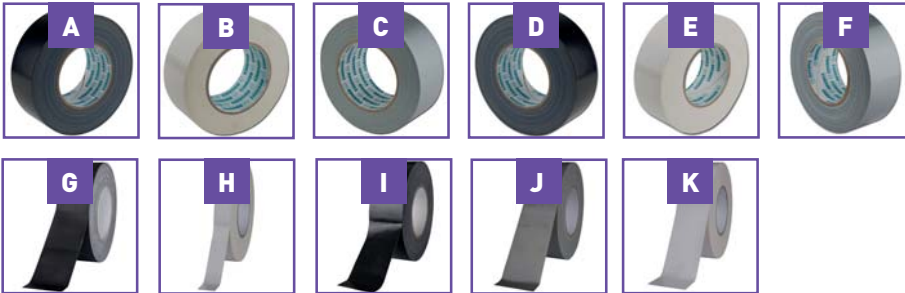





# GAFFAS



<b>A</b>	GAFFA-STD/NO	Gaffa 50mm x 50m standard black	Code : H3955	8.90€ <sup>Incl. VAT</sup>
<b>B</b>	GAFFA-STD/WH	Roll of 50m x 5cm - White	Code : H8872	8.90€ <sup>Incl. VAT</sup>
<b>C</b>	GAFFA-STD/GR	Roll of 50m x 5cm - Grey	Code : H8873	8.90€ <sup>Incl. VAT</sup>
<b>D</b>	GAFFA-PRO/NO	Gaffa 50mm x 50m professional black	Code : H3956	17.90€ <sup>Incl. VAT</sup>
<b>E</b>	GAFFA-PRO/WH	Roll of 50 m x 5 cm canvas - White	Code : H8874	18.50€ <sup>Incl. VAT</sup>
<b>F</b>	GAFFA-PRO/GR	Roll of 50m x 5cm canvas - Grey	Code : H8875	18.50€ <sup>Incl. VAT</sup>
<b>G</b>	GAFFER TAPE MATT 50 BLACK	High quality matt black canvas tape of 50m x 5 cm.	Code : B06104	13.90€ <sup>Incl. VAT</sup>
<b>H</b>	GAFFER TAPE STD 25 WHITE	High quality white tape 50m x 25mm.	Code : B06103	5.90€ <sup>Incl. VAT</sup>
<b>I</b>	GAFFER TAPE STD 50 BLACK	High quality black canvas tape 50m x 5 cm.	Code : B06100	9.90€ <sup>Incl. VAT</sup>
<b>J</b>	GAFFER TAPE STD 50 GREY	High-quality grey canvas tape 50m x 5 cm.	Code : B06101	9.90€ <sup>Incl. VAT</sup>
<b>K</b>	GAFFER TAPE STD 50 WHITE	High-quality white canvas tape 50m x 5 cm.	Code : B06102	9.90€ <sup>Incl. VAT</sup>

# COLOURING



<b>A</b>	COLOR FILTER Sheet «Congo Blue 181”	1.22 x 0.53m "Congo Blue 181" colour sheet	Code : B04564	11.90€ <sup>Incl. VAT</sup>	
<b>B</b>	COLOR FILTER Sheet «Dark Green 124”	1.22 x 0.53m "Dark Green 124" colour sheet	Code : B04566	11.90€ <sup>Incl. VAT</sup>	
<b>C</b>	COLOR FILTER Sheet «Magenta 113”	1.22 x 0.53m "Magenta 113" colour sheet	Code : B04567	11.90€ <sup>Incl. VAT</sup>	
<b>D</b>	COLOR FILTER Sheet «Mauve 126”	1.22 x 0.53m "Mauve 126" colour sheet	Code : B04569	11.90€ <sup>Incl. VAT</sup>	
<b>E</b>	COLOR FILTER Sheet «Medium Blue-Green”	1.22 x 0.53m "Medium Blue-Green" colour sheet	Code : B04568	11.90€ <sup>Incl. VAT</sup>	
<b>F</b>	COLOR FILTER Sheet «Orange 105”	1.22 x 0.53m "Orange 105" colour sheet	Code : B04561	11.90€ <sup>Incl. VAT</sup>	
<b>G</b>	COLOR FILTER Sheet «Primary Green 139”	1.22 x 0.53m "Primary Green 139" colour sheet	Code : B04565	11.90€ <sup>Incl. VAT</sup>	
<b>H</b>	COLOR FILTER Sheet «Primary Red 106”	1.22 x 0.53m "Primary Red 106" colour sheet	Code : B04562	11.90€ <sup>Incl. VAT</sup>	
<b>I</b>	COLOR FILTER Sheet «Sky Blue 068”	1.22 x 0.53m "Sky Blue 068" colour sheet	Code : B04563	11.90€ <sup>Incl. VAT</sup>	
<b>J</b>	COLOR FILTER Sheet «Vanity Fair 793”	1.22 x 0.53m "Vanity Fair 793" colour sheet	Code : B04570	11.90€ <sup>Incl. VAT</sup>	
<b>K</b>	COLOR FILTER Sheet «Yellow 101”	1.22 x 0.53m "Yellow 101" colour sheet	Code : B04560	12.90€ <sup>Incl. VAT</sup>	
<b>L</b>	FILTER SHEETS PAR56 PRO- 10 col.	Set of filters, 10 different colours	Code : B04553	12.90€ <sup>Incl. VAT</sup>	
<b>M</b>	FILTER SHEETS PAR56 PRO- 5 col.	Set of filters, 5 different colours	Code : B04552	7.29€ <sup>Incl. VAT</sup>	
<b>N</b>	FILTER SHEETS PAR56 SH - 10 col.	Set of filters, 10 different colours	Code : B04551	9.90€ <sup>Incl. VAT</sup>	
<b>O</b>	FILTER SHEETS PAR56 SH - 5 col.	Set of filters, 5 different colours	Code : B04550	5.90€ <sup>Incl. VAT</sup>	
<b>P</b>	FILTER SHEETS PAR64 PRO- 10 col.	Set of filters, 10 different colours	Code : B04555	17.90€ <sup>Incl. VAT</sup>	
<b>Q</b>	FILTER SHEETS PAR64 PRO- 5 col.	Set of filters, 5 different colours	Code : B04554	10.29€ <sup>Incl. VAT</sup>	



# GOOSENECK LIGHTS



**Hilec**  
LIGHT & SOUND ACCESSORIES

<b>A</b>	Snake16USB	Flexible lamp with 6 white COB LEDs - USB	Code : H10802	9,90€ <sup>Incl. VAT</sup>
<b>B</b>	Snake16	1-arm desk lamp with 6 white COB LEDs	Code : H10803	16€ <sup>Incl. VAT</sup>
<b>C</b>	Snake23DUO	2-arm desk lamp with 3 white COB LEDs	Code : H10804	9,90€ <sup>Incl. VAT</sup>
<b>D</b>	Snake118DeskW	Desk lamp with 18 warm white COB LEDs	Code : H10805	32€ <sup>Incl. VAT</sup>
<b>E</b>	Snake118DeskC	Desk lamp with 18 cool white COB LEDs	Code : H10806	32€ <sup>Incl. VAT</sup>
<b>F</b>	Snake16M	Flexible LED lamp + magnetic baseplate + Battery	Code : H10807	25€ <sup>Incl. VAT</sup>
<b>G</b>	Snake26Rack	2-arm USB rack light with white LEDs	Code : H10808	59€ <sup>Incl. VAT</sup>
<b>H</b>	Snake16RGBUSB	Flexible lamp with 6 RGB COB LEDs - USB	Code : H10809	13,50€ <sup>Incl. VAT</sup>
<b>I</b>	COB LED CLIP LIGHT WW	Very powerful 30cm flexible gooseneck lamp with clip	Code : B00226	35,90€ <sup>Incl. VAT</sup>
<b>J</b>	COB LED MINILIGHT WW	Very powerful 30cm flexible gooseneck lamp	Code : B00224	49,90€ <sup>Incl. VAT</sup>
<b>K</b>	COB LED RACKLIGHT WW	Very powerful 30cm flexible gooseneck lamp for rack	Code : B00227	43,90€ <sup>Incl. VAT</sup>



# LINE AUDIO CABLES



<b>A</b>	CFLAT-XXMF/0.5 Code : H10810	XLR male / XLR female flat cable - 0.5m	15,10€ <sup>incl. VAT</sup>	<b>K</b>	CL-41/1.5 Code : H10674	2 x XLR male / 2 x stereo male jack cable - 1.5m	10,10€ <sup>incl. VAT</sup>
	CFLAT-XXMF/1 Code : H10811	XLR female / XLR male flat cable - 1m	15,80€ <sup>incl. VAT</sup>		CL-41/3 Code : H10675	2 x XLR male / 2 x stereo male jack cable - 3m	11,60€ <sup>incl. VAT</sup>
	CFLAT-XXMF/1.5 Code : H10812	XLR female / XLR male flat cord - 1.5m	16,60€ <sup>incl. VAT</sup>	<b>L</b>	CL-42/1.5 Code : H10676	2 x XLR female / 2 x mono male jack cable - 1.5m	9,80€ <sup>incl. VAT</sup>
<b>B</b>	CFLAT-JSJS/0.5 Code : H10813	TRS jack / TRS jack flat cable - 0.5m	13,70€ <sup>incl. VAT</sup>		CL-42/3 Code : H10677	2 x XLR female / 2 x mono male jack cable - 3m	11,30€ <sup>incl. VAT</sup>
	CFLAT-JSJS/1 Code : H10814	TRS jack / TRS jack flat cable - 1m	14,50€ <sup>incl. VAT</sup>	<b>M</b>	CL-43/1.5 Code : H10678	2 x XLR female / 2 x stereo male jack cable - 1.5m	10,10€ <sup>incl. VAT</sup>
	CFLAT-JSJS/1.5 Code : H10815	Jack TRS / Jack TRS flat cord - 1.5m	15,20€ <sup>incl. VAT</sup>		CL-43/3 Code : H10679	2 x XLR female / 2 x stereo male jack cable - 3m	11,60€ <sup>incl. VAT</sup>
<b>C</b>	CFLAT-JSXF/0.5 Code : H10816	TRS Male / XLR Female 6.35 jack flat cable - 0.5m	12,60€ <sup>incl. VAT</sup>	<b>N</b>	CL-2XM2XF/0.6 Code : H10680	2 x XLR Male / 2 x XLR Female cable - 0.6m	8,30€ <sup>incl. VAT</sup>
	CFLAT-JSXF/1 Code : H10817	TRS Male / XLR Female 6.35 jack flat cable - 1m	13,20€ <sup>incl. VAT</sup>		CL-2XM2XF/1.5 Code : H10681	2 x XLR female / 2 x XLR Male cable - 1.5m	9,20€ <sup>incl. VAT</sup>
	CFLAT-JSXF/1.5 Code : H10818	XLR Female / Jack 6.35 TRS Male flat cord - 1.5m	13,80€ <sup>incl. VAT</sup>		CL-2XM2XF/3 Code : H10682	2 x XLR Male / 2 x XLR female cable - 3m	10,70€ <sup>incl. VAT</sup>
<b>D</b>	CFLAT-JSXM/0.5 Code : H10819	TRS Male / XLR Male 6.35 jack flat cable - 0.5m	11,40€ <sup>incl. VAT</sup>		CL-2XM2XF/6 Code : H10683	2 x XLR Male / 2 x XLR female cable - 6m	13,60€ <sup>incl. VAT</sup>
	CFLAT-JSXM/1 Code : H10820	TRS Male / XLR Male 6.35 jack flat cable - 1m	12€ <sup>incl. VAT</sup>	<b>O</b>	ADAPT2010 Code : H10697	Female / 2 x RCA male 3.5 jack cable	10€ <sup>incl. VAT</sup>
	CFLAT-JSXM/1.5 Code : H10821	XLR Male / Jack 6.35 TRS Male flat cord - 1.5m	12,60€ <sup>incl. VAT</sup>	<b>P</b>	ADAPT2020 Code : H10698	1 stereo male 3.5 jack / 2 stereo female 3.5 jack cable - Black	6€ <sup>incl. VAT</sup>
<b>E</b>	CFLAT-RCA/0.5 Code : H10822	RCA male / RCA male flat cable - 0.5m	11,70€ <sup>incl. VAT</sup>	<b>Q</b>	CL-05/1.5 Code : H7976	Male 6mm jack / Mono male jack line cable - 1.5m	2,90€ <sup>incl. VAT</sup>
	CFLAT-RCA/1 Code : H10823	RCA male / RCA male flat cable - 1m	12,50€ <sup>incl. VAT</sup>		CL-05/3 Code : H7977	Male 6mm jack / Mono male jack line cable - 3m	3,90€ <sup>incl. VAT</sup>
	CFLAT-RCA/1.5 Code : H10824	RCA male / RCA male flat cord - 1.5m	13,20€ <sup>incl. VAT</sup>		CL-05/6 Code : H7978	Male 6mm jack / Mono male jack line cable - 6m	6,10€ <sup>incl. VAT</sup>
<b>F</b>	CFLAT-JMJM/0.5 Code : H10825	6.35 J mono / 6.35 J mono flat cable - 0.5	10,30€ <sup>incl. VAT</sup>		CL-05/10 Code : H7979	Male 6mm jack / Mono male jack line cable - 10m	8,90€ <sup>incl. VAT</sup>
	CFLAT-JMJM/1 Code : H10826	Mono 6.35 jack / mono 6.35 jack flat cable - 1	10,90€ <sup>incl. VAT</sup>	<b>R</b>	CL/JMJM-1,5 Code : H7980	Male jack / Mono male jack line cable - 1.5m	4,60€ <sup>incl. VAT</sup>
	CFLAT-JMJM/1.5 Code : H10827	J 6.35 Mono / J 6.35 mono flat cord - 1.5	11,50€ <sup>incl. VAT</sup>		CL/JMJM-3 Code : H7981	Male jack / Mono male jack line cable - 3m	5,90€ <sup>incl. VAT</sup>
<b>G</b>	CL-32/1.5 Code : H10668	Stereo / 2 x XLR male 3.5 jack cable - 1.5m	6,30€ <sup>incl. VAT</sup>		CL/JMJM-6 Code : H7982	Male jack / Mono male jack line cable - 6m	8,60€ <sup>incl. VAT</sup>
	CL-32/3 Code : H10669	Stereo / 2 x XLR male 3.5 jack cable - 3m	8,20€ <sup>incl. VAT</sup>		CL/JMJM-10 Code : H7983	Male jack / Mono male jack line cable - 10m	12,40€ <sup>incl. VAT</sup>
<b>H</b>	CL-28/0.6 Code : H10670	1 XLR female / 2 x XLR male cable - 0.6m	6,70€ <sup>incl. VAT</sup>		CL/JMJM-20 Code : H7984	Male jack / Mono male jack line cable - 20m	21,30€ <sup>incl. VAT</sup>
<b>I</b>	CL-29/0.6 Code : H10671	1 XLR male / 2 x XLR female cable - 0.6m	6,70€ <sup>incl. VAT</sup>				
<b>J</b>	CL-40/1.5 Code : H10672	2 x mono 6.35 jack / 2 x XLR male cable - 1.5m	9,80€ <sup>incl. VAT</sup>				
	CL-40/3 Code : H10673	2 x mono 6.35 jack / 2 x XLR male cable - 3m	11,30€ <sup>incl. VAT</sup>				



# LINE AUDIO CABLES



<b>A</b>	CL-07/1.5 Code : H7995	Stereo Male jack / stereo Male jack line cable - 1.50m	3.50€ <sup>Incl. VAT</sup>
	CL-07/3 Code : H7996	Stereo Male jack / stereo Male jack line cable - 3m	4.60€ <sup>Incl. VAT</sup>
	CL-07/6 Code : H7997	Stereo Male jack / stereo Male jack line cable - 6m	7.30€ <sup>Incl. VAT</sup>
	CL-07/10 Code : H7998	Stereo Male jack / stereo Male jack line cable - 10m	11.20€ <sup>Incl. VAT</sup>
<b>B</b>	CL-71/1.5 Code : H7999	Stereo Male 3.5 mm jack / stereo Male 6.35 jack line cable - 1.50m	2.90€ <sup>Incl. VAT</sup>
	CL-71/3 Code : H8000	Stereo Male 3.5 mm jack / stereo Male 6.35 jack line cable - 3m	4€ <sup>Incl. VAT</sup>
	CL-71/6 Code : H8001	Stereo Male 3.5 mm jack / stereo Male 6.35 jack line cable - 6m	5.70€ <sup>Incl. VAT</sup>
	CL-71/10 Code : H8002	Stereo Male 3.5 mm jack / stereo Male 6.35 jack line cable - 10m	8.10€ <sup>Incl. VAT</sup>
<b>C</b>	CL-72/1.5 Code : H8003	Jack 3,5 mm stereo Male / Jack 3,5 stereo Male cord line - 1.50m	3.10€ <sup>Incl. VAT</sup>
	CL-72/3 Code : H8004	Jack 3,5 mm Stereo Male / Jack 3,5 stereo Male cord line - 3m	4€ <sup>Incl. VAT</sup>
	CL-72/6 Code : H8005	Jack 3,5 mm Stereo Male / Jack 3,5 stereo Male cord line - 6m	5.70€ <sup>Incl. VAT</sup>
	CL-72/10 Code : H8006	Jack 3,5 mm stereo Male / Jack 3,5 stereo Male cord line - 10m	8.10€ <sup>Incl. VAT</sup>
<b>D</b>	CL-23/1.5 Code : H8007	2x4mm 2x Male jack / 2xRCA Male line cable - 1.5m	5€ <sup>Incl. VAT</sup>
	CL-23/3 Code : H8008	2x4mm 2x Male jack / 2xRCA Male line cable - 3m	6.30€ <sup>Incl. VAT</sup>
<b>E</b>	CL-35/1.5 Code : H8009	2x4mm 1 stereo Male jack / 2xRCA Male line cable - 1.5m	4.30€ <sup>Incl. VAT</sup>
	CL-35/3 Code : H8010	2x4mm 1 stereo Male jack / 2xRCA Male line cable - 3m	5.70€ <sup>Incl. VAT</sup>
	CL-35/6 Code : H8011	2x4mm 1 stereo Male jack / 2xRCA Male line cable - 6m	8.50€ <sup>Incl. VAT</sup>
<b>F</b>	CL-36/1.5 Code : H9294	Stereo male 6.35 jack / 2 x mono 6.35 jack line cable - 1.5m	4.80€ <sup>Incl. VAT</sup>
	CL-36/3 Code : H9295	Stereo male 6.35 jack / 2 x mono 6.35 jack line cable - 3m	6.50€ <sup>Incl. VAT</sup>
<b>G</b>	CL-25/1.5 Code : H8165	2x4mm 2xXLR Female / 2xRCA Male line cable - 1.5m	6.70€ <sup>Incl. VAT</sup>
	CL-25/3 Code : H8166	2x4mm 2xXLR Female / 2xRCA Male line cable - 3m	8€ <sup>Incl. VAT</sup>

<b>H</b>	CL-26/1.5 Code : H8167	2x4mm 2xXLR Male / 2xRCA Male line cable - 1.5m	6.60€ <sup>Incl. VAT</sup>
	CL-26/3 Code : H8168	2x4mm 2xXLR Male / 2xRCA Male line cable - 3m	8.10€ <sup>Incl. VAT</sup>
<b>I</b>	FL-22/1.5 Code : H8012	2x4mm 2x Male jack / 2x Mono male jack line cable - 1.5m	5.10€ <sup>Incl. VAT</sup>
	FL-22/3 Code : H8013	2x4mm 2x Male jack / 2x Mono male jack line cable - 3m	6.50€ <sup>Incl. VAT</sup>
	FL-22/6 Code : H8014	2x4mm 2x Male jack / 2x Mono Male jack line cable - 6m	9.30€ <sup>Incl. VAT</sup>
<b>J</b>	CL-31/1.5 Code : H8015	2x4mm 1x stereo Male 3.5 jack / 2x Male jack line cable - 1.5m	4.10€ <sup>Incl. VAT</sup>
	CL-31/3 Code : H8016	2x4mm 1x stereo Male 3.5 jack / 2x Male jack line cable - 3m	5.50€ <sup>Incl. VAT</sup>
<b>K</b>	CL-30/1.5 Code : H8017	2x4mm 1x stereo Male 3.5 jack / 2xRCA Male line cable 1.5m	3.90€ <sup>Incl. VAT</sup>
	CL-30/3 Code : H8018	2x4mm 1x stereo Male 3.5 jack / 2xRCA Male line cable 3m	5.20€ <sup>Incl. VAT</sup>
<b>L</b>	CL-51/0.6 Code : H9299	DIN 5-pin male / DIN 5-pin male midi cable - 0.6m	2.60€ <sup>Incl. VAT</sup>
	CL-51/1 Code : H9300	DIN 5-pin male / DIN 5-pin male midi cable - 1m	6.40€ <sup>Incl. VAT</sup>
	CL-51/3 Code : H8019	DIN 5-pin male / DIN 5-pin male midi cable - 3m	6€ <sup>Incl. VAT</sup>
	CL-51/6 Code : H8020	DIN 5-pin male / DIN 5-pin male midi cable - 6m	9.40€ <sup>Incl. VAT</sup>
<b>M</b>	RCA1/C Code : H0049	2 RCA male / 2 RCA male cable - 1.2 m	2.60€ <sup>Incl. VAT</sup>
<b>N</b>	CL-24/1.5 Code : H7964	2x4mm 2xRCA Male / 2xRCA Male line cable - 1.5m	5.10€ <sup>Incl. VAT</sup>
	CL-24/3 Code : H7965	2x4mm 2xRCA Male / 2xRCA Male line cable - 3m	6.60€ <sup>Incl. VAT</sup>
	CL-24/6 Code : H7966	2x4mm 2xRCA Male / 2xRCA Male line cable - 6m	9.50€ <sup>Incl. VAT</sup>
<b>O</b>	CL-27/1.5 Code : H7967	2xRCA Female / 2xRCA Male line cable - 1.5m	5€ <sup>Incl. VAT</sup>
	CL-27/3 Code : H7968	2xRCA Female / 2xRCA Male line cable - 3m	6.30€ <sup>Incl. VAT</sup>
	CL-27/6 Code : H7969	2xRCA Female / 2xRCA Male line cable - 6m	10.70€ <sup>Incl. VAT</sup>



<b>A</b>	RCA11/C Code : H7970	High quality cable - 2 RCA male / 2 RCA male - 1.20m	7.70€ <sup>Incl. VAT</sup>
	RCA13/C Code : H7971	High quality cable - 2 RCA male / 2 RCA male - 3m	10.20€ <sup>Incl. VAT</sup>
	RCA15/C Code : H7972	High quality cable - 2 RCA male / 2 RCA male - 5m	12.90€ <sup>Incl. VAT</sup>
<b>B</b>	RCA/PH Code : H7973	2 RCA male / 2 RCA male cable + mass - 3m	11.40€ <sup>Incl. VAT</sup>
<b>C</b>	RCA25/C Code : H7974	4 RCA male / 4 RCA male cable - 1.50m	9.30€ <sup>Incl. VAT</sup>
<b>D</b>	2-0365 Code : B01220	Signal cable, 2xRCA + 2xRCA 0.5m	3.90€ <sup>Incl. VAT</sup>
	2-0368 Code : B01221	Signal cable, 2xRCA+2xRCA 1.0m	4.50€ <sup>Incl. VAT</sup>
	2-0370 Code : B01222	Signal cable, 2xRCA + 2xRCA 1.5m	4.90€ <sup>Incl. VAT</sup>
	2-0375 Code : B01223	Signal cable, 2xRCA + 2xRCA 2,5m	4.49€ <sup>Incl. VAT</sup>
	2-0380 Code : B01224	Signal cable, 2xRCA+2xRCA 5,0m	7.50€ <sup>Incl. VAT</sup>
<b>E</b>	2-0425 Code : B01210	Signal cable, mono jack + mono jack 6m	9.90€ <sup>Incl. VAT</sup>
	2-0426 Code : B01211	Signal cable, mono jack + mono jack 10m	11.90€ <sup>Incl. VAT</sup>
<b>F</b>	2-0430 Code : B01215	Signal cable, 2xRCA+ mono jack 1.5m	4.50€ <sup>Incl. VAT</sup>
	2-0435 Code : B01216	Signal cable, 2xRCA+ mono jack 3m	6.40€ <sup>Incl. VAT</sup>
<b>G</b>	2-0440 Code : B01235	Signal cable, 2xRCA+XLRf 1.5m	6.90€ <sup>Incl. VAT</sup>
<b>H</b>	2-0445 Code : B01230	Signal cable, 2xRCA+XLRm 1.5m	6.90€ <sup>Incl. VAT</sup>

<b>I</b>	INSERT-JACKm-1M5 Code : B01240	Insert cable - stereo jack - 2x mono jack - 1.5m	4.50€ <sup>Incl. VAT</sup>
	INSERT-JACKm-3M Code : B01241	Insert cable - stereo jack - 2x mono jack - 3m	4.90€ <sup>Incl. VAT</sup>
<b>J</b>	JACKm/JACKm-90D-0M <sup>3</sup> Code : B01242	Multicolour Jack ←→ Jack 90° - 0.3m (6pcs)	8.90€ <sup>Incl. VAT</sup>
<b>K</b>	JACKm/JACKm-TWIN-1M5 Code : B01243	2x mono jack - 2x mono jack cable - 1.5m	4.90€ <sup>Incl. VAT</sup>
	JACKm/JACKm-TWIN-3M Code : B01244	2x mono jack - 2x mono jack cable - 3m	5.90€ <sup>Incl. VAT</sup>
<b>L</b>	miniJACK/2xJACK-1M5 Code : B01245	Stereo 3.5 jack - 2x mono jack cable - 1.5m	4.19€ <sup>Incl. VAT</sup>
	miniJACK/2xJACK-3M Code : B01246	Stereo 3.5 jack - 2x mono jack cable - 3m	4.90€ <sup>Incl. VAT</sup>
<b>M</b>	MJC-1M5 Code : B01217	Signal cable, 2xRCA+ stereo 3.5 jack 1.5m	3.90€ <sup>Incl. VAT</sup>
<b>N</b>	MJMJ-1M5 Code : B01236	Male 3.5 jack / male 3.5 jack cable - 1.5m	4.90€ <sup>Incl. VAT</sup>
<b>O</b>	MJMJf-3M Code : B01237	3.5 jack/3.5 jack extension - 3m	4.90€ <sup>Incl. VAT</sup>
<b>P</b>	RCAm/RCAf-TWIN-3M Code : B01247	2x RCA male ←→ 2x RCA female cable - 3m	5.50€ <sup>Incl. VAT</sup>
<b>Q</b>	SJXF-1M5 Code : B01218	Balanced signal cable, Stereo Jack / XLR Female 1.5m	5.39€ <sup>Incl. VAT</sup>
<b>R</b>	SJXM-1M5 Code : B01219	Balanced signal cable, Stereo Jack/ XLR Male 1.5m	4.90€ <sup>Incl. VAT</sup>
<b>S</b>	SNAKE-8XLRmf-3M Code : B01248	Snake cable 8x XLRm ←→ XLRf - 3m	29.90€ <sup>Incl. VAT</sup>
	SNAKE-8XLRmf-6M Code : B01249	Snake cable 8x XLRm ←→ XLRf - 6m	32.90€ <sup>Incl. VAT</sup>
	SNAKE-8XLRmf-9M Code : B01250	Snake cable 8x XLRm ←→ XLRf - 9m	44.90€ <sup>Incl. VAT</sup>



# MICROPHONE CABLES



<b>A</b>	CM/XFXM-0,6 Code : H9298	XLR female / XLR male microphone cable - 0.6m	3.70€ <sup>Incl. VAT</sup>	<b>C</b>	CM/XMJM-1,5 Code : H9296	XLR male / mono male 6.35 jack microphone cable - 1.5m	4.30€ <sup>Incl. VAT</sup>
	CM/XFXM-1,5 Code : H7947	XLR female / XLR male microphone cable - 1.5m	4.20€ <sup>Incl. VAT</sup>		CM/XMJM-3 Code : H9297	XLR male / mono male 6.35 jack microphone cable - 3m	5.40€ <sup>Incl. VAT</sup>
	CM/XFXM-3 Code : H7948	XLR female / XLR male microphone cable - 3m	5.50€ <sup>Incl. VAT</sup>		CM/XMJM-6 Code : H7957	XLR male / mono male 6.35 jack microphone cable - 6m	6.90€ <sup>Incl. VAT</sup>
	CM/XFXM-6 Code : H7949	XLR female / XLR male microphone cable - 6m	8.10€ <sup>Incl. VAT</sup>		CM/XMJM-10 Code : H7958	XLR male / mono male 6.35 jack microphone cable - 10m	10.20€ <sup>Incl. VAT</sup>
	CM/XFXM-10 Code : H7950	XLR female / XLR male microphone cable - 10m	11.50€ <sup>Incl. VAT</sup>	<b>D</b>	7-0060 Code : B01205	Signal cable, XLR+mono jack 5m	7.90€ <sup>Incl. VAT</sup>
	CM/XFXM-20 Code : H7951	XLR female / XLR male microphone cable - 20m	19.90€ <sup>Incl. VAT</sup>		7-0066 Code : B01206	Signal cable, XLR+mono jack 10m	10.99€ <sup>Incl. VAT</sup>
<b>A1</b>	XMF-0.50M Code : B01207	Signal cable, XLR+XLRm 0.5m	3.59€ <sup>TTC</sup>	<b>E</b>	7-0061 Code : B01203	Signal cable, XLR+XLRm 1m	3.90€ <sup>Incl. VAT</sup>
<b>B</b>	CM/XFJM-1,5 Code : H7952	XLR female / male jack microphone cable - 1.5m	4.50€ <sup>Incl. VAT</sup>		7-0062 Code : B01204	Signal cable, XLR+XLRm 2,5m	4.90€ <sup>Incl. VAT</sup>
	CM/XFJM-3 Code : H7953	XLR female / male jack microphone cable - 3m	5.40€ <sup>Incl. VAT</sup>		7-0063 Code : B01200	Signal cable, XLR+XLRm 5m	6.90€ <sup>Incl. VAT</sup>
	CM/XFJM-6 Code : H7954	XLR female / male jack microphone cable - 6m	7.70€ <sup>Incl. VAT</sup>		7-0067 Code : B01201	Signal cable, XLR+XLRm 10m	10.90€ <sup>Incl. VAT</sup>
	CM/XFJM-10 Code : H7955	XLR female / male jack microphone cable - 10m	10.40€ <sup>Incl. VAT</sup>		7-0068 Code : B01202	Signal cable, XLR+XLRm 20m	16.90€ <sup>Incl. VAT</sup>
	CM/XFJM-20 Code : H7956	XLR female / male jack microphone cable - 20m	17.60€ <sup>Incl. VAT</sup>				

# SPEAKER CABLES



<b>A</b>	CH/JMJM-1.5 Code : H8023	Male jack / Male jack 2x1.5 HP cable - 1.5m	5.90€ <sup>Incl. VAT</sup>	<b>D</b>	CSP215/0.5 Code : H10695	2 speaker cable x 1.5 mm <sup>2</sup> speakon/speakon NEUTRIK - 0.5m	28.20€ <sup>Incl. VAT</sup>
	CH/JMJM-3 Code : H8024	Male jack / Male jack 2x1.5 HP cable - 3m	11.80€ <sup>Incl. VAT</sup>		CSP215/1 Code : H10696	2 speaker cable x 1.5 mm <sup>2</sup> speakon/speakon NEUTRIK - 1m	29€ <sup>Incl. VAT</sup>
	CH/JMJM-10 Code : H8025	Male jack / Male jack 2x1.5 HP cable - 10m	20.70€ <sup>Incl. VAT</sup>		CSP215/3 Code : H9840	2 speaker cable x 1.5 mm <sup>2</sup> speakon/speakon NEUTRIK - 3m	30€ <sup>Incl. VAT</sup>
	CH/JMJM-15 Code : H8026	Male jack / Male jack 2x1.5 HP cable - 15m	29.90€ <sup>Incl. VAT</sup>		CSP215/6 Code : H9841	2 speaker cable x 1.5 mm <sup>2</sup> speakon/speakon NEUTRIK - 6m	34€ <sup>Incl. VAT</sup>
<b>B</b>	CH/SMJM-3 Code : H8034	Speakon Male / Male jack 2x1.5 HP cable - 3m	11.20€ <sup>Incl. VAT</sup>		CSP215/10 Code : H9842	2 speaker cable x 1.5 mm <sup>2</sup> speakon/speakon NEUTRIK - 10m	38€ <sup>Incl. VAT</sup>
	CH/SMJM-6 Code : H8035	Speakon Male / Male jack 2x1.5 HP cable - 6m	16.50€ <sup>Incl. VAT</sup>	<b>E</b>	2-0505 Code : B01252	Speakon Male / speakon Male HP cable - 5m	17.90€ <sup>Incl. VAT</sup>
	CH/SMJM-10 Code : H8036	Speakon Male / Male jack 2x1.5 HP cable - 10m	23.50€ <sup>Incl. VAT</sup>		2-0510 Code : B01253	Speakon Male / speakon Male HP cable - 10m	29€ <sup>Incl. VAT</sup>
	CH/SMJM-20 Code : H8037	Speakon Male / Male jack 2x1.5 HP cable - 20m	41.10€ <sup>Incl. VAT</sup>		2-0525 Code : B01254	Speakon Male / speakon Male HP cable - 25m	59€ <sup>Incl. VAT</sup>
<b>C</b>	CS-21/3 Code : H8038	Speakon Male / speakon Male 2x1.5 HP cable - 3m	12.60€ <sup>Incl. VAT</sup>				
	CS-21/6 Code : H8039	Speakon Male / speakon Male 2x1.5 HP cable - 6m	17.80€ <sup>Incl. VAT</sup>				
	CS-21/10 Code : H8040	Speakon Male / speakon Male 2x1.5 HP cable - 10m	23.60€ <sup>Incl. VAT</sup>				
	CS-21/15 Code : H8041	Speakon Male / speakon Male 2x1.5 HP cable - 15m	34.10€ <sup>Incl. VAT</sup>				
	CS-21/20 Code : H8042	Speakon Male / speakon Male 2x1.5 HP cable - 20m	42.70€ <sup>Incl. VAT</sup>				

# DMX CABLES



<b>A</b>	CDU0-10 Code : H9274	VDE / CEE - XLR male / XLR female hybrid audio cable - 10 metres	71,50€ <sup>Incl. VAT</sup>
	CDU0-20 Code : H9293	VDE / CEE - XLR male / XLR female Hybrid Sound Cord - 20 meters	118,90€ <sup>Incl. VAT</sup>
<b>B</b>	AUDIO COMBI CABLE IEC/XLR-10M Code : B01401	IEC / XLR Male / XLR Female Hybrid Sound Cord - 10 Meters	59€ <sup>Incl. VAT</sup>
	AUDIO COMBI CABLE IEC/XLR-20M Code : B01402	IEC / XLR Male / XLR Female Hybrid Sound Cord - 20 Meters	109€ <sup>Incl. VAT</sup>

<b>C</b>	AUDIO COMBI CABLE IEC/XLR-5M Code : B01400	IEC / XLR Male / XLR Female hybrid audio cable - 5 metres	35,90€ <sup>Incl. VAT</sup>
	AUDIO COMBI CABLE SCHUKO/XLR-10M Code : B01404	VDE / CEE - XLR male / XLR female Hybrid Sound Cord - 10 meters	59€ <sup>Incl. VAT</sup>
<b>C</b>	AUDIO COMBI CABLE SCHUKO/XLR-20M Code : B01405	VDE / CEE - XLR male / XLR female Hybrid Sound Cord - 20 meters	109€ <sup>Incl. VAT</sup>
	AUDIO COMBI CABLE SCHUKO/XLR-5M Code : B01403	VDE / CEE - XLR male / XLR female Hybrid Sound Cord - 5 metres	35,90€ <sup>Incl. VAT</sup>

# DMX CABLES



<b>A</b>	CDMX-0.6 Code : H10699	DMX XLR male / XLR female 3 pin cable - 0.6m	4,70€ <sup>Incl. VAT</sup>
	CDMX-1 Code : H9273	Cable for DMX XLR Male / XLR female 3 pins Length: 1 m	4,90€ <sup>Incl. VAT</sup>
	CDMX-1.5 Code : H9288	Cord for DMX XLR Male / XLR female 3 pins Length: 1.5 m	5,80€ <sup>Incl. VAT</sup>
	CDMX-3 Code : H9289	Cord for DMX XLR Male / XLR female 3 pins Length: 3 m	8,50€ <sup>Incl. VAT</sup>
	CDMX-5 Code : H9290	Cord for DMX XLR Male / XLR female 3 pins Length: 5 m	12,10€ <sup>Incl. VAT</sup>
	CDMX-10 Code : H9291	Cord for DMX XLR Male / XLR female 3 pins Length: 10 m	21,40€ <sup>Incl. VAT</sup>
	CDMX-20 Code : H9292	Cord for DMX XLR Male / XLR female 3 pins Length: 20 m	40€ <sup>Incl. VAT</sup>

<b>B</b>	XLR5 M-M 0,5M Code : B01208	DMX conversion cable: 5-pin male to male XLR connectors	6,90€ <sup>Incl. VAT</sup>
<b>C</b>	IPCD-1 Code : H10722	DMX 3P waterproof connection cable for IPZOOM - 1m	15€ <sup>Incl. VAT</sup>
	IPCD-2 Code : H10723	DMX 3P waterproof connection cable for IPZOOM - 2m	17€ <sup>Incl. VAT</sup>
	IPCD-5 Code : H10724	DMX 3P waterproof connection cable for IPZOOM - 5m	25€ <sup>Incl. VAT</sup>

 **Hilec**  
LIGHT & SOUND ACCESSORIES



# DMX COMBI CABLES



<b>A</b>	CPCDMXLINK-1 Code : H10686	POWERCON / XLR hybrid cable 3G1.5mm <sup>2</sup> - 1m	53.60€ <sup>incl. VAT</sup>
	CPCDMXLINK-3 Code : H10687	POWERCON / XLR hybrid cable 3G1.5mm <sup>2</sup> - 3m	66.30€ <sup>incl. VAT</sup>
	CPCDMXLINK-5 Code : H10688	POWERCON / XLR hybrid cable 3G1.5mm <sup>2</sup> - 5m	79.10€ <sup>incl. VAT</sup>
<b>B</b>	CPCDMXIN-3 Code : H10689	POWERCON-PC16A / XLR hybrid cable 3G1.5mm <sup>2</sup> - 3m	70.10€ <sup>incl. VAT</sup>
	CPCDMXIN-5 Code : H10690	POWERCON-PC16A / XLR hybrid cable 3G1.5mm <sup>2</sup> - 5m	82.90€ <sup>incl. VAT</sup>
	CPCDMXIN-10 Code : H10691	POWERCON-PC16A / XLR hybrid cable 3G1.5mm <sup>2</sup> - 10m	114.80€ <sup>incl. VAT</sup>
<b>C</b>	COMBI CABLE IEC/ XLR 1.3m Code : B01255	Power(IEC)+DMX cable 1.3m	11.50€ <sup>incl. VAT</sup>
	COMBI CABLE IEC/XLR 3M Code : B01256	Power(IEC)+DMX cable 3.0m	19€ <sup>incl. VAT</sup>
	COMBI CABLE IEC/XLR 5M Code : B01257	Power(IEC)+DMX cable 5,0m	26.90€ <sup>incl. VAT</sup>
	COMBI CABLE IEC/XLR 10M Code : B01258	Power(IEC)+DMX cable 10,0m	44.90€ <sup>incl. VAT</sup>

<b>D</b>	IP-POWER/XLR COMBI CABLE 1M3* Code : B01361	Length: 1.3 m.	31.90€ <sup>incl. VAT</sup>
	IP-POWER/XLR COMBI CABLE 3M* Code : B01362	Length: 3 m.	39€ <sup>incl. VAT</sup>
	IP-POWER/XLR COMBI CABLE 5M* Code : B01363	Length: 5 m.	49€ <sup>incl. VAT</sup>
<b>E</b>	POWERCON/XLR COMBI 3x1.5mm <sup>2</sup> CABLE 1M3 Code : B01263	1.3 m POWERCON Neutrik / XLR hybrid cable 3G1.5mm <sup>2</sup>	29.90€ <sup>incl. VAT</sup>
	POWERCON/XLR COMBI 3x1.5mm <sup>2</sup> CABLE 3M Code : B01264	3m POWERCON Neutrik / XLR hybrid cable 3G1.5mm <sup>2</sup>	36.90€ <sup>incl. VAT</sup>
	POWERCON/XLR COMBI 3x1.5mm <sup>2</sup> CABLE 5M Code : B01265	5m POWERCON Neutrik / XLR hybrid cable 3G1.5mm <sup>2</sup>	45.90€ <sup>incl. VAT</sup>
	POWERCON/XLR COMBI 3x1.5mm <sup>2</sup> CABLE 10M Code : B01266	10m POWERCON Neutrik / XLR hybrid cable 3G1.5mm <sup>2</sup>	69€ <sup>incl. VAT</sup>

\* Combination of a power cable 3 x 1.5 mm<sup>2</sup> (16 A max.) and a symmetrical shielded signal cable. Equipped with XLR male / female connectors and IP power.

# POWER CABLES



<b>A</b>	IECMF-1 Code : H9889	IEC male / female 1m cables	5,00€ <sup>Incl. VAT</sup>
	IECMF-3 Code : H9890	IEC male / female 3m cables	11,00€ <sup>Incl. VAT</sup>
	IECMF-5 Code : H9891	IEC male / female 5m cables	16,00€ <sup>Incl. VAT</sup>
	IECMF-7 Code : H9892	IEC male / female 7m cables	22,00€ <sup>Incl. VAT</sup>
<b>B</b>	CPCIN-1 Code : H10684	NAC3FCA / 3G1.5mm cable <sup>2</sup> / PC16A - 1m	28,70€ <sup>Incl. VAT</sup>
	CPCIN-2.5 Code : H10685	NAC3FCA / 3G1.5mm cable <sup>2</sup> / PC16A - 2.5m	34,00€ <sup>Incl. VAT</sup>
<b>C</b>	CPCLINK-0.5 Code : H10692	NAC3FCA / NAC3FCB 3G0.75mm cable <sup>2</sup> ET 3G2mm <sup>2</sup> - 0.5m	44,40€ <sup>Incl. VAT</sup>
	CPCLINK-1 Code : H10693	NAC3FCA / NAC3FCB 3G0.75mm cable <sup>2</sup> ET 3G2mm <sup>2</sup> - 1m	47,00€ <sup>Incl. VAT</sup>
	CPCLINK-1.5 Code : H10694	NAC3FCA / NAC3FCB 3G0.75mm cable <sup>2</sup> ET 3G2mm <sup>2</sup> - 1.5m	47,80€ <sup>Incl. VAT</sup>
<b>D</b>	IPCP-1 Code : H10725	Waterproof electrical connection cable for IPZOOM - 1m	32,00€ <sup>Incl. VAT</sup>
	IPCP-2 Code : H10726	Waterproof electrical connection cable for IPZOOM - 2m	35,00€ <sup>Incl. VAT</sup>
	IPCP-3 Code : H10776	Waterproof electrical connection cable for IPZOOM-3m	37€ <sup>Incl. VAT</sup>
	IPCP-5 Code : H10727	Waterproof electrical connection cable for IPZOOM - 5m	39,00€ <sup>Incl. VAT</sup>
<b>E</b>	ALIM315/3 Code : H9848	Extension cable with rubber plugs H07RN- F3G1.5 - 3m	14,80€ <sup>Incl. VAT</sup>
	ALIM315/5 Code : H9849	Extension cable with rubber plugs H07RN- F3G1.5 - 5m	21,60€ <sup>Incl. VAT</sup>
	ALIM315/10 Code : H9850	Extension cable with rubber plugs H07RN- F3G1.5 - 10m	38,30€ <sup>Incl. VAT</sup>
<b>F</b>	ALIM325/3 Code : H9851	Extension cable with rubber plugs H07RN- F3G2.5 - 3m	21,50€ <sup>Incl. VAT</sup>
	ALIM325/5 Code : H9852	Extension cable with rubber plugs H07RN- F3G2.5 - 5m	32,10€ <sup>Incl. VAT</sup>
	ALIM325/10 Code : H9853	Extension cable with rubber plugs H07RN- F3G2.5 - 10m	61,10€ <sup>Incl. VAT</sup>
<b>G</b>	MULT6E Code : H10841	European extension socket 6 outlets	7,95€ <sup>Incl. VAT</sup>
<b>H</b>	MULT4E Code : H10842	Power outlets 4 European outlets	6,95€ <sup>Incl. VAT</sup>
<b>I</b>	MULTIP6F Code : H10843	French extension socket 6 outlets - IP44	11,90€ <sup>Incl. VAT</sup>
<b>J</b>	MULTIP6E Code : H10844	European extension socket 6 outlets - IP44	12,90€ <sup>Incl. VAT</sup>
<b>K</b>	MULTIP4F Code : H10845	Power outlets 4 French sockets - IP44	10,90€ <sup>Incl. VAT</sup>
<b>L</b>	MULTIP4E Code : H10846	Power outlets 4 European outlets - IP44	11,90€ <sup>Incl. VAT</sup>
	IECEUR3 Code : H10869	IEC female / Europe male cable - 3m / 3G1mm <sup>2</sup>	7,90€ <sup>Incl. VAT</sup>
<b>M</b>	IECEUR5 Code : H10870	IEC female / Europe male cable - 5m / 3G1mm <sup>2</sup>	9,90€ <sup>Incl. VAT</sup>
	CPCIN3 Code : H10871	Europe male / SEETRONIC cable - 3m / 3G1.5mm <sup>2</sup>	22,00€ <sup>Incl. VAT</sup>
<b>N</b>	CPCIN5 Code : H10872	Europe male / SEETRONIC cable - 5m / 3G1.5mm <sup>2</sup>	28,00€ <sup>Incl. VAT</sup>
	CEE-CABLE-32A-5G6-10M* Code : B01392		104,90€ <sup>Incl. VAT</sup>
<b>O</b>	CEE-CABLE-32A-5G6-20M* Code : B01393		189,00€ <sup>Incl. VAT</sup>
	CEE-CABLE-32A-5G6-5M* Code : B01391		63,90€ <sup>Incl. VAT</sup>
	CEE-CABLE-63A-5G16-10M* Code : B01395		369,00€ <sup>Incl. VAT</sup>
<b>P</b>	CEE-CABLE-63A-5G16-20M* Code : B01396		699,00€ <sup>Incl. VAT</sup>
	CEE-CABLE-63A-5G16-5M* Code : B01394		219,00€ <sup>Incl. VAT</sup>

\*5-pole CEE extension cable with transparent heat-shrinkable sheath for custom labels.

<b>Q</b>	IEC Cable M/F 1M Code : B04151	IEC male and female cables	4,90€ <sup>Incl. VAT</sup>
	IEC Cable M/F 5M Code : B04152	IEC male and female cable	11,90€ <sup>Incl. VAT</sup>
<b>R</b>	MULTISOCKET4-F** Code : B01352		5,50€ <sup>Incl. VAT</sup>
<b>S</b>	MULTISOCKET4-G** Code : B01353		5,50€ <sup>Incl. VAT</sup>
<b>T</b>	MULTISOCKET4PRO-F-3M** Code : B01387		22,90€ <sup>Incl. VAT</sup>
	MULTISOCKET4PRO-F-5M** Code : B01389		26,90€ <sup>Incl. VAT</sup>
<b>U</b>	MULTISOCKET4PRO-G-3M** Code : B01388		22,90€ <sup>Incl. VAT</sup>
	MULTISOCKET4PRO-G-5M** Code : B01390		26,90€ <sup>Incl. VAT</sup>
<b>V</b>	POWER CABLE CEE7/7-IEC 2M Code : B01350	CEE7/7-IEC power cable 2M	7,99€ <sup>Incl. VAT</sup>
<b>W</b>	POWER CABLE CEE7/7-PowerCON 2M Code : B01351	Power cable CEE7/7 - PowerCON	14,90€ <sup>Incl. VAT</sup>
<b>X</b>	POWERCABLE-3G1,5-10M-F Code : B01377	Extension cable 3G1.5, 10m and French Schuko plug	19,00€ <sup>Incl. VAT</sup>
<b>Y</b>	POWERCABLE-3G1,5-10M-G Code : B01380	Extension cable 3G1.5, 10m and German Schuko plug	17,90€ <sup>Incl. VAT</sup>
<b>Z</b>	POWERCABLE-3G1,5-3M-F Code : B01375	Extension cable 3G1.5, 3m and French Schuko plug	6,50€ <sup>Incl. VAT</sup>
<b>A1</b>	POWERCABLE-3G1,5-3M-G Code : B01378	Extension cable 3G1.5, 3m and German Schuko plug	6,50€ <sup>Incl. VAT</sup>
<b>B1</b>	POWERCABLE-3G1,5-5M-F Code : B01376	Extension cable 3G1.5, 5m and French Schuko plug	9,90€ <sup>Incl. VAT</sup>
<b>C1</b>	POWERCABLE-3G1,5-5M-G Code : B01379	Extension cable 3G1.5, 5m and German Schuko plug	9,90€ <sup>Incl. VAT</sup>
<b>D1</b>	POWERCABLE-3G2,5-10M-F Code : B01382	Extension cable 3G2.5, 10m and French Schuko plug	28,00€ <sup>Incl. VAT</sup>
<b>E1</b>	POWERCABLE-3G2,5-10M-G Code : B01385	Extension cable 3G2.5, 10m and German Schuko plug	26,90€ <sup>Incl. VAT</sup>
<b>F1</b>	POWERCABLE-3G2,5-20M-F Code : B01383	Extension cable 3G2.5, 20m and French Schuko plug	49,00€ <sup>Incl. VAT</sup>
<b>G1</b>	POWERCABLE-3G2,5-20M-G Code : B01386	Extension cable 3G2.5, 20m and German Schuko plug	59,00€ <sup>Incl. VAT</sup>
<b>H1</b>	POWERCABLE-3G2,5-5M-F Code : B01381	Extension cable 3G2.5, 5m and French Schuko plug	13,90€ <sup>Incl. VAT</sup>
<b>I1</b>	POWERCABLE-3G2,5-5M-G Code : B01384	Extension cable 3G2.5, 5m and German Schuko plug	14,90€ <sup>Incl. VAT</sup>
<b>J1</b>	POWERCABLE-3G2,5-3M-F Code : B01397	Extension cable 3G2.5, 3m and French Schuko plug	9,90€ <sup>Incl. VAT</sup>
<b>K1</b>	POWERCABLE-3G2,5-3M-G Code : B01398	Extension cable 3G2.5, 3m and German Schuko plug	9,90€ <sup>Incl. VAT</sup>
<b>L1</b>	CABLE CASE Code : B03244	Extra solid flight case specially designed to carry cables and other heavy objects.	599,00€ <sup>Incl. VAT</sup>

\*\*4-outlet power distribution box with sliding mounting bracket and transparent heat-shrinkable sheath for custom labels.



# USB CABLES



<b>A</b>	CU/AMAF Code : H9271	USB2.0 A male / A female cable - 5m	17,70€ <sup>Incl. VAT</sup>
<b>B</b>	CU/AMBM-1 Code : H9272	USB2.0 A male / USB2.0 B male cable - 1m	10,00€ <sup>Incl. VAT</sup>
	CU/AMBM-5 Code : H9287	USB2.0 A male / USB2.0 B male cable - 5m	17,70€ <sup>Incl. VAT</sup>
<b>C</b>	USB2 A-B 2M Code : B01273	USB2 A-B 2M	6,50€ <sup>Incl. VAT</sup>
	USB2 A-B 3M Code : B01274	USB2 A-B 3M	6,90€ <sup>Incl. VAT</sup>

<b>D</b>	USB3 A-B 2M Code : B01275	USB3 A-B 2M	6,90€ <sup>Incl. VAT</sup>
	USB3 A-B 3M Code : B01276	USB3 A-B 3M	7,90€ <sup>Incl. VAT</sup>

# INSTALLATION CABLE AUDIO



<b>A</b>	PROMI/20 Code : H8099	6 mm black microphone cable - 100m coil	59,90€ <sup>Incl. VAT</sup>
<b>B</b>	PROMI/30 Code : H8100	6 mm black high quality microphone cable 100 m	89€ <sup>Incl. VAT</sup>
<b>C</b>	MEP/ASY Code : H8103	Flat cable 2 x 4 mm <sup>2</sup> asymmetrical black- 100 m coil	79,00€ <sup>Incl. VAT</sup>
<b>D</b>	MEP-2075 Code : H8104	HP flat cable 2 x 0.75mm <sup>2</sup> red and black - 100 m coil	65,00€ <sup>Incl. VAT</sup>
<b>E</b>	MEP-2150 Code : H8105	HP Flat Cable 2 x 1.5 mm <sup>2</sup> rouge et noir - bobine de 100 m	119,00€ <sup>Incl. VAT</sup>
<b>F</b>	MEP-2200 Code : H8106	HP Flat Cable 2 x 2mm <sup>2</sup> rouge et noir - bobine de 100 m	199,00€ <sup>Incl. VAT</sup>
<b>G</b>	PROHP-215 Code : H8107	HP 2 x 1.5 mm cable <sup>2</sup> black - coil 100 m	119€ <sup>Incl. VAT</sup>
<b>H</b>	PROHP-225 Code : H8108	HP 2 x 2.5 mm cable <sup>2</sup> black - coil 100 m	229,00€ <sup>Incl. VAT</sup>
<b>I</b>	PROHP-425 Code : H8109	HP 4 x 2.5 mm cable <sup>2</sup> black - coil 50 m	269,00€ <sup>Incl. VAT</sup>

<b>J</b>	PROHP-440 Code : H8110	HP 4 x 4 mm cable <sup>2</sup> black - 50 m coil	419,00€ <sup>Incl. VAT</sup>
<b>K</b>	DUOSOUND Code : H9855	Hybrid power cable 3 x 1.5 mm <sup>2</sup> + AUDIO - 50m	449,00€ <sup>Incl. VAT</sup>
<b>L</b>	SPR2150 Code : B01290	Round cable of very good quality 2x1.50mm <sup>2</sup> (100m coil)	109,00€ <sup>Incl. VAT</sup>
<b>M</b>	SPR2250 Code : B01291	Round cable of very good quality 2x2.50mm <sup>2</sup> (100m coil)	199,00€ <sup>Incl. VAT</sup>
<b>N</b>	SPR2400 Code : B01292	Round cable of very good quality 2x4.00mm <sup>2</sup> (50m coil)	149,00€ <sup>Incl. VAT</sup>
<b>O</b>	SPR4250 Code : B01293	Round cable of very good quality: 4x2.50mm <sup>2</sup> (50m coil)	209,00€ <sup>Incl. VAT</sup>
<b>P</b>	MC-01 Black Code : B01280	Symmetrical microphone cable of very good quality	55,90€ <sup>Incl. VAT</sup>
<b>Q</b>	MC-01 Blue Code : B01281	Symmetrical microphone cable of very good quality	55,90€ <sup>Incl. VAT</sup>
<b>R</b>	MC-01 Red Code : B01282	Symmetrical microphone cable of very good quality	55,90€ <sup>Incl. VAT</sup>



# VIDEO CABLES



<b>A</b>	HDMI 1M Code : B01270	High speed HDMI cable	7,90€ <sup>Incl. VAT</sup>
	HDMI 2M Code : B01271	High speed HDMI cable	8,90€ <sup>Incl. VAT</sup>
	HDMI 5M Code : B01272	High speed HDMI cable	12,90€ <sup>Incl. VAT</sup>

# LIGHT CABLE

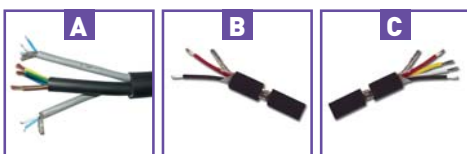

<b>A</b>	DUOLIGHT Code : H9854	Hybrid power cable 3 x 2.5 mm <sup>2</sup> + DMX - 50m	559,00€ <sup>Incl. VAT</sup>
<b>B</b>	DMX-DOUB Code : H8101	DMX digital cable 2 conductors black - price per metre	2,90€ <sup>Incl. VAT</sup>
<b>C</b>	DMX-QUAD Code : H8102	DMX digital cable 4 conductors black - price per meter	4,50€ <sup>Incl. VAT</sup>

# ELECTRICAL CABLE



<b>A</b>	TIT-315 Code : H6755	Titanex cable LENS H07RNF 3 x 1.5 mm <sup>2</sup> 100m coil	299,00€ <sup>Incl. VAT</sup>
<b>B</b>	TIT-325 Code : H6756	Titanex cable LENS H07RNF 3 x 2.5 mm <sup>2</sup> 100m coil	399,00€ <sup>Incl. VAT</sup>



# NEUTRIK® connectors

	NE8MC Code : H10446	Cat5e RJ45 cable plug body	4,30€ <sup>Incl. VAT</sup>
	NE8FDP Code : H10447	Female socket for CAT5e RJ45 cable	13,70€ <sup>Incl. VAT</sup>
	NE8FDPB Code : B01145	RJ45 feedthrough receptacle, black D-shape metal flange with the latch lock	14,19€ <sup>Incl. VAT</sup>
	NC-3-FXX Code : B01102	Neutrik XLR female connector for cable, 3-pin.	4,99€ <sup>Incl. VAT</sup>
	NC-3-FXX Code : H8846	3-pin NEUTRIK female XLR plug	4,99€ <sup>Incl. VAT</sup>
	NC-3-MXX Code : B01101	Neutrik XLR male connector for cable, 3-pin.	4,39€ <sup>Incl. VAT</sup>
	NC-3-MXX Code : H8848	3-pin NEUTRIK male XLR plug	4,39€ <sup>Incl. VAT</sup>
	NC-3-FX-HD Code : H10714	NEUTRIK 3-pole XLR female IP67 water-proof plug	9,00€ <sup>Incl. VAT</sup>
	NC-3-FX-HD Code : H10715	NEUTRIK 3-pole XLR male IP67 water-proof plug	9,00€ <sup>Incl. VAT</sup>
	NC-5-FXX Code : B01117	Neutrik XLR female connector for cable, 5-pin	11,90€ <sup>Incl. VAT</sup>
	NC-5-FXX Code : H8850	5-pin NEUTRIK female XLR plug	11,90€ <sup>Incl. VAT</sup>
	NC-5-MXX Code : B01118	Neutrik XLR male connector for cable, 5-pin	9,90€ <sup>Incl. VAT</sup>
	NC-5-MXX Code : H8851	5-pin male XLR plug NEUTRIK	9,90€ <sup>Incl. VAT</sup>
	NC-3-FD-L-1 Code : B01127	Female XLR chassis, lockable, D-size, 3-pin from Neutrik.	5,49€ <sup>Incl. VAT</sup>
	NC-3FDLX Code : H8852	NEUTRIK X series 3-pin female XLR socket	5,49€ <sup>Incl. VAT</sup>
	NC-3-MD-L-1 Code : B01128	Male XLR chassis, lockable, [D-size], 3 pins from Neutrik.	4,99€ <sup>Incl. VAT</sup>
	NC-3MDLX Code : H8853	NEUTRIK X series 3-pin male XLR socket	4,99€ <sup>Incl. VAT</sup>
	NC-5-FDLX Code : B01123	Neutrik D-size 5pin XLR-f CHASSIS	12,19€ <sup>Incl. VAT</sup>
	NC-5FDL1 Code : H4840	NEUTRIK D series 5-pin female XLR socket	12,19€ <sup>Incl. VAT</sup>
	NC-5-MDLX Code : B01124	Neutrik D-size 5pin XLR-m CHASSIS	9,90€ <sup>Incl. VAT</sup>
	NC-5MDL1 Code : H4841	NEUTRIK D series 5-pin male XLR socket	9,90€ <sup>Incl. VAT</sup>
	NA-USB Code : H8854	NEUTRIK D Series USB-A socket	8,10€ <sup>Incl. VAT</sup>
	NYS373-0 Code : H8855	NEUTRIK gold contact RCA plug - Black	2,90€ <sup>Incl. VAT</sup>
	NYS373-2 Code : H8856	NEUTRIK gold contact RCA plug - Red	2,90€ <sup>Incl. VAT</sup>
	NTP3RC Code : H7946	NEUTRIK angled stereo 3.5 JACK plug	4,70€ <sup>Incl. VAT</sup>
	NP-2-X Code : B01104	Neutrik 6.3mm JACK-m mono CABLE.	4,59€ <sup>Incl. VAT</sup>
	NP-2X Code : H8859	NEUTRIK male mono 6.35 JACK plug	4,59€ <sup>Incl. VAT</sup>
	NP-3-X Code : B01103	Neutrik 6.3mm JACK-m stereo CABLE	5,90€ <sup>Incl. VAT</sup>
	NP-3X Code : H8861	NEUTRIK male stereo 6.35 JACK plug	5,90€ <sup>Incl. VAT</sup>
	NJ-3-FC-6 Code : B01106	Neutrik 6.3mm JACK-f stereo CABLE	9,99€ <sup>Incl. VAT</sup>
	NJ-3FC6 Code : H4846	NEUTRIK female stereo 6.35 jack plug	9,99€ <sup>Incl. VAT</sup>
	NJ-3-FP-6C Code : B01105	Neutrik D-size stereo 6.3mm JACK-f CHASSIS	8,49€ <sup>Incl. VAT</sup>
	NJ-3FP6C Code : H4848	NEUTRIK D series female stereo 6.35 JACK socket	8,49€ <sup>Incl. VAT</sup>

	NP2C-SILENT Code : H8857	NEUTRIK anti-plock mono jack plug	12,60€ <sup>Incl. VAT</sup>
	NP2RX-SILENT Code : H8858	NEUTRIK anti-plock angled mono jack plug	13,80€ <sup>Incl. VAT</sup>
	NC-3FRX Code : H8863	3-pin NEUTRIK angled female XLR plug	9,80€ <sup>Incl. VAT</sup>
	NC-3MRX Code : H8865	3-pin NEUTRIK angled male XLR plug	8,50€ <sup>Incl. VAT</sup>
	NP2RX Code : B01147	Right Angle Mono Plug	4,49€ <sup>Incl. VAT</sup>
	NP-2RX Code : H4854	NEUTRIK angled male mono 6.35 JACK plug	4,49€ <sup>Incl. VAT</sup>
	NP-3RX Code : H4855	NEUTRIK angled male stereo 6.35 JACK plug	7,80€ <sup>Incl. VAT</sup>
	NL-2-FX Code : B01136	Neutrik Speakon CABLE, 2 contacts.	4,90€ <sup>Incl. VAT</sup>
	NL-2FX Code : H4856	NEUTRIK SPEAKON plug, 2 contacts	4,90€ <sup>Incl. VAT</sup>
	NL-4-FX Code : B01113	Neutrik Speakon CABLE, 4 contacts.	6,49€ <sup>Incl. VAT</sup>
	NL-4FX Code : H4857	NEUTRIK X series SPEAKON plug, 4 contacts	6,20€ <sup>Incl. VAT</sup>
	NL-4-MMX Code : B01116	Neutrik 2x Speakon ADAPTER, 4 contacts.	7,99€ <sup>Incl. VAT</sup>
	NL-4MMX Code : H4859	NEUTRIK X series SPEAKON coupler, 4 contacts	7,99€ <sup>Incl. VAT</sup>
	NL-2MP Code : H4861	NEUTRIK D series SPEAKON socket, 2 contacts	2,90€ <sup>Incl. VAT</sup>
	NL-4-MP Code : B01115	Neutrik Speakon CHASSIS, D-size, 4 contacts.	2,59€ <sup>Incl. VAT</sup>
	NL-4MP Code : H4862	NEUTRIK 4-way SPEAKON 2-way socket	2,59€ <sup>Incl. VAT</sup>
	NL-4-MP-R Code : B01114	Neutrik Speakon BIG CHASSIS, 4 contacts.	4,29€ <sup>Incl. VAT</sup>
	NL-4MPR Code : H4863	NEUTRIK SPEAKON socket, 4 contacts, EP format	4,29€ <sup>Incl. VAT</sup>
	NAC3FX-W Code : B01132	PowerCON TRUE1 locking female cable connector with power-in and screw terminals.	9,90€ <sup>Incl. VAT</sup>
	NAC3FX-W Code : H10448	Powercon True one female plug	9,90€ <sup>Incl. VAT</sup>
	NAC3MX-W Code : B01131	PowerCON TRUE1 locking male cable connector with power-out and screw terminals.	9,90€ <sup>Incl. VAT</sup>
	NAC3MX-W Code : H10449	Powercon True one male plug	9,90€ <sup>Incl. VAT</sup>
	NAC3MPX Code : B01134	NEUTRIK PowerCON TRUE1 appliance inlet connector with 1/4" flat tab terminals.	4,90€ <sup>Incl. VAT</sup>
	NAC3MPX Code : H10450	Powercon True one male socket	4,90€ <sup>Incl. VAT</sup>
	NAC3FPX Code : B01135	NEUTRIK PowerCON TRUE1 appliance outlet connector with 1/4" flat tab terminals.	8,19€ <sup>Incl. VAT</sup>
	NAC3FPX Code : H10451	Powercon True one female socket	8,19€ <sup>Incl. VAT</sup>
	NAC3PX Code : B01133	PowerCON TRUE1 appliance inlet-outlet combination with 1/4" flat tab terminals.	11,90€ <sup>Incl. VAT</sup>
	NAC-3-FCA Code : B01125	Neutrik PowerCon inlet (blue) CABLE	8,90€ <sup>Incl. VAT</sup>
	NAC-3FCA Code : H4865	NEUTRIK 240V 20A male power input plug, 3 contacts	8,90€ <sup>Incl. VAT</sup>
	NAC-3-FCB Code : B01129	Neutrik PowerCon outlet (grey) CABLE	8,90€ <sup>Incl. VAT</sup>
	NAC-3FCB Code : H4866	NEUTRIK 240V 20A male power output plug, 3 contacts	8,90€ <sup>Incl. VAT</sup>
	NAC-3-MPA Code : B01126	Neutrik D-size PowerCon inlet (blue) CHASSIS	4,90€ <sup>Incl. VAT</sup>
	NAC-3MPA Code : H4867	NEUTRIK 240V 20A power input socket, 3 contacts	4,90€ <sup>Incl. VAT</sup>
	NAC-3-MPB Code : B01130	Neutrik D-size PowerCon outlet (grey) CHASSIS	4,59€ <sup>Incl. VAT</sup>
	NAC-3MPB Code : H4868	NEUTRIK 240V 20A power output socket, 3 contacts	4,59€ <sup>Incl. VAT</sup>

	NF2D0 Code : H10452	RCA socket, black, D format	5,90€ <sup>Incl. VAT</sup>
	NF2D2 Code : H10453	RCA socket, red, D format	5,90€ <sup>Incl. VAT</sup>
	NF2D-B-2 Code : B01139	Red RCA socket D format	6,49€ <sup>Incl. VAT</sup>
	NF2D-B-9 Code : B01138	RCA socket, white, D format	6,49€ <sup>Incl. VAT</sup>
	NA-3F5M Code : H4869	NEUTRIK DMX XLR 3 fem. / XLR 5 male adapter	16,00€ <sup>Incl. VAT</sup>
	NA-3M5F Code : H4870	NEUTRIK DMX XLR 3 male / XLR 5 female adapter	17,30€ <sup>Incl. VAT</sup>
	SCDR Code : B01144	Rear protection of size D	2,39€ <sup>Incl. VAT</sup>
	XXCR Code : B01146	Clear ring	0,20€ <sup>Incl. VAT</sup>
	DBA Code : B01119	cover for Neutrik D chassis	1,09€ <sup>Incl. VAT</sup>

	NC3FDLXBAG Code : B01141	X series 3-pin female XLR socket / black - NEUTRIK	5,59€ <sup>Incl. VAT</sup>
	NC3MDLXBAG Code : B01140	X series 3-pin male XLR socket / black - NEUTRIK	5,49€ <sup>Incl. VAT</sup>
	NC3FXXBAG Code : B01143	3-pin female XLR plug / black - NEUTRIK	5,49€ <sup>Incl. VAT</sup>
	NC3MXXBAG Code : B01142	3-pin female XLR plug / black - NEUTRIK	4,59€ <sup>Incl. VAT</sup>
	NAUSB-W-B Code : B01148	D series USB-A socket / black - NEUTRIK	8,19€ <sup>Incl. VAT</sup>

# ELECTRICAL CONNECTORS

	CEE100 Code : H0227	CEE 22 chassis - male	1,50€ <sup>Incl. VAT</sup>
	CEE300 Code : H0225	CEE 22 plug - male	1,90€ <sup>Incl. VAT</sup>
	FIC/MAL Code : H1804	Male plastic plug 2 poles + earth	3,00€ <sup>Incl. VAT</sup>
	FIC/CAH/MAL Code : H1806	Male rubber plug 2 poles + earth	8,70€ <sup>Incl. VAT</sup>
	FIC/SCHU/MAL Code : H8131	Male rubber plug IP44 schuko	7,20€ <sup>Incl. VAT</sup>
	ADAPTER IP-POWER TO POWERCON* Code : B01360		19,90€ <sup>Incl. VAT</sup>
	SAC3FX Code : H10720	Waterproof Power In plug IP65 SEETRONIC	8,00€ <sup>Incl. VAT</sup>

	CEE200 Code : H1659	CEE 22 chassis female	1,70€ <sup>Incl. VAT</sup>
	CEE400 Code : H0226	CEE 22 plug - female	2,10€ <sup>Incl. VAT</sup>
	FIC/FEM Code : H1805	Female plastic plug 2 poles + earth	3,60€ <sup>Incl. VAT</sup>
	FIC/CAH/FEM Code : H1807	Female plug 2 poles + earth	12,40€ <sup>Incl. VAT</sup>
	FIC/SCHU/FEM Code : H8132	Female rubber plug IP44 standard French	11,40€ <sup>Incl. VAT</sup>
	ADAPTER POWERCON TO IP-POWER Code : B01365		19,90€ <sup>Incl. VAT</sup>
	SAC3MX Code : H10721	Waterproof Power Out plug IP65 SEETRONIC	9,00€ <sup>Incl. VAT</sup>
	BT-16FS-F Code : B01406	Blue plug with IP44 cover, 230V/16A FRA/BEL	1,90€ <sup>Incl. VAT</sup>

\* IP-POWER (input)/POWERCON (output) conversion adapter from IP class to normal Powercon connector.

\*\* POWERCON (input) / IP-POWER (output) conversion adapter from normal Powercon connector to IP class connector.











































# CONNECTORS

	J35ST Code : H10876	Chrome stereo 3.5 jack plug	2,20€ <sup>Incl. VAT</sup>
	J35STVIS Code : H10828	Chrome stereo 3.5 jack plug with screws	2,50€ <sup>Incl. VAT</sup>
	FXF/CH Code : H2487	AUDIOPHONY XLR female plug - chrome finish	1,50€ <sup>Incl. VAT</sup>
	FXF/NO Code : H7932	AUDIOPHONY X female plug - Black	1,50€ <sup>Incl. VAT</sup>
	FXM/CH Code : H2488	AUDIOPHONY XLR male plug - chrome finish	1,20€ <sup>Incl. VAT</sup>
	FXM/NO Code : H7933	AUDIOPHONY X male plug - Black	1,20€ <sup>Incl. VAT</sup>
	XFC-103 Code : H6586	AUDIOPHONY D Series XLR female chassis	1,40€ <sup>Incl. VAT</sup>
	XMC-103 Code : H6585	AUDIOPHONY D series XLR male chassis	1,30€ <sup>Incl. VAT</sup>
	XMK-105 Code : H6587	5-pin male XLR plug for the AUDIOPHONY DMX	1,90€ <sup>Incl. VAT</sup>
	XFK-105 Code : H6588	5-pin female XLR plug for the AUDIOPHONY DMX	2,20€ <sup>Incl. VAT</sup>
	FJM/CH Code : H2495	AUDIOPHONY mono 6.35mm jack plug - chrome finish	1,40€ <sup>Incl. VAT</sup>
	FJS/CH Code : H2496	AUDIOPHONY stereo 6.35mm jack plug - chrome finish	1,60€ <sup>Incl. VAT</sup>
	J350/MO Code : H7936	AUDIOPHONY mono 6.35mm Jack female plug pro	3,40€ <sup>Incl. VAT</sup>
	J350/STE Code : H7937	AUDIOPHONY professional stereo jack female plug - 6.35mm	3,40€ <sup>Incl. VAT</sup>
	J700 Code : H7939	Stereo 6.35 mm jack female chassis with AUDIOPHONY lock	3,60€ <sup>Incl. VAT</sup>
	RCA910/RO Code : H7940	Red male RCA plug for AUDIOPHONY professional cable	1,30€ <sup>Incl. VAT</sup>
	RCA910/NO Code : H7941	Black male RCA plug for AUDIOPHONY professional cable	1,30€ <sup>Incl. VAT</sup>
	RCA920/RO Code : H7942	Red female RCA plug for AUDIOPHONY professional cable	1,30€ <sup>Incl. VAT</sup>
	RCA920/NO Code : H7943	Black female RCA plug for AUDIOPHONY professional cable	1,30€ <sup>Incl. VAT</sup>

	BANA100/NO Code : H1653	AUDIOPHONY male banana plug - Black	0,80€ <sup>Incl. VAT</sup>
	BANA100/RO Code : H1652	AUDIOPHONY male banana plug - Red	0,80€ <sup>Incl. VAT</sup>
	BANA200/NO Code : H1655	AUDIOPHONY female banana chassis - Black	0,90€ <sup>Incl. VAT</sup>
	BANA200/RO Code : H1654	AUDIOPHONY female banana chassis - Red	0,90€ <sup>Incl. VAT</sup>
	BANA150/NO Code : H6595	AUDIOPHONY connector for amplifier terminal block, black	2,00€ <sup>Incl. VAT</sup>
	BANA150/RO Code : H6596	AUDIOPHONY connector for amplifier terminal block, red	1,90€ <sup>Incl. VAT</sup>
	BANA400/NO Code : H7944	AUDIOPHONY 2 x female banana chassis - 1 Red / 1 Black	2,30€ <sup>Incl. VAT</sup>
	XLR female CHASSIS D-SIZE Code : B01306	XLR female chassis	2,69€ <sup>Incl. VAT</sup>
	XLR male CHASSIS D-SIZE Code : B01305	XLR male chassis	1,99€ <sup>Incl. VAT</sup>
	SC3FXW-W Code : H10716	XLR 3P female waterproof plug IP65 SEETRONIC	8,00€ <sup>Incl. VAT</sup>
	SC3MXW-W Code : H10717	XLR 3P waterproof male plug IP65 SEETRONIC	6,00€ <sup>Incl. VAT</sup>
	SC5FXW-W Code : H10718	XLR 5P female waterproof plug IP65 SEETRONIC	9,00€ <sup>Incl. VAT</sup>
	SC5MXW-W Code : H10719	XLR 5P waterproof male plug IP65 SEETRONIC	8,00€ <sup>Incl. VAT</sup>
	PROLOCK female CABLE Code : B01308	Female Pro Lock Connector	5,90€ <sup>Incl. VAT</sup>
	PROLOCK male CABLE Code : B01307	Pro Lock Male Connector	5,49€ <sup>Incl. VAT</sup>
	RCA female CABLE Code : B01311	RCA Female Connector	2,89€ <sup>Incl. VAT</sup>
	RCA male CABLE Code : B01310	RCA Male Connector	2,90€ <sup>Incl. VAT</sup>
	STEREOJACK 6.3mm FEMALE CABLE Code : B01302	stereo female 6.3mm jack	5,90€ <sup>Incl. VAT</sup>
	STEREOJACK 6.3mm MALE CABLE Code : B01301	Stereo male 6.3mm jack	3,39€ <sup>Incl. VAT</sup>
	XLR female CABLE Code : B01304	XLR female Connector	2,49€ <sup>Incl. VAT</sup>
	XLR male CABLE Code : B01303	XLR male Connector	2,49€ <sup>Incl. VAT</sup>

# ADAPTERS

	ADAPT400 Code : H0505	AUDIOPHONY RCA female / mono male 6.35 jack adapter	1,10€ <sup>Incl. VAT</sup>
	ADAPT600 Code : H1656	AUDIOPHONY 2 RCA female / 1 RCA male adapter	1,60€ <sup>Incl. VAT</sup>
	ADAPT750 Code : H7927	AUDIOPHONY 2 x RCA female / 2 RCA female adapter	1,80€ <sup>Incl. VAT</sup>
	ADAPT850 Code : H0506	AUDIOPHONY 2 female 6.35 jack / 1 male 6.35 jack adapter	1,50€ <sup>Incl. VAT</sup>
	ADAPT1000 Code : H7928	AUDIOPHONY stereo female 3.5 jack / stereo male 6.35 kack adapter	1,30€ <sup>Incl. VAT</sup>
	ADAPT1105 Code : H7931	AUDIOPHONY stereo RCA female / stereo male 3.5 jack adapter	1,50€ <sup>Incl. VAT</sup>
	ADA/XMXM Code : H2500	AUDIOPHONY XLR male / XLR male adapter	3,00€ <sup>Incl. VAT</sup>
	ADA/XFJF Code : H2502	AUDIOPHONY XLR female / female jack adapter	3,00€ <sup>Incl. VAT</sup>
	ADA/XFRM Code : H2504	AUDIOPHONY XLR female / RCA male adapter	3,00€ <sup>Incl. VAT</sup>
	ADA/XFRF Code : H2506	AUDIOPHONY XLR female / RCA female adapter	3,00€ <sup>Incl. VAT</sup>
	ADA/XFJM Code : H6560	AUDIOPHONY XLR female / mono male jack adapter	3,00€ <sup>Incl. VAT</sup>
	ADA/XMJM Code : H6562	AUDIOPHONY XLR male / mono male jack adapter	3,00€ <sup>Incl. VAT</sup>
	ADA/XF5XM <sup>3</sup> Code : H7925	AUDIOPHONY DMX XLR female 5 pins / XLR male 3 pins adapter	4,10€ <sup>Incl. VAT</sup>
	AS/SF-SF Code : H6583	AUDIOPHONY speaker extension adapter, 2 contacts	6,60€ <sup>Incl. VAT</sup>
	RCA female/MONOJACK adapter Code : B01312		1,39€ <sup>Incl. VAT</sup>
	RCAI/XLRf adapter Code : B01320		5,90€ <sup>Incl. VAT</sup>
	XLR female/ST.JACK adapter Code : B01314		5,50€ <sup>Incl. VAT</sup>
	XLR female/XLR female adapter Code : B01317		6,50€ <sup>Incl. VAT</sup>
	XLR male/ST.JACK female adapter Code : B01315		5,99€ <sup>Incl. VAT</sup>
	XLRmale 3P / XLRfem 5P adapter Code : B01277		6,90€ <sup>Incl. VAT</sup>
	MONOJACK 6.3mm MALE CABLE Code : B01300		2,89€ <sup>Incl. VAT</sup>
	ADAPT500 Code : H0766	AUDIOPHONY female 6.35 jack / RCA male adapter	1,30€ <sup>Incl. VAT</sup>
	ADAPT700 Code : H1657	AUDIOPHONY RCA female / RCA female adapter	0,80€ <sup>Incl. VAT</sup>
	ADAPT800 Code : H0767	AUDIOPHONY female 6.35 jack / female 6.35 jack adapter	1,50€ <sup>Incl. VAT</sup>
	ADAPT900 Code : H1658	AUDIOPHONY 2 RCA female / 1 stereo male 6.35 jack adapter	1,50€ <sup>Incl. VAT</sup>
	ADAPT1005 Code : H7929	AUDIOPHONY stereo female 6.35 jack / stereo male 3.5 jack adapter	1,30€ <sup>Incl. VAT</sup>
	ADAPT1200 Code : H9278	AUDIOPHONY stereo male 6.35 jack to 2 x 3 jack adapter	2,20€ <sup>Incl. VAT</sup>
	ADA/XFXF Code : H2501	AUDIOPHONY XLR female / XLR female adapter	3,90€ <sup>Incl. VAT</sup>
	ADA/XMJF Code : H2503	AUDIOPHONY XLR male / female jack adapter	3,00€ <sup>Incl. VAT</sup>
	ADA/XMRM Code : H2505	AUDIOPHONY XLR male / RCA male adapter	3,00€ <sup>Incl. VAT</sup>
	ADA/XMRF Code : H2507	AUDIOPHONY XLR male / RCA female adapter	3,00€ <sup>Incl. VAT</sup>
	ADA/XFJMS Code : H6561	AUDIOPHONY XLR female / stereo male jack adapter	3,00€ <sup>Incl. VAT</sup>
	ADA/XMJMS Code : H6563	AUDIOPHONY XLR male / stereo male jack adapter	3,00€ <sup>Incl. VAT</sup>
	ADA/XM5XF3 Code : H7926	AUDIOPHONY DMX XLR male 5 pins / XLR female 3 pins adapter	4,10€ <sup>Incl. VAT</sup>
	Adapter JACKf/JACKf Code : B01319	2x female jack adapter (stereo) with lock	9,50€ <sup>Incl. VAT</sup>
	RCA/RCA adapter Code : B01309	Double RCA female / female adapter	2,99€ <sup>Incl. VAT</sup>
	RCAI/XLRm adapter Code : B01321	Adapter RCAI/XLRm	5,99€ <sup>Incl. VAT</sup>
	XLR female/ST.JACK female adapter Code : B01316		5,99€ <sup>Incl. VAT</sup>
	XLR male/ST.JACK adapter Code : B01313	XLR male / stereo male jack adapter	5,50€ <sup>Incl. VAT</sup>
	XLR male/XLR male adapter Code : B01318		4,90€ <sup>Incl. VAT</sup>
	XLRmale 5P / XLRfem 3P adapter Code : B01278		6,50€ <sup>Incl. VAT</sup>
	HEADPHONE ADAPTER Code : B01322	Universal headphone adapter	2,49€ <sup>Incl. VAT</sup>





















# CONSTRUCTION

	<b>COIN2PGM</b> Code : H0735	2-legged metal corner - large model	2,30€ <sup>Incl. VAT</sup>
	<b>COIN3P</b> Code : H0422	3-legged metal corner - medium model	1,60€ <sup>Incl. VAT</sup>
	<b>POIGNSURF</b> Code : H0279	Recessed spring surface handle	6,90€ <sup>Incl. VAT</sup>
	<b>POIGNMARCH/PM</b> Code : H4650	Metal Marshal handle - 220 x 160 x 60 mm	9,50€ <sup>Incl. VAT</sup>
	<b>ROUE100</b> Code : H0288	Swivel caster diameter 100 mm	14,20€ <sup>Incl. VAT</sup>
	<b>GRENOUILLE</b> Code : H0698	Draw bolt	2,70€ <sup>Incl. VAT</sup>
	<b>PAPILLONGM</b> Code : H0268	Large butterfly latch	15,60€ <sup>Incl. VAT</sup>
	<b>ECROUCAGE</b> Code : H0270	Cage nut for PROFILRACK	0,30€ <sup>Incl. VAT</sup>
	<b>VISRACK/16</b> Code : H0271	Cage nut screw diameter 6 mm length 16 mm	0,30€ <sup>Incl. VAT</sup>
	<b>RENFORT</b> Code : H0290	Metal corner reinforcement	0,50€ <sup>Incl. VAT</sup>
	<b>VCA512</b> Code : H8882	5x12 fluted rivet (box of 100)	9,70€ <sup>Incl. VAT</sup>
	<b>V561</b> Code : H8880	Black flat plastic washer - 5.5 x 10mm (per 100pcs)	6,40€ <sup>Incl. VAT</sup>
	<b>CORN3020</b> Code : H0287	Aluminium angle 30 x 20 mm - 2 m bar	5,50€ <sup>Incl. VAT</sup>
	<b>HYBRIDE10</b> Code : H0284	Aluminium hybrid profile - 2 m bar	6,70€ <sup>Incl. VAT</sup>
	<b>TOLE1U-NO</b> Code : H0736	19" panel height 1 unit	5,70€ <sup>Incl. VAT</sup>
	<b>TOLE3U-NO</b> Code : H0738	19" panel metal height 3 units	11,00€ <sup>Incl. VAT</sup>
	<b>TOL12XLR</b> Code : H0423	19" panel 1 unit for 6 XLR male chassis and 6 XLR female chassis	8,00€ <sup>Incl. VAT</sup>
	<b>TOLE2UV-NO</b> Code : H0367	19" panel, height 2 units, vented - special aeration	9,80€ <sup>Incl. VAT</sup>

	<b>COIN3PPM</b> Code : H0274	3-legged metal corner - small model	1,10€ <sup>Incl. VAT</sup>
	<b>COIN3PGM</b> Code : H0734	3-legged metal corner - large model	2,00€ <sup>Incl. VAT</sup>
	<b>POIGNRENOI</b> Code : H0280	Recessed spring return handle	6,50€ <sup>Incl. VAT</sup>
	<b>POIGNMARCH/GM</b> Code : H4652	Marshal handle, large model - 280 x 160 x 60 mm	10,60€ <sup>Incl. VAT</sup>
	<b>ROUE100FREIN</b> Code : H0266	Swivel caster diameter 100 mm - with brake	19,40€ <sup>Incl. VAT</sup>
	<b>PAPILLONPM</b> Code : H0287	Medium butterfly latch	8,50€ <sup>Incl. VAT</sup>
	<b>CHARNDEG</b> Code : H0289	Detachable metal hinge, large model	2,00€ <sup>Incl. VAT</sup>
	<b>VISRACK/12</b> Code : H3085	Rack screw diameter 6 mm length 12 mm	0,20€ <sup>Incl. VAT</sup>
	<b>TAMPON</b> Code : H0273	Rubber foot, large model	0,80€ <sup>Incl. VAT</sup>
	<b>VCA412</b> Code : H8881	4x12 fluted rivet (box of 100)	7,90€ <sup>Incl. VAT</sup>
	<b>VCA516</b> Code : H8883	5x16 fluted rivet (box of 100)	11,30€ <sup>Incl. VAT</sup>
	<b>CORN2020</b> Code : H0283	Aluminium angle 20 x 20 mm - 2 m bar	3,00€ <sup>Incl. VAT</sup>
	<b>CORN3030</b> Code : H0282	Aluminium angle 30 x 30 mm - 2 m bar	5,00€ <sup>Incl. VAT</sup>
	<b>PROFILRACK</b> Code : H0281	Sliding rack profile - 2 m bar	17,50€ <sup>Incl. VAT</sup>
	<b>TOLE2U-NO</b> Code : H0737	19" panel height 2 units	8,20€ <sup>Incl. VAT</sup>
	<b>TOLE4U-NO</b> Code : H0739	19" panel metal height 4 units	13,80€ <sup>Incl. VAT</sup>
	<b>TOLE1UV-NO</b> Code : H0368	19" panel, height 1 unit, vented	7,90€ <sup>Incl. VAT</sup>
	<b>ETAGÈREZU</b> Code : H1626	Metal shelf height 2 units	39,50€ <sup>Incl. VAT</sup>

# CONSTRUCTION

	<b>JB1200</b> Code : B00930	JB SYSTEMS Large recessed handle for speaker	2,49€ <sup>Incl. VAT</sup>
	<b>JB6</b> Code : B00921	JB SYSTEMS Small recessed handle for speaker	0,89€ <sup>Incl. VAT</sup>
	<b>JB8</b> Code : B00932	JB SYSTEMS Plastic protection corner for speaker	0,79€ <sup>Incl. VAT</sup>
	<b>SPEAKER GRILL 10inch</b> Code : B00910	Strong black metal grill	1,89€ <sup>Incl. VAT</sup>
	<b>SPEAKER GRILL 15inch</b> Code : B00912	Strong black metal grid	4,49€ <sup>Incl. VAT</sup>
	<b>SPEAKER GRILL 8inch</b> Code : B00909	Strong black metal grid	1,39€ <sup>Incl. VAT</sup>
	<b>TE20</b> Code : B00918	Connection plate with 2x Speakon compatible connector <sup>®</sup> and 2 screw connectors	9,90€ <sup>Incl. VAT</sup>
	<b>MS-00</b> Code : B03189	JV CASE 4x M6x16 + 4x plastic washers + 4x cage nut 2.2mm	1,99€ <sup>Incl. VAT</sup>
	<b>MS-02</b> Code : B03163	JV CASE 4x M6x16 + 4x plastic washers + 4x cage nut 1.5mm	1,99€ <sup>Incl. VAT</sup>
	<b>MS-04</b> Code : B03165	JV CASE 12x screw rack M6x16 + 12x plastic washers	2,19€ <sup>Incl. VAT</sup>
	<b>MS-07</b> Code : B03190	JV CASE Set 50x M3 screws/nuts for mounting Conn. of size D.	3,59€ <sup>Incl. VAT</sup>
	<b>RACK DRAWER 2U</b> Code : B03194	JV CASE 19" 2U drawer for rack	43,90€ <sup>Incl. VAT</sup>
	<b>RACK TRAY 1U</b> Code : B03197	JV CASE 19" 1U shelf	17,50€ <sup>Incl. VAT</sup>
	<b>RP 0.5U - 1/2U Rack panel</b> Code : B03142	JV CASE 19" panel.	4,90€ <sup>Incl. VAT</sup>
	<b>RP 1U/V - 1U ventilation rack panel</b> Code : B03147	Vented 19" panel 1U	6,90€ <sup>Incl. VAT</sup>
	<b>RP 2U - 2U Rack panel</b> Code : B03144	19" panel 2U	8,29€ <sup>Incl. VAT</sup>
	<b>RP 2U/V - 2U ventilation rack panel</b> Code : B03148	Ventilated 19" panel 2U	9,90€ <sup>Incl. VAT</sup>

	<b>JB14</b> Code : B00926	JB SYSTEMS bass tube-Recessed bass-reflex tube for speaker	0,79€ <sup>Incl. VAT</sup>
	<b>JB7</b> Code : B00922	JB SYSTEMS Rubber foot for speaker	0,79€ <sup>Incl. VAT</sup>
	<b>SA65</b> Code : B00735	JB SYSTEMS 35mm metal adapter for speaker stands	4,19€ <sup>Incl. VAT</sup>
	<b>SPEAKER GRILL 12inch</b> Code : B00911	Strong black metal grid	2,99€ <sup>Incl. VAT</sup>
	<b>SPEAKER GRILL 18inch</b> Code : B00913	Strong black metal grid	7,49€ <sup>Incl. VAT</sup>
	<b>TE10</b> Code : B00915	Connection plate for loudspeaker with 2 terminal blocks	2,39€ <sup>Incl. VAT</sup>
	<b>A.CONTROLLER/ALU</b> Code : B03187	Adapter for 2U/3U controllers	5,59€ <sup>Incl. VAT</sup>
	<b>MS-01</b> Code : B03160	JV CASE 4x M6x16 + 4x plastic washers + 4x cage nut 3mm	1,99€ <sup>Incl. VAT</sup>
	<b>MS-03</b> Code : B03164	JV CASE 20x black PVC washers M6	1,90€ <sup>Incl. VAT</sup>
	<b>MS-06</b> Code : B03178	JV CASE 12x M6 bolt x20 + 12x M6 nuts	2,90€ <sup>Incl. VAT</sup>
	<b>MS-08 50x M4x16 bold-Mennekes</b> Code : B03191	Set 50x M4 screws/nuts for mounting AC outlet.	3,90€ <sup>Incl. VAT</sup>
	<b>RACK DRAWER 3U</b> Code : B03196	JV CASE 19" 3U drawer for rack	55,00€ <sup>Incl. VAT</sup>
	<b>RACK TRAY 2U</b> Code : B03198	JV CASE 19" 2U shelf	21,90€ <sup>Incl. VAT</sup>
	<b>RP 1U - 1U Rack panel</b> Code : B03143	19" panel 1U	5,90€ <sup>Incl. VAT</sup>
	<b>RP 1U/XLR - XLR (D-size)</b> Code : B03149	19" panel 1U for 12 x XLR	6,90€ <sup>Incl. VAT</sup>
	<b>RP 2U/PC-8</b> Code : B03181	19" 2 units rack panel for 8x Blue Power Outlet	9,90€ <sup>Incl. VAT</sup>
	<b>RP 3U - 3U Rack panel</b> Code : B03145	19" panel 3U	9,90€ <sup>Incl. VAT</sup>







# LOUDSPEAKERS AND FILTERS

	SCX-12400 Code : B00850	SYNQ Powerful coaxial speaker of 400 W + 45 W of 12" + 1.75" and 60° x 40°.	329,00€ <sup>Incl. VAT</sup>
	JODR-20 Code : H9900	1 inch compression driver for JOGGER60	35,00€ <sup>Incl. VAT</sup>
	CRDR-20 Code : H9897	1.5 inch compression driver for CROSSER180	59,00€ <sup>Incl. VAT</sup>
	SRDR12 Code : H10164	1.35 inch 50W 8 Ohm driver for SR12A and SR15A	45,00€ <sup>Incl. VAT</sup>
	DIA/ACDR-30 Code : H8839	Diaphragm for ACDR-30	29,00€ <sup>Incl. VAT</sup>
	SDR-50 Code : H9815	Driver for S8 and S10	79,00€ <sup>Incl. VAT</sup>
	MOJOLINE-275 Code : H10586	2.75-inch tweeter for MOJO500LINE	29,00€ <sup>Incl. VAT</sup>
	CDR-20 Code : H10315	1-inch 20W 8 Ohm tweeter for CR80A	22,00€ <sup>Incl. VAT</sup>
	JB330 Code : B00801	85x85mm piezo tweeter	1,49€ <sup>Incl. VAT</sup>
	JB660 Code : B00804	161x94mm dual piezo tweeter	3,49€ <sup>Incl. VAT</sup>
	PTX34 Code : B00685	HF Driver: 1.50" - 50W 8 Ohm	39,00€ <sup>Incl. VAT</sup>
	SXDR-50 Code : H10853	1.35-inch driver for SX12A and SX15A speakers	49,00€ <sup>Incl. VAT</sup>
	AXO-AC08 Code : H9631	Passive filter for ACUTE08 passive	22,00€ <sup>Incl. VAT</sup>
	AXO-S8 Code : H9725	Filter for S8	35,00€ <sup>Incl. VAT</sup>
	AXO-COMPACT Code : H9399	2-way filter for COMPACT satellite	19,00€ <sup>Incl. VAT</sup>
	AXO-SR10P Code : H10320	2-way filter for SR10P speaker	29,00€ <sup>Incl. VAT</sup>
	AXO-SR15P Code : H10322	2-way filter for SR15P speaker	29,00€ <sup>Incl. VAT</sup>
	AXOHL Code : H10591	2-way passive filter for HL-4	29,00€ <sup>Incl. VAT</sup>
	CN-3 Code : B00615	High pass filter for 2-way system (X-over freq. : 7kHz, Slope: 12dB/oct RMS power: 100W)	4,90€ <sup>Incl. VAT</sup>
	CN-9 Code : B00814	2 way professional filter (X-over freq. : 2kHz, Slope: 12dB/oct, RMS power: 200W)	29,90€ <sup>Incl. VAT</sup>
	SCX-15450 Code : B00851	SYNQ Powerful 450W + 60W coaxial speaker of 15" + 1.75" and 60°x40°	369,00€ <sup>Incl. VAT</sup>
	SPDR-20 Code : H9639	1 inch compression driver for SPRINTER120	22,00€ <sup>Incl. VAT</sup>
	SRDR10 Code : H10163	1 inch driver for SR10A speaker	22,00€ <sup>Incl. VAT</sup>
	ACDR-30 Code : H8838	Driver for COMPACT, SATCOM16, S6, D12 and D15 satellites	45,00€ <sup>Incl. VAT</sup>
	OCDR-20 Code : H9400	COMPACT, SATCOM16, S6, D12 and D15 satellite engine	25,00€ <sup>Incl. VAT</sup>
	HLTR Code : H10590	8 Ohm ribbon tweeter for HL-4	129,00€ <sup>Incl. VAT</sup>
	CODR-20 Code : H10309	1-inch 20W 8 Ohm tweeter for COMPACT-500 satellite	35,00€ <sup>Incl. VAT</sup>
	HT30 Code : B00806	1" capton 150W 8 Ohm bullet tweeter	15,90€ <sup>Incl. VAT</sup>
	JB550 Code : B00803	187x80mm piezo tweeter	2,90€ <sup>Incl. VAT</sup>
	PH2 Code : B00823	Horn for PTX34 and PTX44	19,00€ <sup>Incl. VAT</sup>
	PTX44 Code : B00686	HF Driver: 1.75" - 50W 8ohm	55,90€ <sup>Incl. VAT</sup>
	HT100 Code : B00807	1" capton 300W 8 Ohm bullet tweeter	26,90€ <sup>Incl. VAT</sup>
	AXO-S6 Code : H9724	Filter for S6	22,00€ <sup>Incl. VAT</sup>
	AXO-S10 Code : H9727	Filter for S10	39,00€ <sup>Incl. VAT</sup>
	AXO-OCTAVE Code : H9394	2-way filter for OCTAVE satellite	35,00€ <sup>Incl. VAT</sup>
	AXO-SR12P Code : H10321	2-way filter for SR12P speaker	29,00€ <sup>Incl. VAT</sup>
	AXO-COMPACT500 Code : H10310	2-way filter for COMPACT-500 satellite	45,00€ <sup>Incl. VAT</sup>
	CN-12 Code : B00815	2-way professional filter (X-over freq. : 1.8kHz, Slope: 12dB/oct, RMS power: 300W)	39,90€ <sup>Incl. VAT</sup>
	CN-6 Code : B00813	High pass filter for 2-way system (X-over freq. : 4.5kHz, Slope: 18dB/oct RMS power: 100W).	10,50€ <sup>Incl. VAT</sup>



# LOUDSPEAKERS AND FILTERS

	CR25WB-200 Code : H10856	12-inch woofer for CR25A-COMBO	129,00€ <sup>Incl. VAT</sup>
	SXWB15-200 Code : H10852	15-inch 250W woofer for SX15A	49,00€ <sup>Incl. VAT</sup>
	iLINEw320 Code : H10765	HP 3" 20W for iLINE series columns	16,00€ <sup>Incl. VAT</sup>
	SRWB12-350 Code : H10161	12" 350W 4 Ohms woofer for SR12A speaker	109,00€ <sup>Incl. VAT</sup>
	SRWB12-350-8 Code : H10318	12-inch 350W 8 Ohm woofer for SR12P	119,00€ <sup>Incl. VAT</sup>
	ACW08-104 Code : H8742	8-inch woofer for ACUTE-08 / AMP	69,00€ <sup>Incl. VAT</sup>
	MIOSW6100 Code : H10151	6.5" 100W woofer for SYSTEM1 Sub	59,00€ <sup>Incl. VAT</sup>
	SW8-150 Code : H9816	8-inch woofer for S8	69,00€ <sup>Incl. VAT</sup>
	OWB6-100 Code : H9401	6.5" 8 Ohms 100 W woofer for COM-PACT and S6 satellites	49,00€ <sup>Incl. VAT</sup>
	JOG5-30 Code : H9636	5-inch 30W 4 Ohm woofer for JOGGER50	22,00€ <sup>Incl. VAT</sup>
	SPW10-120 Code : H9638	10-inch woofer 100W for SPRINTER120	69,00€ <sup>Incl. VAT</sup>
	CRW6-60 Code : H10314	6.5-inch 80W 8 Ohm woofer for CR80A	69,00€ <sup>Incl. VAT</sup>
	OWB12-400-8 Code : H9402	12-inch 400W 8 Ohm woofer for COMPACT subwoofer	159,00€ <sup>Incl. VAT</sup>
	HLWB10 Code : H10589	10-inch 8 Ohm woofer for HL-10ASUB	129,00€ <sup>Incl. VAT</sup>
	HLWB8 Code : H10588	8-inch 8 Ohm woofer for HL-08ASUB	99,00€ <sup>Incl. VAT</sup>
	CUBW12-300 Code : H10728	12-inch 300W woofer for CUBsub112	129,00€ <sup>Incl. VAT</sup>
	SRWB18-600 Code : H10733	18-inch woofer for SRSUB18A	399,00€ <sup>Incl. VAT</sup>
	COW4-60 Code : H10308	4.75-inch 80W 8 Ohm woofer for COM-PACT-500 satellite	45,00€ <sup>Incl. VAT</sup>
	PWX 12/200 Code : B00680	Woofer 12 inches / 200Wrms	61,90€ <sup>Incl. VAT</sup>
	PWX 18/400 Code : B00683	18-inch / 400Wrms woofer	174,90€ <sup>Incl. VAT</sup>
	SP-12/200 Code : B00666	12-inch / 200W woofer	25,90€ <sup>Incl. VAT</sup>

	SXWB12-200 Code : H10851	12-inch 200W woofer for SX12A	39,00€ <sup>Incl. VAT</sup>
	SRWB10-250 Code : H10160	10-inch 250W 4 Ohm woofer for SR10A speaker	69,00€ <sup>Incl. VAT</sup>
	SRWB15-350 Code : H10162	15" 350W 4 Ohms woofer for SR15A speaker	139,00€ <sup>Incl. VAT</sup>
	SRWB15-350-8 Code : H10319	15-inch 350W 8 Ohm woofer for SR15P	139,00€ <sup>Incl. VAT</sup>
	ACW08-108 Code : H9629	8-inch 8 Ohm woofer for ACUTE08 passive	69,00€ <sup>Incl. VAT</sup>
	MIOSW8150 Code : H10155	8" 150W woofer for SYSTEM2 Sub	79,00€ <sup>Incl. VAT</sup>
	SW10-250 Code : H9726	10-inch woofer for S10	139,00€ <sup>Incl. VAT</sup>
	OWB8-108 Code : H9630	8-inch 170W 8 Ohms woofer for Octave satellite	79,00€ <sup>Incl. VAT</sup>
	JOG5-40 Code : H9901	5 1/4-inch woofer for JOGGER60	25,00€ <sup>Incl. VAT</sup>
	CRW10-180 Code : H9899	10-inch woofer for CROSSER180	259,00€ <sup>Incl. VAT</sup>
	OWB15-600 Code : H9106	15" woofer used in OCTAVE, SUB115-AMP, EX15S, EX215S subwoofers	259,00€ <sup>Incl. VAT</sup>
	CW10-150 Code : H9301	10-inch woofer used in the CB-210	89,00€ <sup>Incl. VAT</sup>
	HLWB4 Code : H10587	4-inch 8 Ohms woofer for HL-4	39,00€ <sup>Incl. VAT</sup>
	MOJOLINE-08 Code : H10585	8-inch woofer for MOJ0500LINE	79,00€ <sup>Incl. VAT</sup>
	CUBW08-150 Code : H10729	8-inch 150W woofer for CUBsub208	109,00€ <sup>Incl. VAT</sup>
	COWB10-300 Code : H10307	10-inch 300W 4 Ohm woofer for COM-PACT-500 subwoofer	149,00€ <sup>Incl. VAT</sup>
	PWX 10/200 Code : B00679	10-inch / 200Wrms woofer	39,90€ <sup>Incl. VAT</sup>
	PWX 15/300 Code : B00681	15-inch / 300Wrms woofer	92,90€ <sup>Incl. VAT</sup>
	SP-10/150 Code : B00665	10-inch / 150W woofer	20,90€ <sup>Incl. VAT</sup>
	SP-15/250 Code : B00667	15-inch / 250W woofer	44,90€ <sup>Incl. VAT</sup>



# LAMPS

	LPAR36/4515 Code : H0132	GE lamp PAR36 6V 30W 4515	8,60€ <sup>Incl. VAT</sup>
	LPAR56/WFL Code : H8662	GE lamp PAR56 240V 300W 37° x 20°	16,90€ <sup>Incl. VAT</sup>
	MASTER LEDspot PAR20 DIM Code : B06501	PHILIPS LED LAMP 6W--2700K- E27-25°-DIM	14,90€ <sup>Incl. VAT</sup>
	MASTER LEDspot PAR38 DIM Code : B06503	PHILIPS LED LAMP 13W-2700K- E27-25°-DIM	29€ <sup>Incl. VAT</sup>
	GY9.5500 Code : H0296	Philips lamp CP82 240V 500W	13,90€ <sup>Incl. VAT</sup>
	GX9.51000 Code : H0295	Lamp CP70 240V 1000W	15,90€ <sup>Incl. VAT</sup>
	LR7S/118-500 Code : H9011	Lamp R7S 240V 500W 2900°K 2000H	1,90€ <sup>Incl. VAT</sup>
	LHID-150 Code : H8984	Lamp type HID-150 95V 150W 6500 °K 1000H	89,00€ <sup>Incl. VAT</sup>
	L2R Code : H10165	Philips® MSD Platinum 2R lamp	209,00€ <sup>Incl. VAT</sup>
	SIRIUS HRI 280W FS1 Code : B02179	OSRAM Metal halogen lamp, 280Watt, 2000h, 7800K	299,00€ <sup>Incl. VAT</sup>
	LMSD-250/2 Code : H8994	Lamp type MSD-250-2 94V 250W 8000°K 2000H	79,00€ <sup>Incl. VAT</sup>
	LBVM1 Code : H9006	Lamp type BVM 120V 300W 3200°K 150H	3,90€ <sup>Incl. VAT</sup>
	LBVM3 Code : H9007	Lamp type BVM 240V 300W 3200°K 75H	4,50€ <sup>Incl. VAT</sup>
	G6.3540036 Code : H0626	Osram lamp EVD 36V 400W	5,70€ <sup>Incl. VAT</sup>
	LEFR Code : H9009	Lamp type EFR 15V 150W 3400°K 50H	6,70€ <sup>Incl. VAT</sup>
	ELC25024 Code : H3119	Philips lamp ELC 24V 250W	7,20€ <sup>Incl. VAT</sup>
	ENH250120 Code : H0177	Osram lamp ENH 120V 250W	8,90€ <sup>Incl. VAT</sup>

	LPAR56/MFL Code : H0131	Osram lamp PAR56 240V 300W	16,90€ <sup>Incl. VAT</sup>
	MASTER LEDspot PAR16 DIM Code : B06500	PHILIPS LED LAMP 3.7W-2700K-GU10-25°-DIM	8,90€ <sup>Incl. VAT</sup>
	MASTER LEDspot PAR30 DIM Code : B06502	PHILIPS LED LAMP 9.5W-2700K-E27-25°-DIM	21,90€ <sup>Incl. VAT</sup>
	LED-GU10-5W-WW-38D Code : B02258	LED lamp GU10, 5W - 240Vac DIM, warm white, 38°	14,90€ <sup>Incl. VAT</sup>
	GY9.5650 Code : H0297	GE lamp T26 240V 650W	13,90€ <sup>Incl. VAT</sup>
	GX9.51000/T19 Code : H2590	Lamp T19 240V 1000W	15,90€ <sup>Incl. VAT</sup>
	HPL 575-X LL 230v Code : B02171	GE Lighting Halogen lamp, no reflector, 575W/230V, sp. socket	29,00€ <sup>Incl. VAT</sup>
	LHRI100 Code : H10432	OSRAM SIRIUS HRI lamp 100W,6000h,9000°K	95,00€ <sup>Incl. VAT</sup>
	L5R Code : H10357	Philips MSD Platinum 5R lamp	249,00€ <sup>Incl. VAT</sup>
	L15R Code : H10358	Philips MSD Platinum 15R lamp	499,00€ <sup>Incl. VAT</sup>
	MSD250/2-05 Code : H3425	Osram lamp MSD 250W	99,00€ <sup>Incl. VAT</sup>
	G6.35300110 Code : H1247	Osram lamp 64514 120V 300W	7,50€ <sup>Incl. VAT</sup>
	G6.35300220 Code : H0628	Osram lamp 64516 240V 300W	7,70€ <sup>Incl. VAT</sup>
	EFP10012 Code : H0624	Philips or Osram lamp EFP 12V 100W	5,70€ <sup>Incl. VAT</sup>
	LELC Code : H9008	Lamp type ELC 24V 250W 3200°K 50H	6,20€ <sup>Incl. VAT</sup>
	LELC/LD Code : H8986	lamp type ELC 24V 250W 3200 °K 300H	8,90€ <sup>Incl. VAT</sup>
	LST/1500 Code : H9021	Lamp strobe type-3 1500W 5600°K 500H 120Hz max	25,90€ <sup>Incl. VAT</sup>





[WWW.AUDIOPHONY.COM](http://WWW.AUDIOPHONY.COM)



[WWW.CONTEST-LIGHTING.COM](http://WWW.CONTEST-LIGHTING.COM)



[WWW.BRITEQ-LIGHTING.COM](http://WWW.BRITEQ-LIGHTING.COM)



[WWW.JB-SYSTEMS.EU](http://WWW.JB-SYSTEMS.EU)



[WWW.SYNQ-AUDIO.COM](http://WWW.SYNQ-AUDIO.COM)



[WWW.HILEC.EU](http://WWW.HILEC.EU)

The advertised prices are VAT-inclusive prices, calculated with the VAT in force in the country of distribution.

See conditions at your retailer. Within the limits of available stocks. Information is subject to typographical errors. The technical specifications, photos, illustrations and prices in this catalogue are not binding. In order to improve our products, modifications can be made. In accordance with the legislation in force, it is up to each retailer to freely set its selling prices. Prices are subject to change without notice. The prices invoiced, in particular, are those of the tariff in force on the day of delivery. Catalogue in effect as of March 12, 2018.

AUDIOPHONY®, CONTEST®, JBSYSTEMS®, BRITEQ®, JV CASE® and SYNQ® are registered trademarks of HITMUSIC SAS and BEGLEC NV.

Any reproduction of the catalogue, even partial, or use of the logos or design of the intellectual property is prohibited, without prior written permission from HIT MUSIC SAS and/or BEGLEC NV.

Catalogue published by HIT MUSIC SAS - Parc d'Activités CAHORS SUD - EN TESTE - 46230 FONTANES - France.  
Product photo credits : Studio ZE and BEGLEC NV. - Ambience photo credits : © Shutterstock - Creation: Agence NOVO & HITMUSIC SAS

MKT-CATA2018  
ANG / AVEC PRIX



3 662009 019499

code H10891